

TOV



Follow us!

Show your new purchase some love by tagging it on our Instagram!

 @tovfurniture

 516-888-3355

 hello@tovfurniture.com

 www.tovfurniture.com

If the future is female—your furniture should be, too. No mahogany in sight. Sexy settees shaped like lips. Price points for any budget. At TOV, we do things differently.

TOV

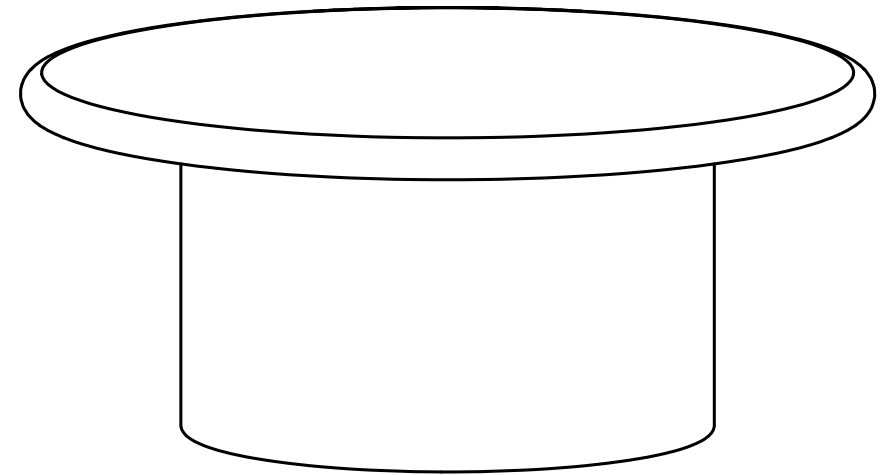

Byron Coffee Table

DON'T BE BORING.

Step 3

Assembly is complete. Enjoy!

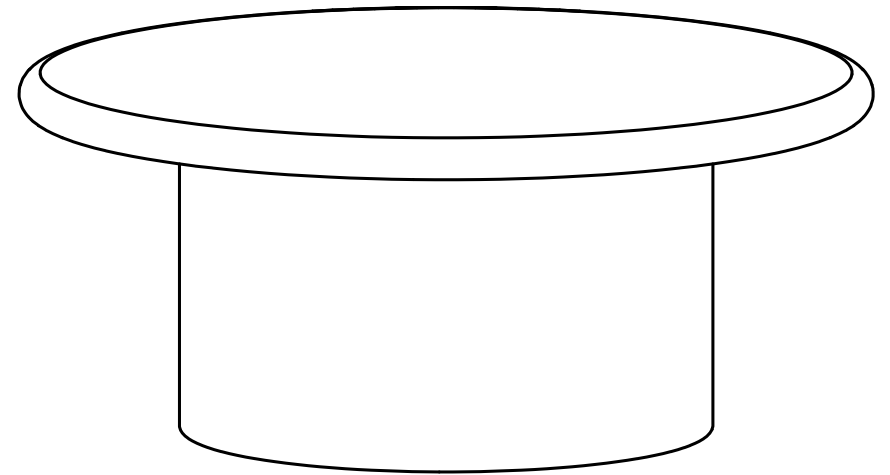





Stuck?

Contact our team @ 516-888-3355

Scan for product care!

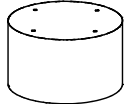

Hardware and Components

-  **A** Top x 1pcs
-  **B** Base x 1pcs
-  **C** x 4pcs Bolt (M8*45mm)
-  **D** x 4pcs Washer (Ø12*1.5mm)
-  **E** x 4pcs Washer (Ø22*2.0mm)
-  **F** x 1pcs Allen Key (4mm)

Step 1

Open box of hardware and legs.

This hardware box will be a smaller box inside of the main box. Look for the red streamer.



Step 2

- A.** Place table top (A) face down on the floor.
- B.** Secure the table base (B) to table top (A) with hardware (C), (D), (E) & (F).

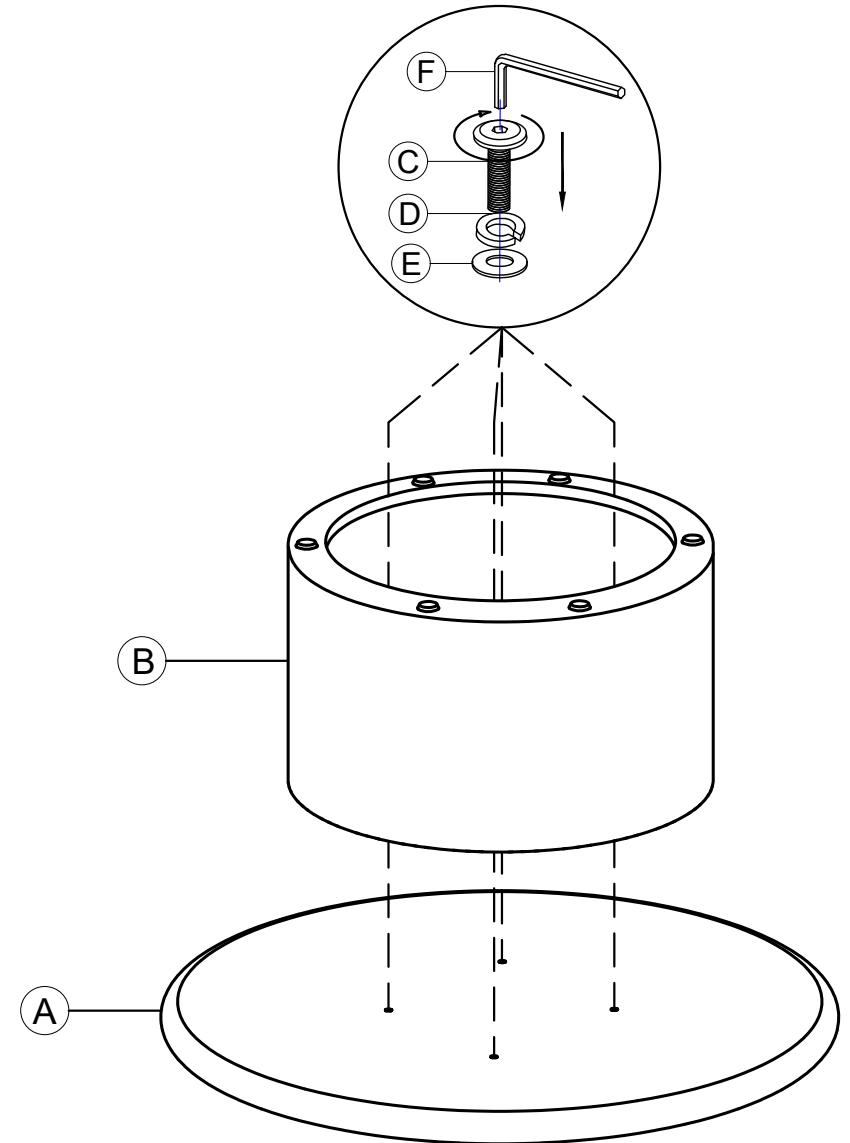

Start by tightening the bolts at 70%, and once all screws are in place, tighten them fully.