

TOV



Follow us!

Show your new purchase some love by tagging it on our Instagram !

 @tovfurniture

 516-888-3355

 hello@tovfurniture.com

 www.tovfurniture.com

If the future is female—your furniture should be, too. No mahogany in sight. Sexy settees shaped like lips. Price points for any budget. At TOV, we do things differently.

TOV

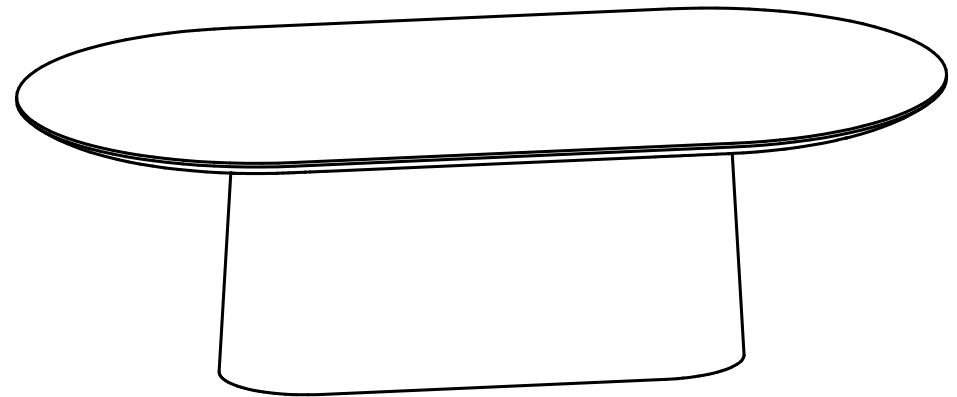

Nara Dining Table

DON'T BE BORING.



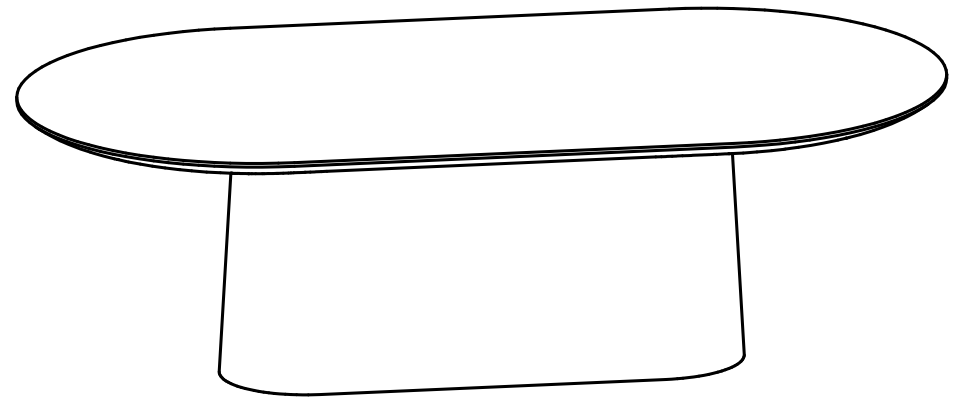





Step 3
Assembly is complete. Enjoy!



Stuck?
Contact our team @ 516-888-3355
Scan for product care!



Hardware and Components

-  (A) Top x 1pcs
-  (B) Connection Piece x 2pcs
-  (C) Base x 1pcs
-  (D) Bolt M8*20 x 6pcs
-  (E) Bolt M8*25 x 6pcs
-  (F) Spring Washer Ø12*1.5x 6pcs
-  (G) Washer Ø22*2 x 6pcs
-  (H) Allen key x 1pcs

Step 1
Open box of hardware and legs.

This hardware box will be a smaller box inside of the main box. Look for the red streamer.

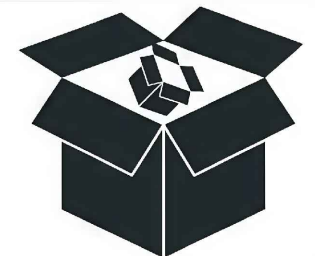

Step 2

- 1) Attach the connection piece (B) to the base (C) with the included hardware (D) and Allen key (H).
- 2) Secure the base (C) to the top (A) with hardware (E), (F),(G) & (H).

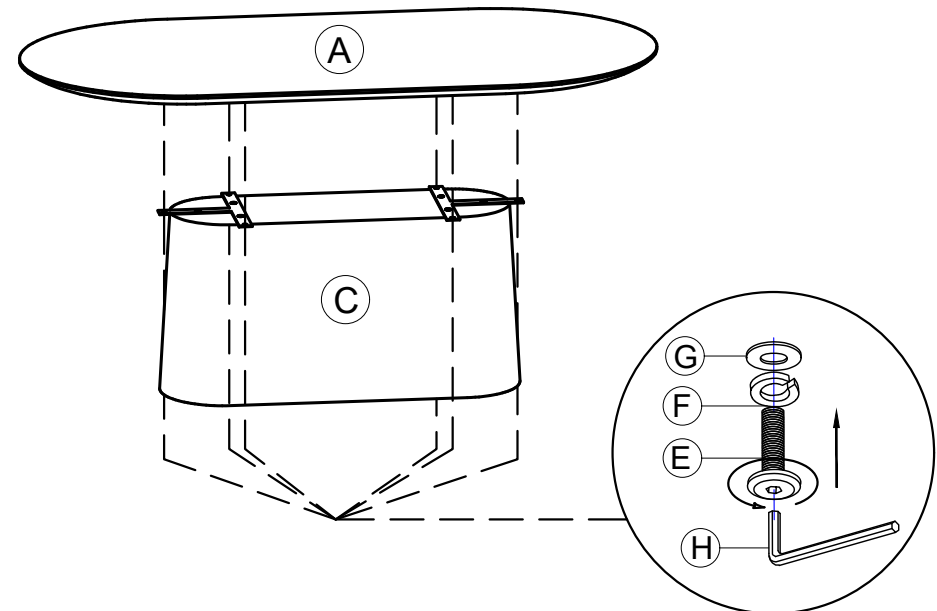
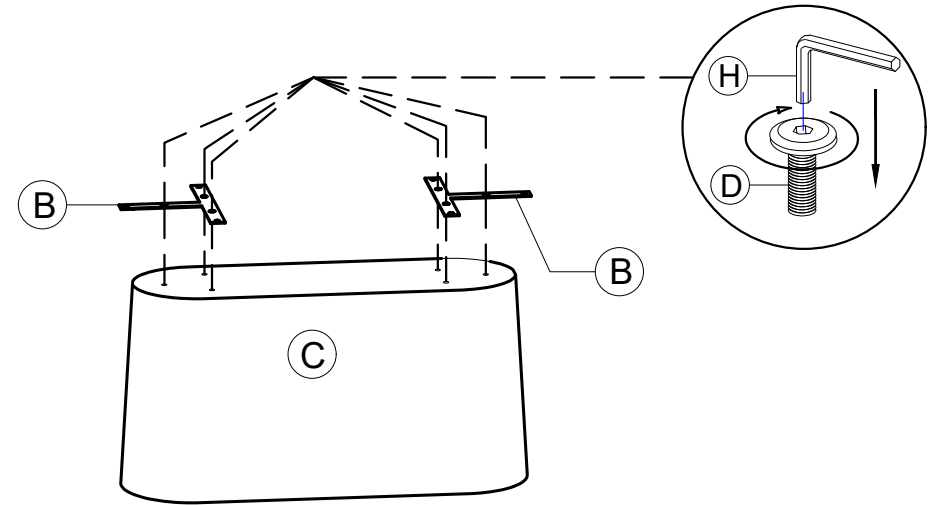

Start by tightening the bolts at 70%, and once all screws are in place, tighten them fully.