

TOV



Follow us!

Show your new purchase some love by tagging it on our Instagram!

 @tovfurniture

 516-888-3355

 hello@tovfurniture.com

 www.tovfurniture.com

If the future is female—your furniture should be, too. No mahogany in sight. Sexy settees shaped like lips. Price points for any budget. At TOV, we do things differently.



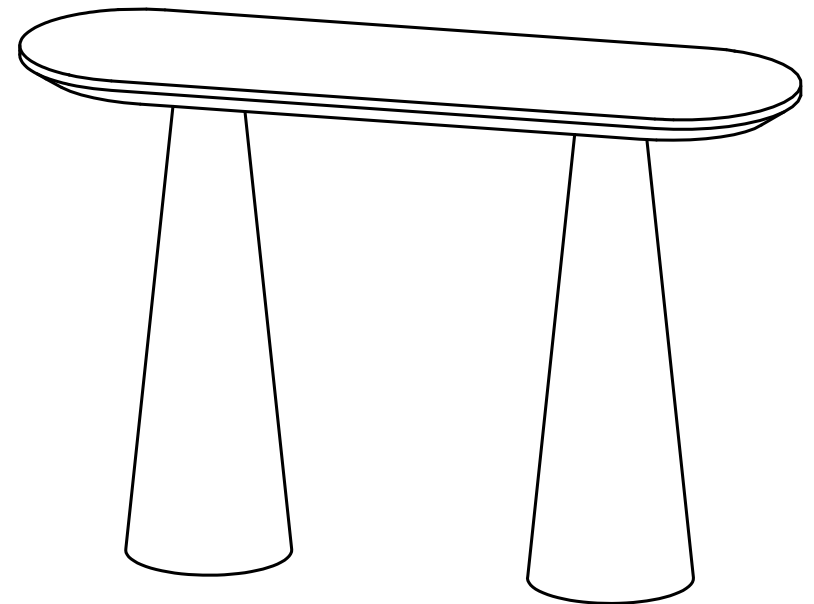



TOV

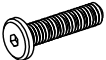

Sandra Console Table

DON'T BE BORING.

Hardware and Components

-  (A) Top x 1pcs
-  (B) Base x 2pcs
-  (C) Bolt M8*25 x 6pcs
-  (D) Washer Ø22*2 x 6pcs
-  (E) Washer Ø12*1.5 x 6pcs
-  (F) Allen key x 1pcs

Step 1
Open box of hardware and legs.

This hardware box will be a smaller box inside of the main box. Look for the red streamer.



Step 2

- 1) Place the table top (A) upside down and align the two bases (B) with the per-drilled holes
- 2) Secure the bases (B) to the top (A) with the included hardware (C) ,(D) & (E) with the included Allen key (F)

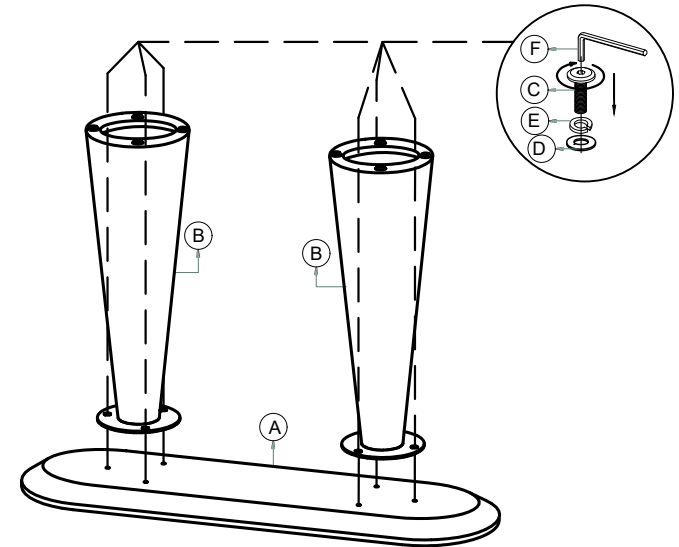

Start by tightening the bolts at 70%, and once all screws are in place, tighten them fully

Step 3

Assembly is complete .Enjoy!

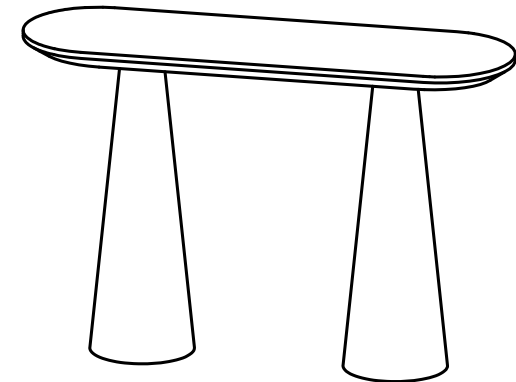

Stuck?

Contact our team @ 516-888-3355

Scan for product care!

