



TOV





Follow us!

Show your new purchase some love by tagging it on our Instagram !

 @tovfurniture

 516-888-3355

 hello@tovfurniture.com

 www.tovfurniture.com

If the future is female - your furniture should be, too. No mahogany in sight. Sexy settees shaped like lips. Price points for any budget. At TOV, we do things differently.

TOV

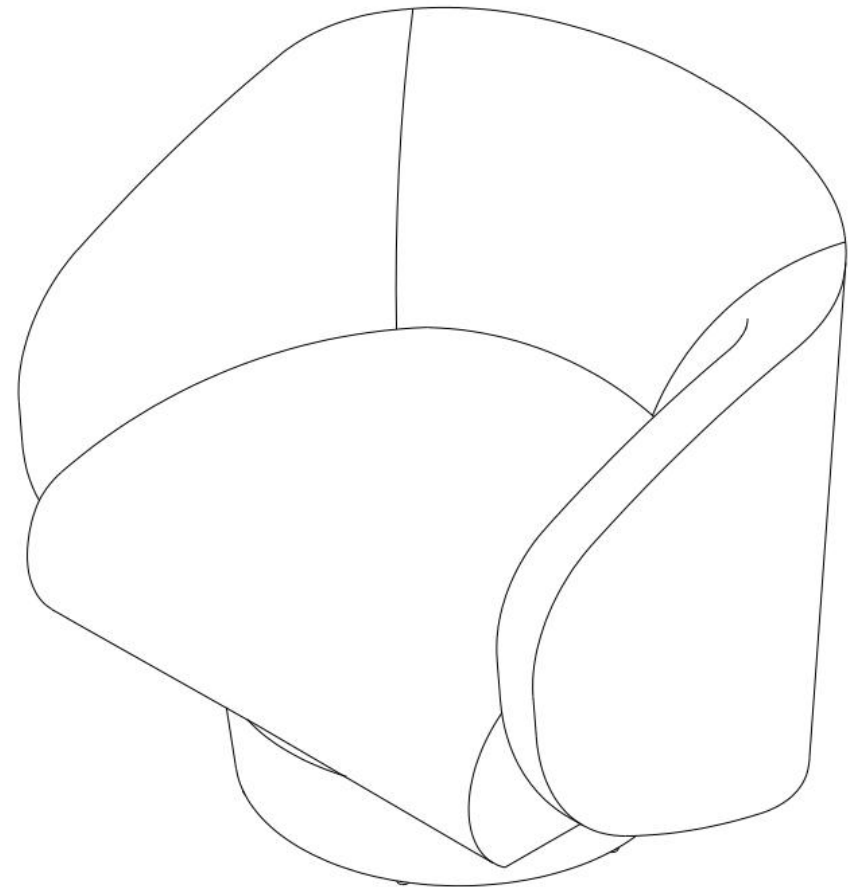

Presley Swivel Accent Chair

DON'T BE BORING.

Hardware and Components

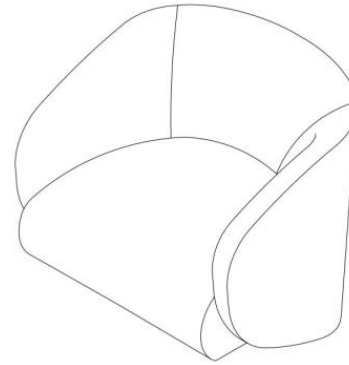

----- **A** x1pc

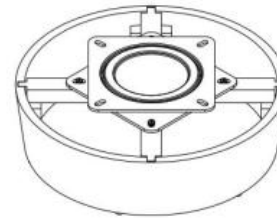

----- **B** x1pc



----- **C** x4pcs



----- **D** x4pcs



----- **E** x1pc

STEP 1

Open box of hardware and legs.

This hardware box will be a smaller box inside of the main box. Look for the red streamer.



STEP 2

Turn over seat (A), open the zipper on base (B), connect the base with hardware (C) & (D) by wrench (E)

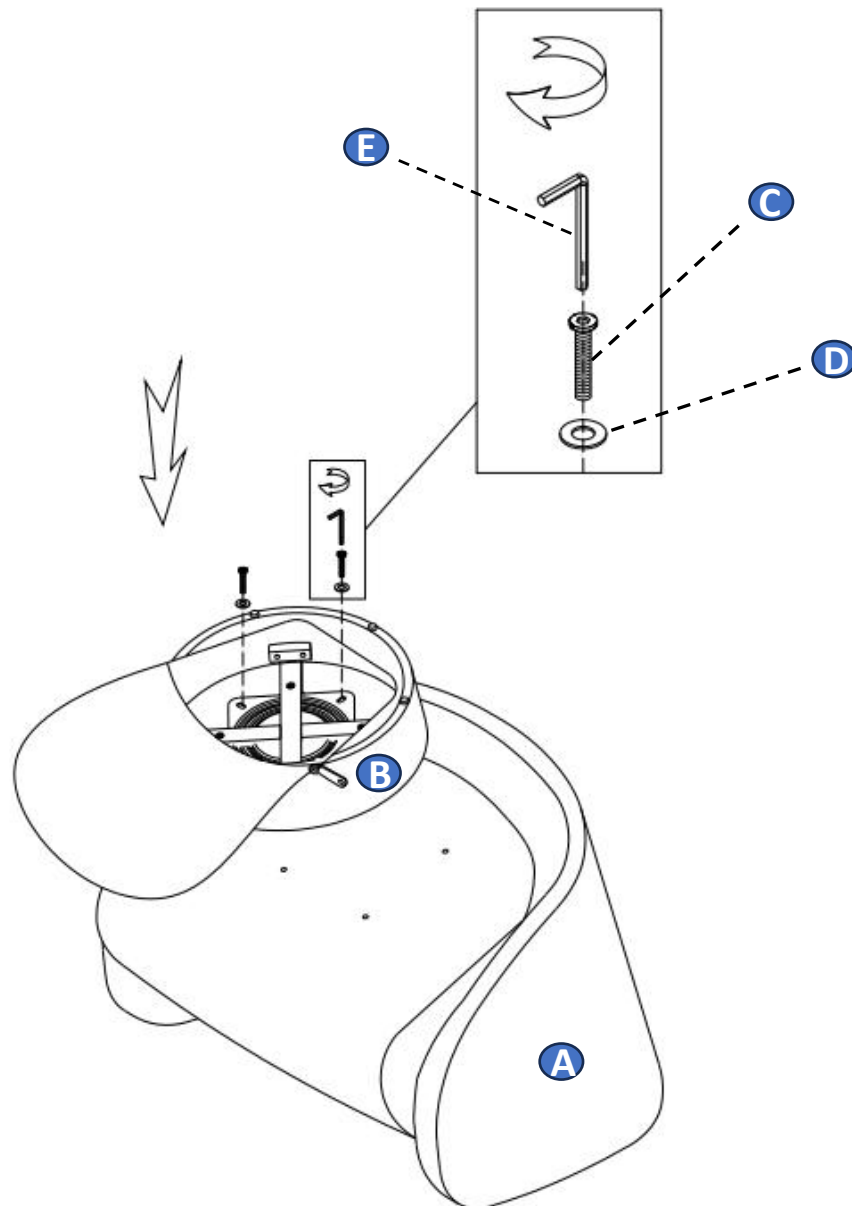

STEP 3 Complete

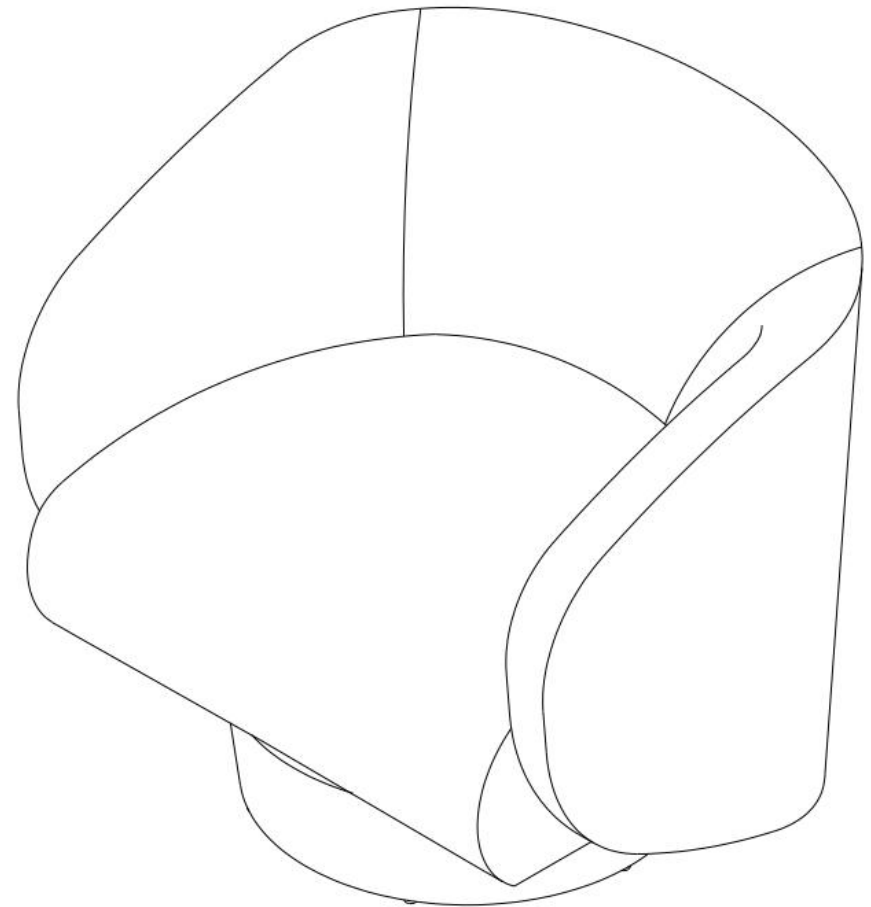

Stuck?
Contact our team @ 516-888-3355
Scan for product care!

