



ASSEMBLY INSTRUCTIONS

Wall-Mount Headboard

MOD-7339 / V0.01.07.26

modway



Questions? Contact us!

609.256.9000

cs@modway.com

Welcome.

Let's get started.

Before you begin, here are some things to keep in mind:

Assembly will take most people **about 30 minutes**. Consider having a friend help you!

Only use hand tools to assemble this item.

Do not use power tools. Do not tighten bolts or screws completely until all hardware is lined up and inserted into the holes.

Read through all of the instructions before starting. Make sure you have all parts and components before discarding any packing materials.

Do not over-tighten screws and bolts to avoid stripping the hardware or cracking the item.

Assemble your item on a flat, carpeted area, with plenty of space to work. This will prevent damage and scratches to your floors or the item while you're assembling the product.

Keep all components and packaging out of reach of children or animals to avoid risk of choking or suffocation.

Care instructions are listed in the last step of this manual.

WAIT!

Missing parts or hardware? Need assistance?

Contact us before returning your item.

We're here to help!



HARDWARE INCLUDED IN THE BOX:

A		PVC Wall plug	X2
B		Screw #8 x 50mm	X2

WHAT YOU NEED:



YOU MAY ALSO NEED:

1. **Power Drill**
2. **Level**

COMPONENT IN THE BOX :



STEP 01

1. Prepare the wall plugs, screws, screwdriver, and power drill.
2. Drill holes in the wall using a power drill with a 3 mm drill bit.
3. Adjust the drilling height according to the height of the mattress. The distance between the holes should also match the position of the brackets already installed on the headboard.
4. Insert the wall plugs by gently tapping them with a hammer until they are fully seated in the holes.
5. Install the screws using a screwdriver, but leave the screw heads protruding about 0.5 cm so the brackets can be attached and secured.
6. Insert the headboard bracket through the larger opening, push it in until fully engaged, then press it downward to lock it into place.
7. Ensure that the headboard is securely attached.

HARDWARE :

A PVC Wall plug x2

B Screw #8 x 50mm x2

COMPONENTS

1 Bedhead x1

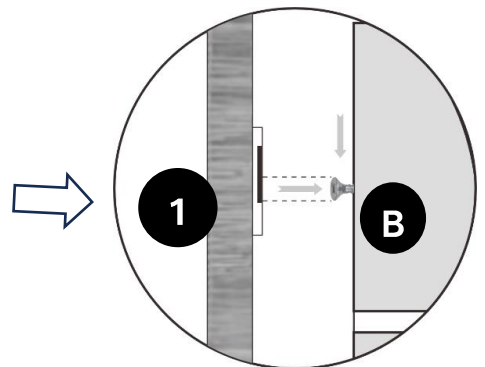
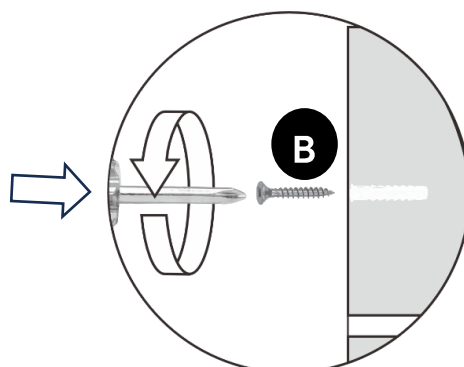
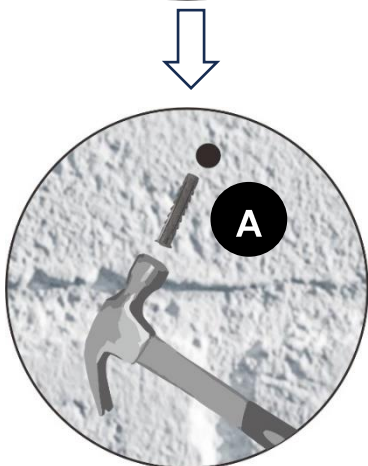
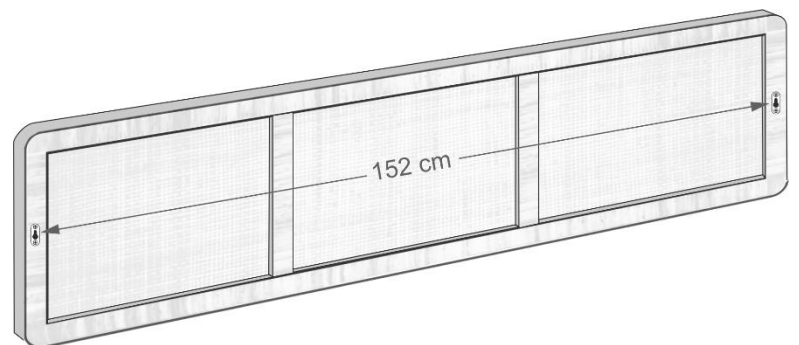
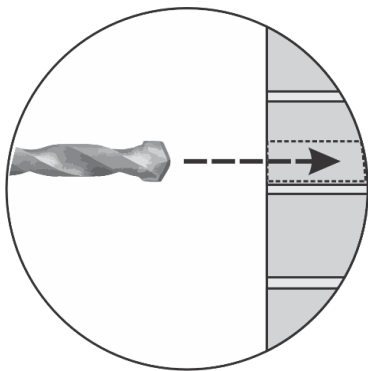
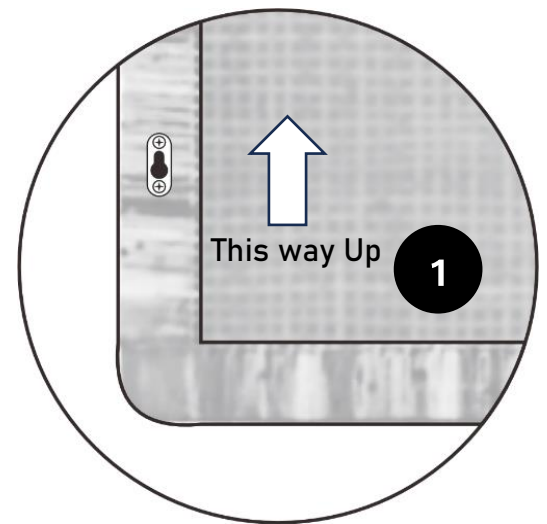

Great job!

Your new Headboard is complete.

CARING FOR YOUR ITEM

- Indoor use only
- Not contract grade.
- Clean using a non-abrasive cloth and a mild cleaner.
- Never use harsh chemicals, as they could damage the finish or integrity of the item.

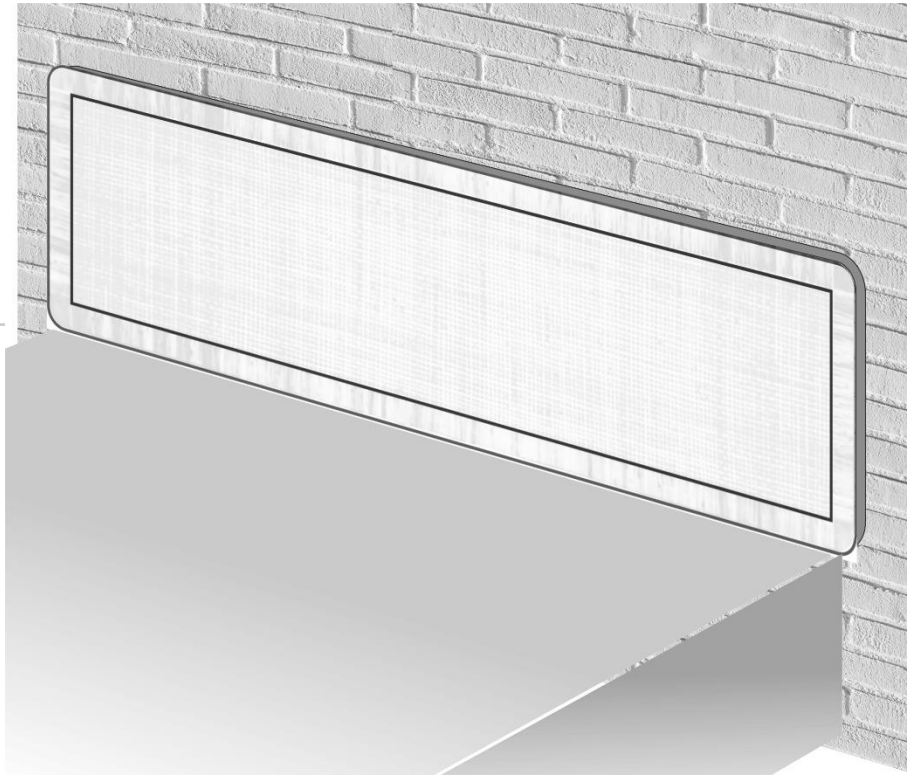

CONNECT WITH US!

Tag us [@modway_furniture](#) and [#modway](#)

for a chance to be featured.

modway



Questions? Contact us!

609.256.9000

cs@modway.com