

ASSEMBLY INSTRUCTIONS

# Headboard

MOD-7326, MOD-7327, MOD-7328 / V0.01.15.26

---

**modway**



Questions? Contact us!

609.256.9000

[cs@modway.com](mailto:cs@modway.com)

# Welcome.

## Let's get started.

Before you begin, here are some things to keep in mind:

Assembly will take most people **about 30 minutes**. Consider having a friend help you!

**Only use hand tools to assemble this item.** Do not use power tools. Do not tighten bolts or screws completely until all hardware is lined up and inserted into the holes.

**Read through all of the instructions before starting. Make sure you have all parts and components before discarding any packing materials.**

Do not over-tighten screws and bolts to avoid stripping the hardware or cracking the item.

Assemble your item on a flat, carpeted area, with plenty of space to work. This will prevent damage and scratches to your floors or the item while you're assembling the product.

Keep all components and packaging out of reach of children or animals to avoid risk of choking or suffocation.

**Care instructions are listed in the last step of this manual.**

**WAIT!**







Missing parts or hardware? Need assistance?  
Contact us before returning your item.  
We're here to help!



## HARDWARE INCLUDED IN THE BOX: FOR HEADBOARD

1		JCBB Bolt M8 x 40mm	x4
2		M8 Flat Washer	x4
3		M5 Allen Key	x1

## HARDWARE INCLUDED IN THE BOX: FOR BED FRAME

4		JCBB Bolt M6 x 60mm	x4
5		JCBB Bolt M6 x 35mm	x4
6		M6 Flat Washer	x8
7		M6 Spring Washer	x4
8		M6 Hex Nut	x4
9		M4 Allen Key	x1

## FURNITURE COMPONENTS:

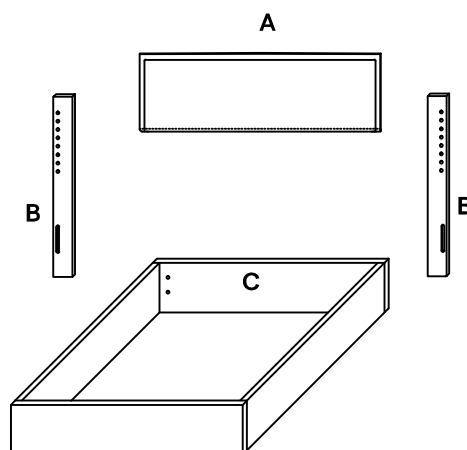

A	Headboard	x1
B	Leg Post	x2
C	Bed Frame - Sold Separately	x1

## HEADBOARD ONLY ASSEMBLY

## STEP 01

## COMPONENTS

<b>A</b>	Headboard	x1
<b>B</b>	Leg Post	x2

Open the cover first, then unzip the headboard back and take out the leg and hardware.

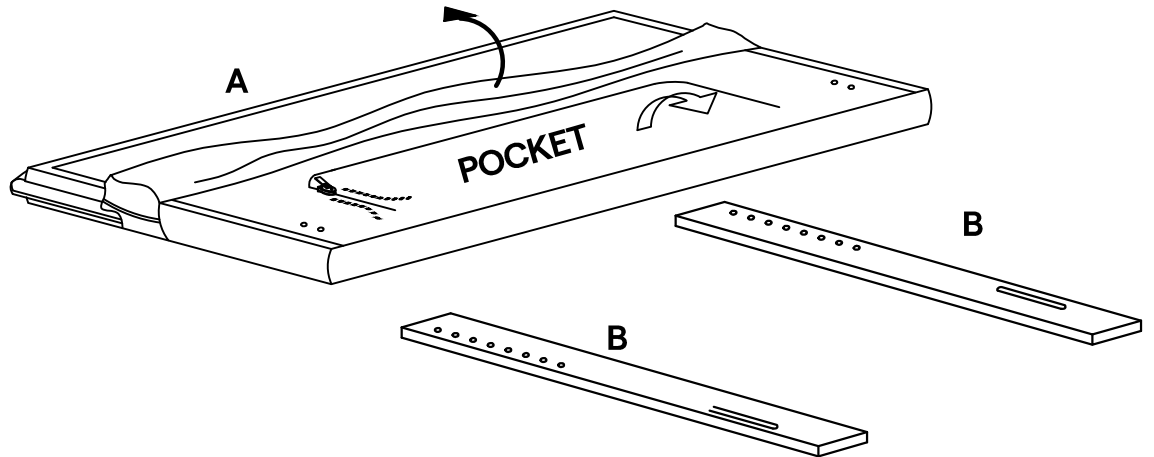

## STEP 02

## HARDWARE

<b>1</b>	JCBB Bolt M8 x 40mm	x4
<b>2</b>	M8 Flat Washer	x4
<b>3</b>	M5 Allen Key	x1

## COMPONENTS

<b>A</b>	Headboard	x1
<b>B</b>	Leg Post	x2

Assemble headboard holes according to your desired headboard size and height.

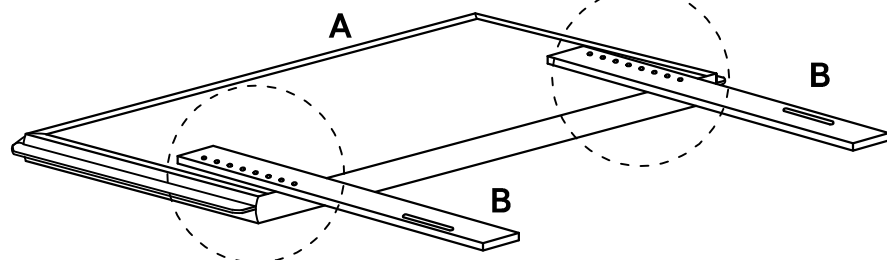
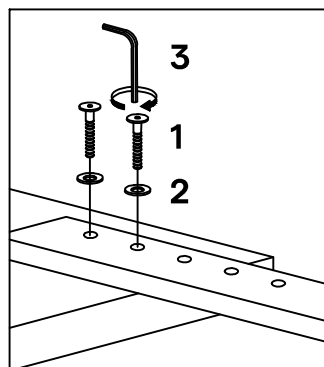

# HEADBOARD + BEDFRAME ASSEMBLY

## STEP 03

### HARDWARE

- 4 JCBB Bolt M6 x 60mm x4
- 5 JCBB Bolt M6 x 35mm x4
- 6 M6 Flat Washer x8
- 7 M6 Spring Washer x4
- 8 M6 Hex Nut x4
- 9 M4 Allen key x1

### COMPONENTS

- A Headboard x1
- B Leg Post x2
- C Bed Frame - Sold Separately x1

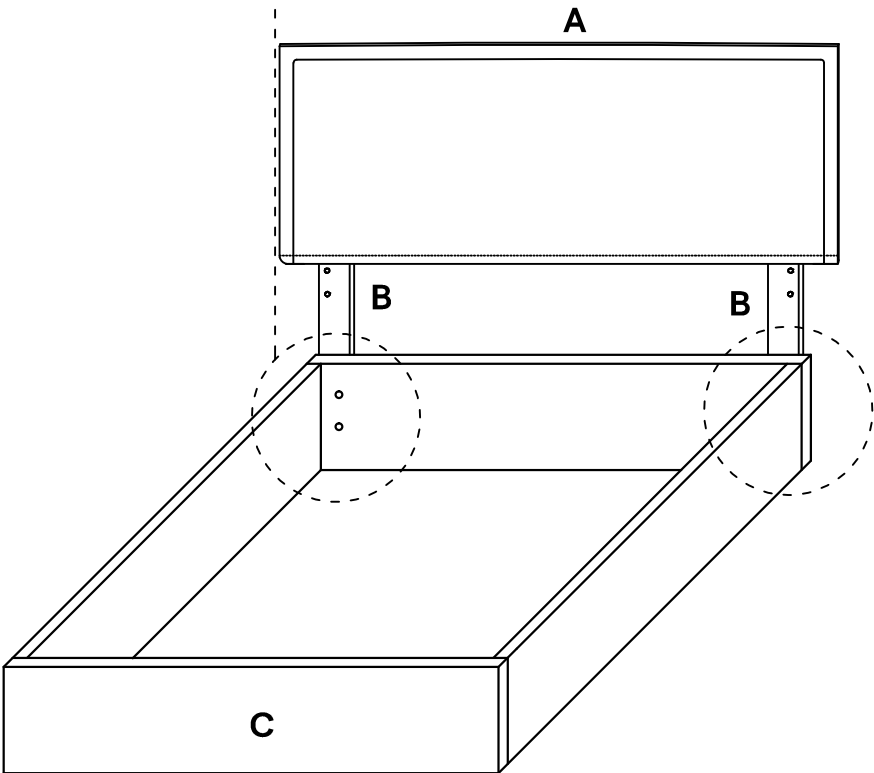
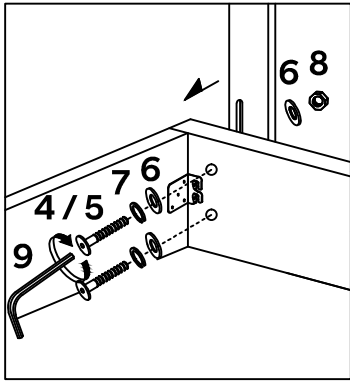

# Great job!

Headboard and bed-frame assembly is complete.

---

## CARING FOR YOUR ITEM

- Indoor use only.
- Not contract grade.
- Clean using a non-abrasive cloth and a mild cleaner.
- Never use harsh chemicals, as they could damage the finish or integrity of the item.

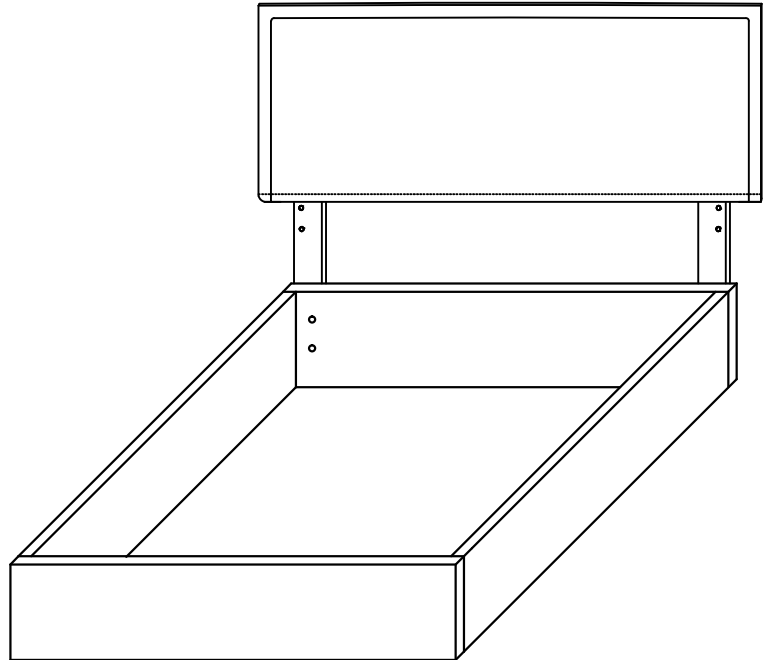

## CONNECT WITH US!

Tag us [@modway\\_furniture](#) and [#modway](#) for a chance to be featured.

# modway



Questions? Contact us!  
609.256.9000  
[cs@modway.com](mailto:cs@modway.com)