

TOV



Follow us!

Show your new purchase some love by tagging it on our Instagram!

 @tovfurniture

 516-888-3355

 hello@tovfurniture.com

 www.tovfurniture.com

CARE & MAINTENANCE

Do not use polishes or cleaners on your Table
USE DRY CLOTH TO CLEAN.

Thank you for purchasing the **Corrine Table Lamp**
This page lists all contents included in the box.
Please take time to identify all the parts of this product.
As you unpack and prepare for assembly, place
the contents on a carpeted or padded area to protect them
from damage.

TOV

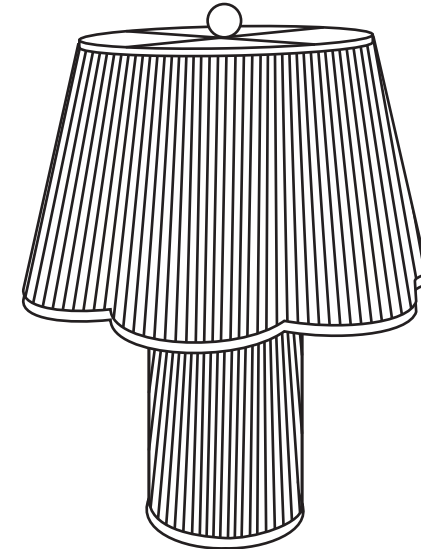

CORRINE Table Lamp

DON'T BE BORING.

Hardware and Components

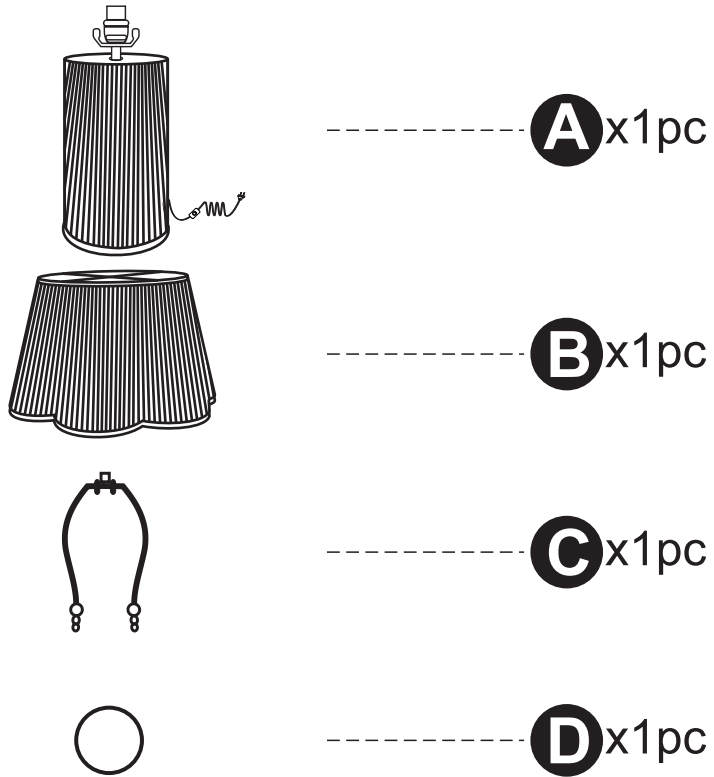

Step 1

Squeeze the harp (C) legs together to connect them to the saddle base (A)

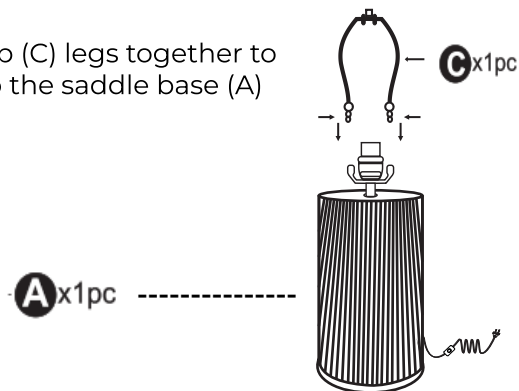

Step 2

Place shade (B) on the harp (C)

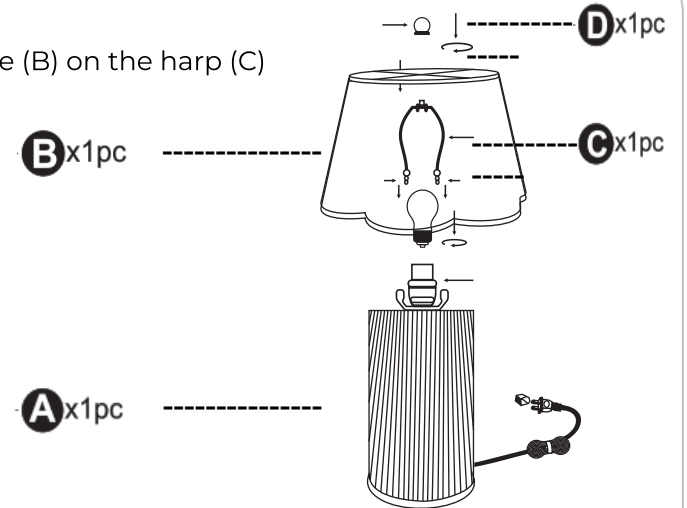

Step 3

Screw the finial (D) onto the harp (C) to secure the lampshade (B) in place

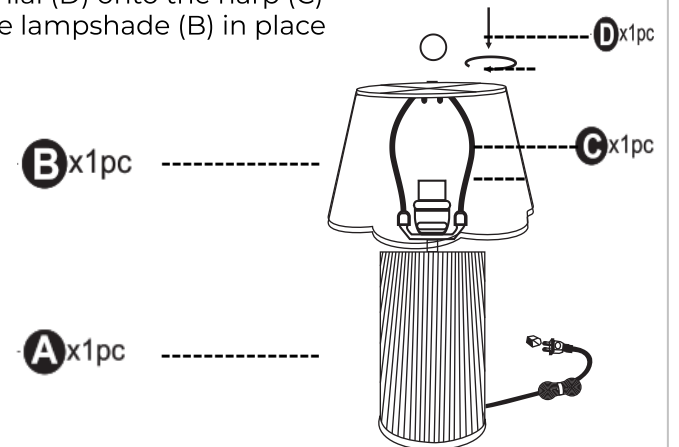

Stuck?

Contact our team @ 516-888-3355

Scan for product care!



TOV



Follow us!

Show your new purchase some love by tagging it on our Instagram!

 @tovfurniture

 516-888-3355

 hello@tovfurniture.com

 www.tovfurniture.com

If the future is female—your furniture should be, too. No mahogany in sight. Sexy settees shaped like lips. Price points for any budget. At TOV, we do things differently.

TOV

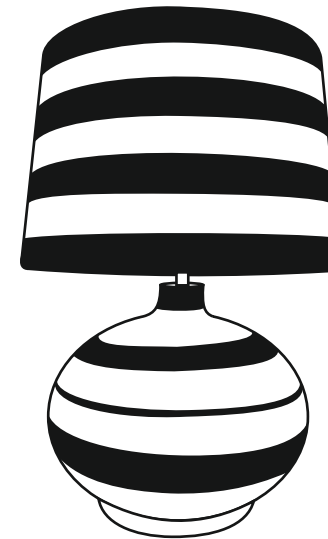

Positano Table Lamp

DON'T BE BORING.

Hardware and Components

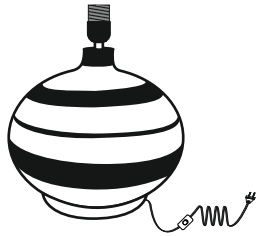

A x1pc

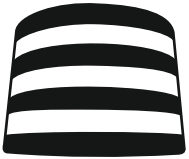

B x1pc



C x1pc

Step 1

Unscrew the holder ring.

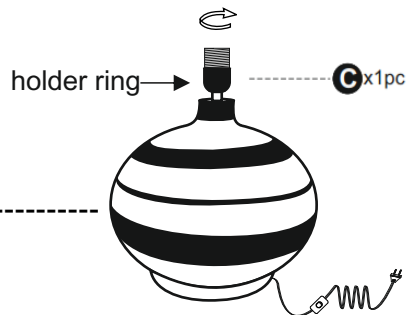

Step 2

Place shade on the lamp base.

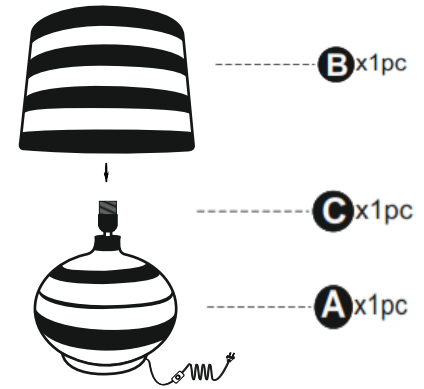

Step 3

Tighten the holder ring.

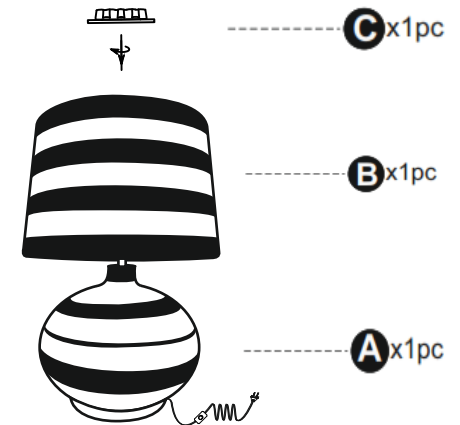

Stuck?

Contact our team @ 516-888-3355

Scan for product care!



TOV



Follow us!

Show your new purchase some love by tagging it on our Instagram!

 @tovfurniture

 516-888-3355

 hello@tovfurniture.com

 www.tovfurniture.com

If the future is female—your furniture should be, too. No mahogany in sight. Sexy settees shaped like lips. Price points for any budget. At TOV, we do things differently.

TOV

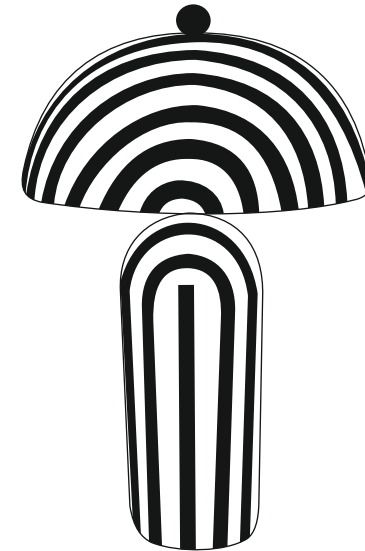

Maiori Table Lamp

DON'T BE BORING.

Hardware and Components

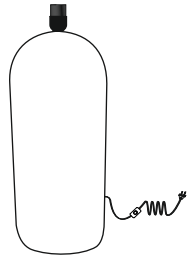

----- **A** x1pc

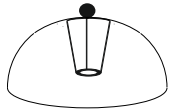

----- **B** x1pc



----- **C** x1pc

Step 1

Unscrew the holder ring.

holder ring → **C** x1pc

A x1pc



Step 2

Place shade frame on the lamp base.

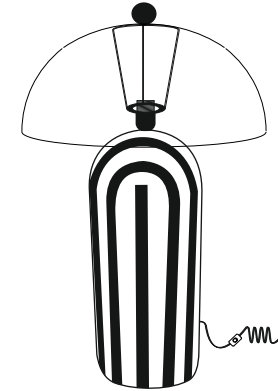

----- **B** x1pc

----- **C** x1pc

----- **A** x1pc

Step 3

Tighten the holder ring.

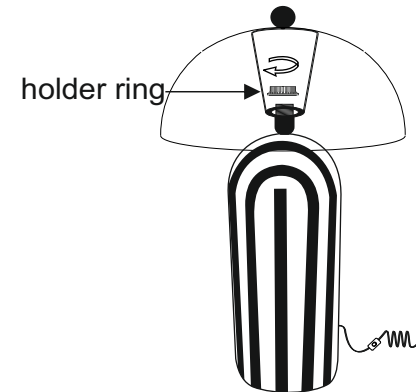

holder ring →

----- **B** x1pc

----- **C** x1pc

----- **A** x1pc

Stuck?
Contact our team @ 516-888-3355

Scan for product care!



TOV



Follow us!

Show your new purchase some love by tagging it on our Instagram!

 @tovfurniture

 516-888-3355

 hello@tovfurniture.com

 www.tovfurniture.com

If the future is female—your furniture should be, too. No mahogany in sight. Sexy settees shaped like lips. Price points for any budget. At TOV, we do things differently.

TOV

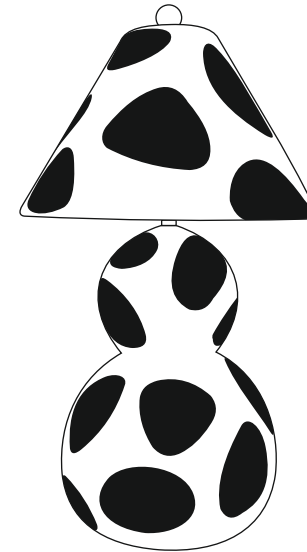

Lerici Table Lamp

DON'T BE BORING.

Hardware and Components



----- **A**x1pc

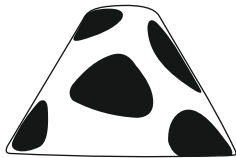

----- **B**x1pc



----- **C**x1pc



----- **D**x1pc

Step 1

Squeeze the harp (C) legs together to connect them to the saddle base (A)

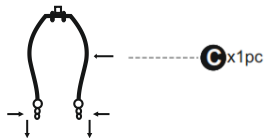

Ax1pc -----



Step 2

Place shade (B) on the harp (C)

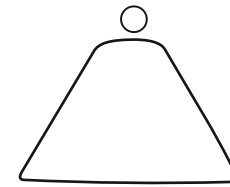

----- **D**x1pc

----- **B**x1pc

----- **C**x1pc

----- **A**x1pc

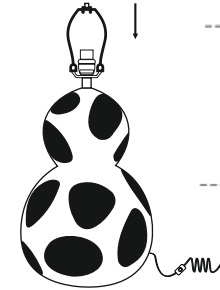

Step 3

Screw the finial (D) onto the harp (C) to secure the lampshade (B) in place

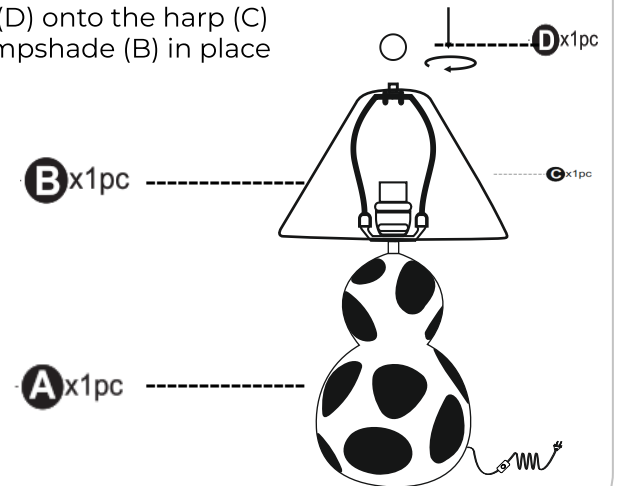

Bx1pc -----

Ax1pc -----

Stuck?

Contact our team @ 516-888-3355

Scan for product care!

