

ASSEMBLY INSTRUCTIONS

# Outdoor Dining Table

EEl-7624 / V0.26.01.26

---

**modway**



Questions? Contact us!

609.256.9000  
cs@modway.com

# Welcome.

## Let's get started.

Before you begin, here are some things to keep in mind:

Assembly will take most people **about 30 minutes**. Consider having a friend help you!

**Only use hand tools to assemble this item.** Do not use power tools. Do not tighten bolts or screws completely until all hardware is lined up and inserted into the holes.

**Read through all of the instructions before starting. Make sure you have all parts and components before discarding any packing materials.**

Do not over-tighten screws and bolts to avoid stripping the hardware or cracking the item.

Assemble your item on a flat, carpeted area, with plenty of space to work. This will prevent damage and scratches to your floors or the item while you're assembling the product.

Keep all components and packaging out of reach of children or animals to avoid risk of choking or suffocation.





**Care instructions are listed in the last step of this manual.**

**WAIT!**

**Missing parts or hardware? Need assistance?**  
Contact us before returning your item.  
We're here to help!

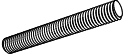

## HARDWARE INCLUDED IN THE BOX:

A		Bolt M8 x 25mm	x4
B		Spring Washer M8 ø12 x 2mm	x4
C		Washer M8 ø23 x 1mm	x4
D		Allen Key	x1
E		Located Bolt M8 x 50mm	x2

## FURNITURE COMPONENTS:

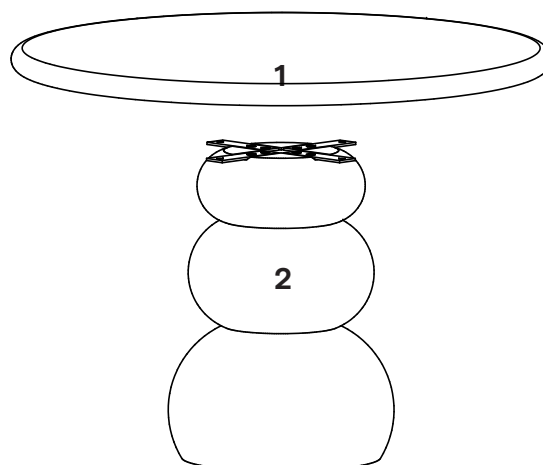

1	Table Top	x1
2	Table Leg	x1

## STEP 01

### HARDWARE

**E** Located Bolt M8 × 50mm x2

### COMPONENTS

**1** Table top x1

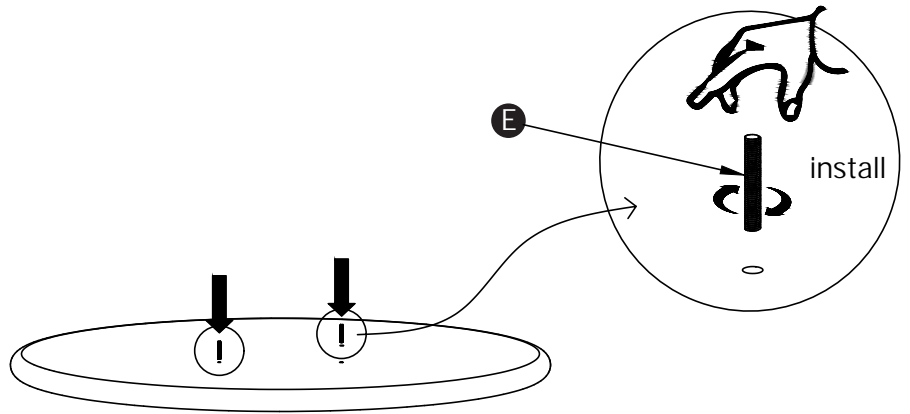

## STEP 02

### COMPONENTS

**1** Table Top x1

**2** Table Leg x1

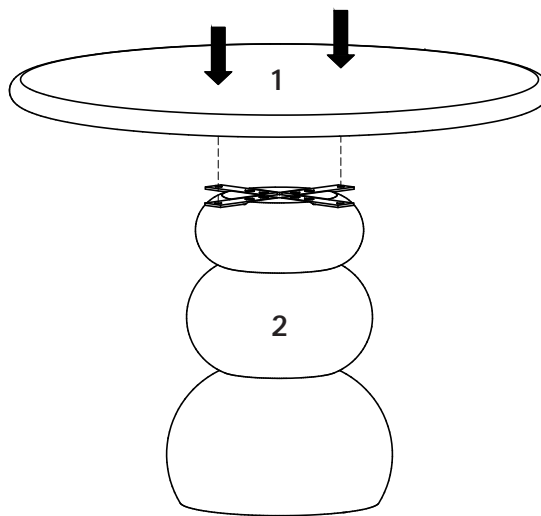

## STEP 03

### HARDWARE

**E** Located Bolts M8 × 50mm x2

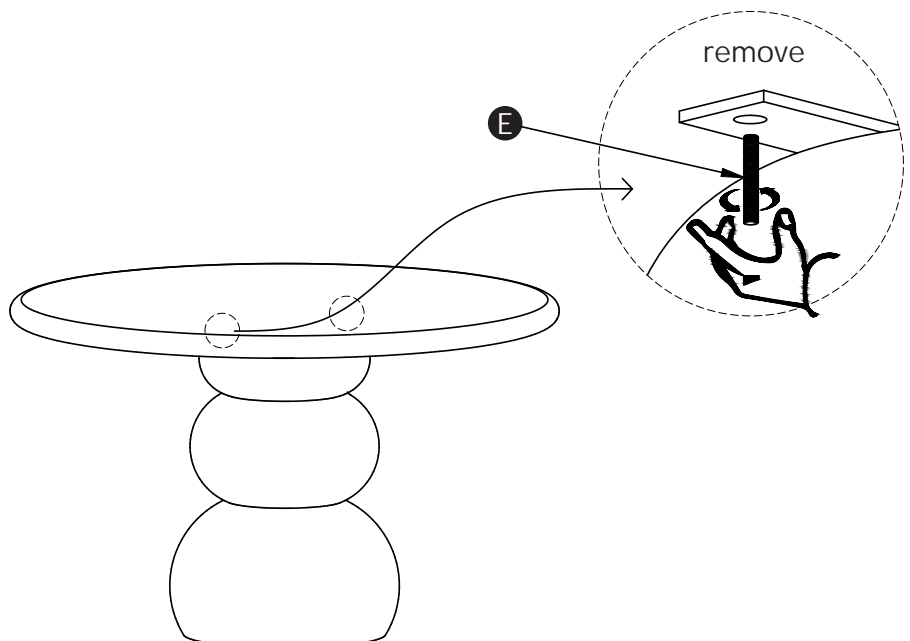

**HARDWARE**

**A** Bolt M8×25mm x4

**B** Spring Washer M8 ø12 x 2mm x4

**C** Washer M8 ø23 x 1mm x4

**TOOLS**

**D** Allen Key x1

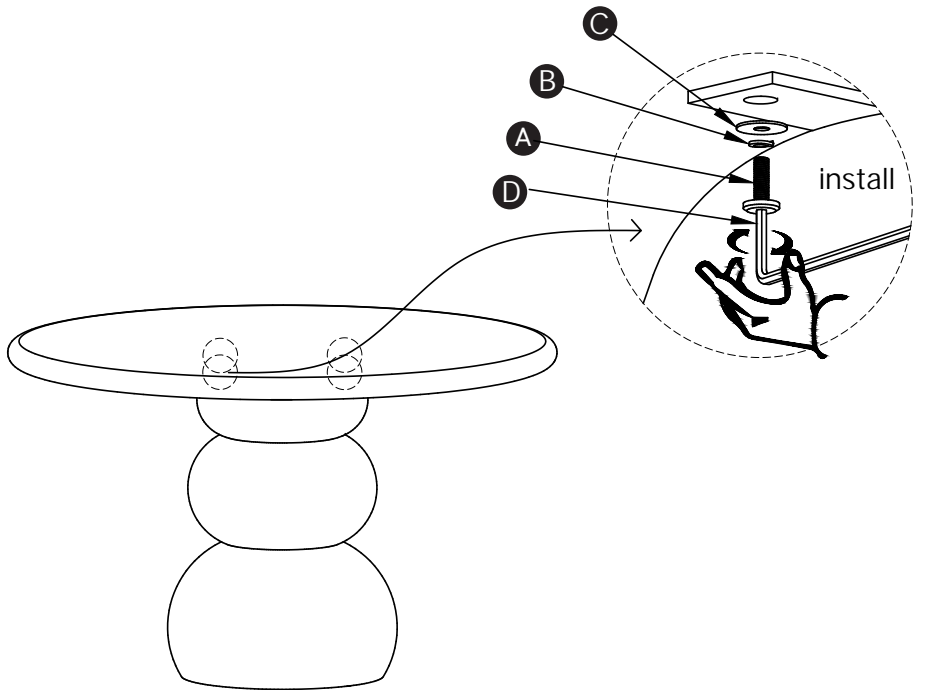

STEP 05

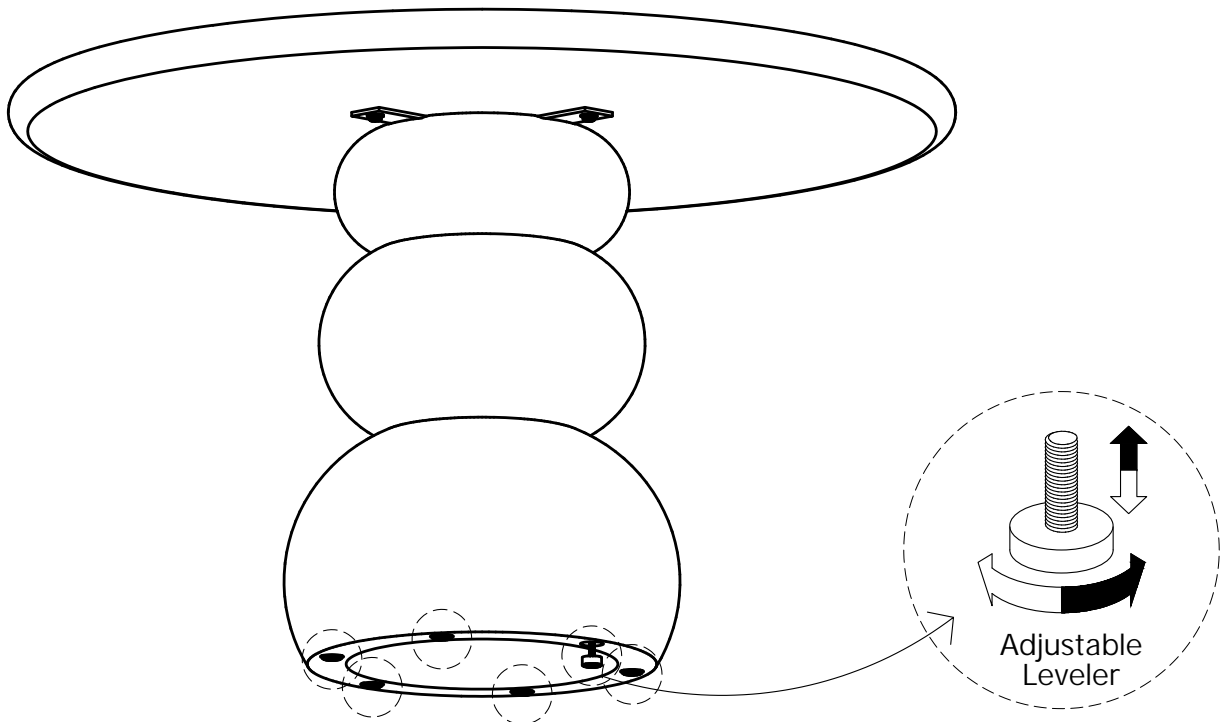

# Great job!

Your new dining table is complete.

---

## CARING FOR YOUR ITEM

- Depending on use, it may be necessary to tighten the hardware from time to time, so please save the tools that have been provided.
- Not contract grade.
- Clean using a non-abrasive cloth and a mild cleaner.

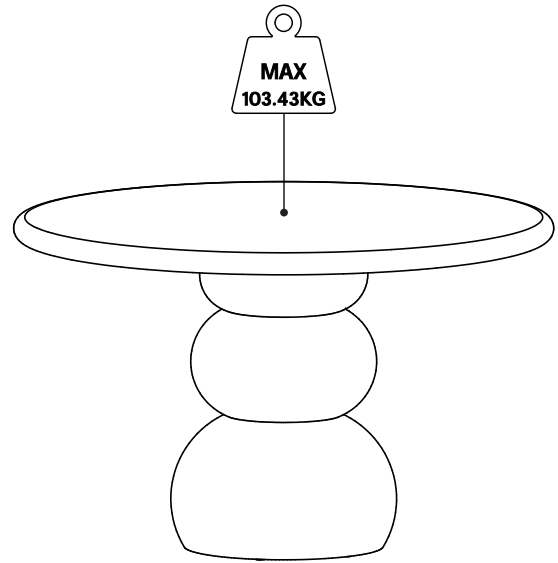

## CONNECT WITH US!

Tag us [@modway\\_furniture](#) and [#modway](#) for a chance to be featured.

# modway



Questions? Contact us!  
609.256.9000  
[cs@modway.com](mailto:cs@modway.com)