

ASSEMBLY INSTRUCTIONS

Right Side Facing Chaise

EEl-7499 / V0.09.09.25

modway



Questions? Contact us!

609.256.9000

cs@modway.com

Welcome.

Let's get started.

Before you begin, here are some things to keep in mind:

Assembly will take most people **about 30 minutes**. Consider having a friend help you!

Only use hand tools to assemble this item. Do not use power tools. Do not tighten bolts or screws completely until all hardware is lined up and inserted into the holes.

Read through all of the instructions before starting. Make sure you have all parts and components before discarding any packing materials.

Do not over-tighten screws and bolts to avoid stripping the hardware or cracking the item.

Assemble your item on a flat, carpeted area, with plenty of space to work. This will prevent damage and scratches to your floors or the item while you're assembling the product.

Keep all components and packaging out of reach of children or animals to avoid risk of choking or suffocation.

Care instructions are listed in the last step of this manual.

FURNITURE COMPONENTS:

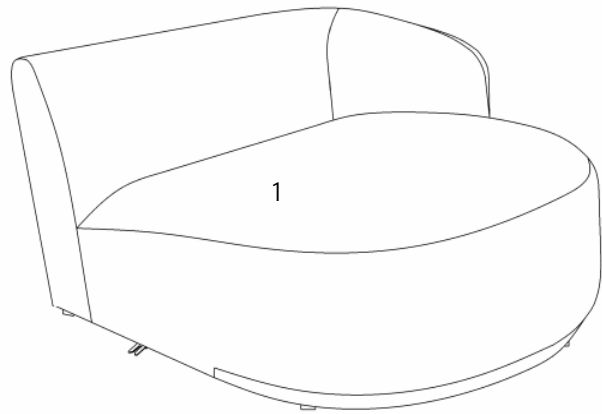

1 Right Side Facing Chaise

x1

WAIT!

Missing parts or hardware? Need assistance?
Contact us before returning your item.
We're here to help!



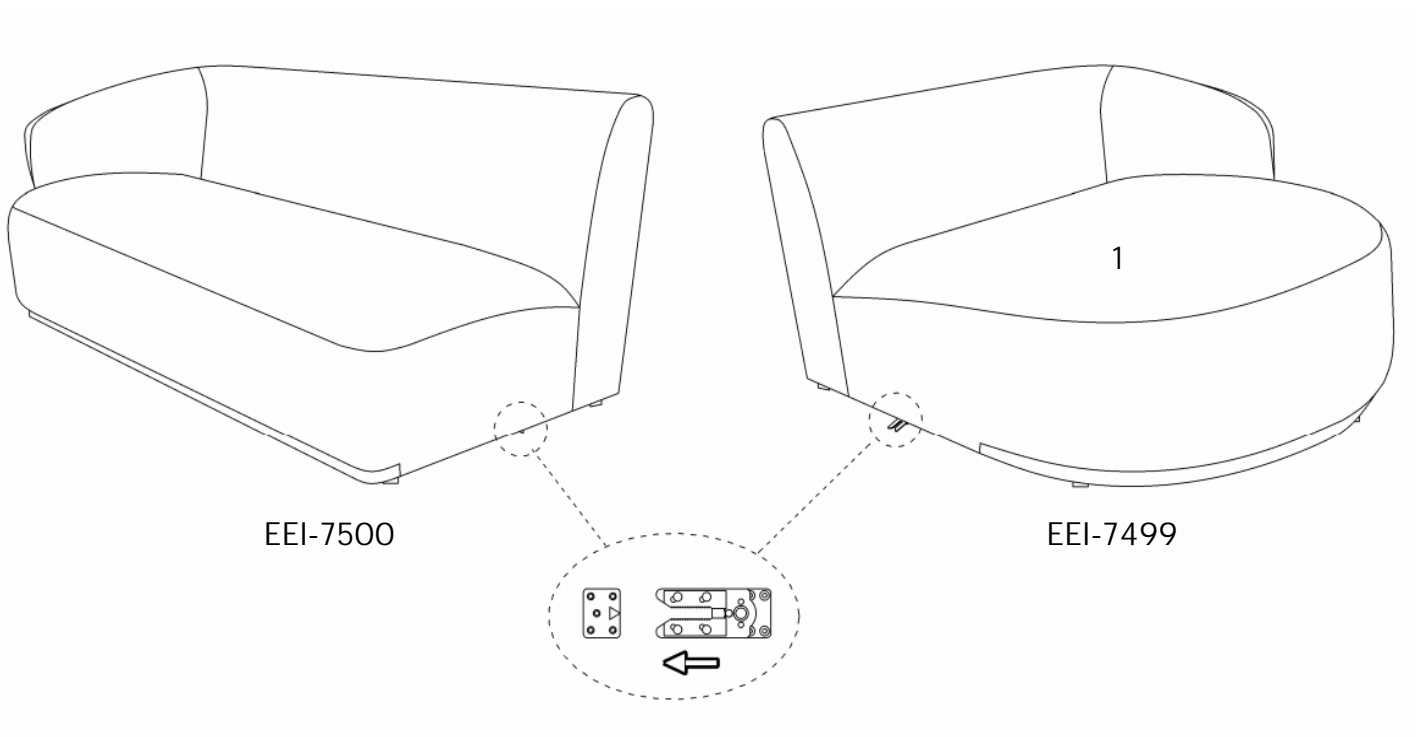

Great job!

Your new sofa is complete.

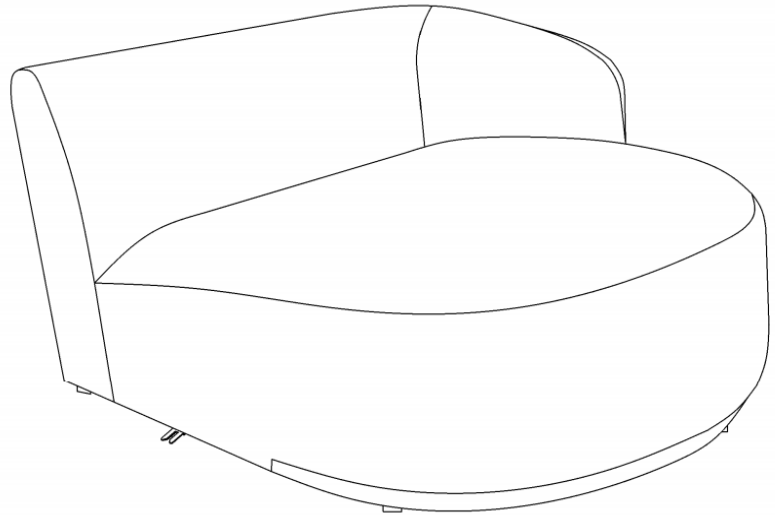

CARING FOR YOUR ITEM

- Indoor use only.
- Not contract grade.
- Clean using a non-abrasive cloth and a mild cleaner.
- Never use harsh chemicals, as they could damage the finish or integrity of the item.



CONNECT WITH US!

Tag us [@modway_furniture](#) and [#modway](#) for a chance to be featured.

modway



Questions? Contact us!
609.256.9000
cs@modway.com

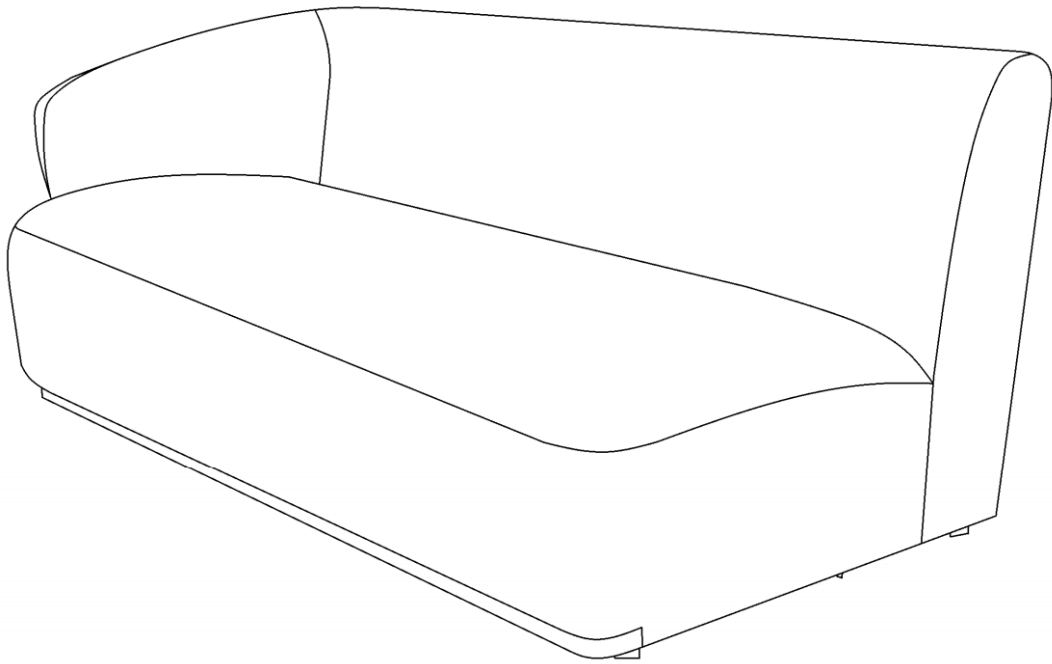

ASSEMBLY INSTRUCTIONS

Left Side Facing Loveseat

EI-7500 / V0.09.09.25

modway



Questions? Contact us!

609.256.9000

cs@modway.com

Welcome.

Let's get started.

Before you begin, here are some things to keep in mind:

Assembly will take most people **about 30 minutes**. Consider having a friend help you!

Only use hand tools to assemble this item. Do not use power tools. Do not tighten bolts or screws completely until all hardware is lined up and inserted into the holes.

Read through all of the instructions before starting. Make sure you have all parts and components before discarding any packing materials.

Do not over-tighten screws and bolts to avoid stripping the hardware or cracking the item.

Assemble your item on a flat, carpeted area, with plenty of space to work. This will prevent damage and scratches to your floors or the item while you're assembling the product.

Keep all components and packaging out of reach of children or animals to avoid risk of choking or suffocation.

Care instructions are listed in the last step of this manual.

FURNITURE COMPONENTS:

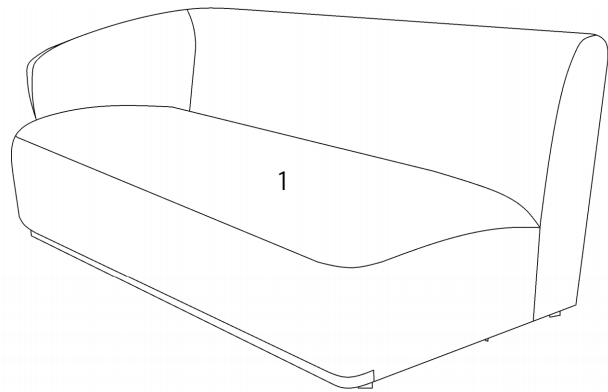

1	Left Side Facing Loveseat	x1
---	---------------------------	----

WAIT!

Missing parts or hardware? Need assistance?
Contact us before returning your item.
We're here to help!



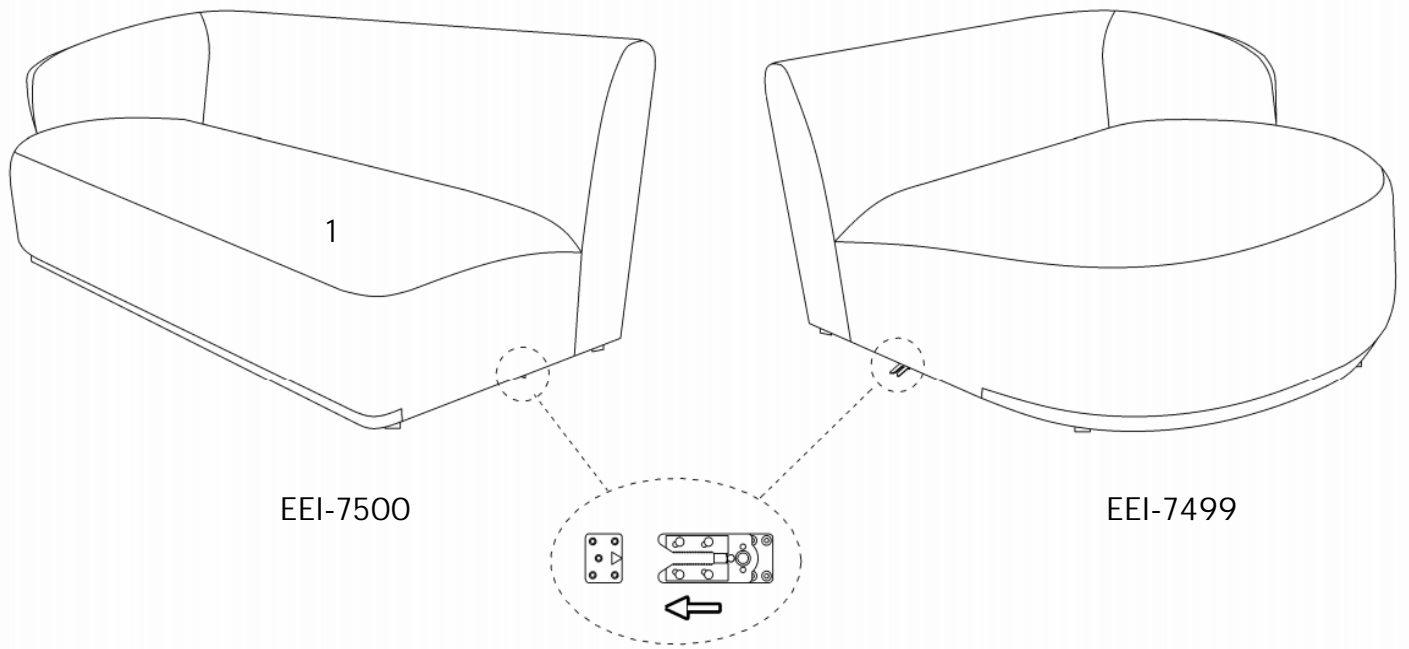

Great job!

Your new sofa is complete.

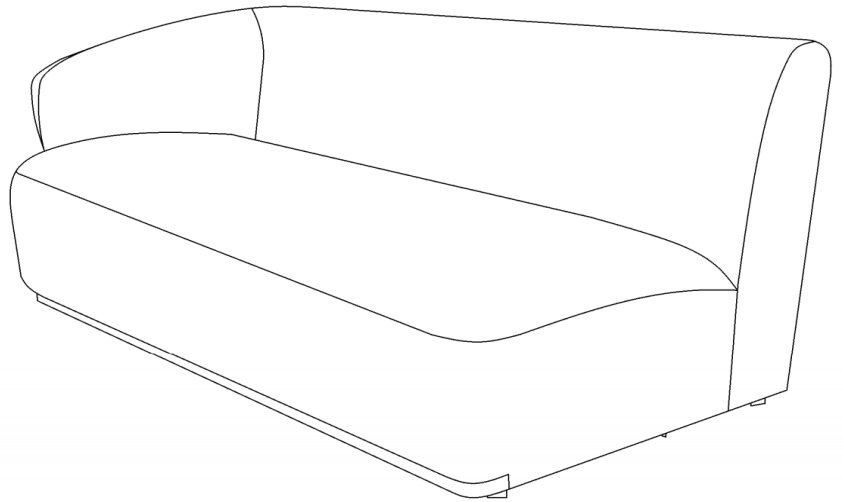

CARING FOR YOUR ITEM

- Indoor use only.
- Not contract grade.
- Clean using a non-abrasive cloth and a mild cleaner.
- Never use harsh chemicals, as they could damage the finish or integrity of the item.



CONNECT WITH US!

Tag us [@modway_furniture](#) and [#modway](#) for a chance to be featured.

modway



Questions? Contact us!
609.256.9000
cs@modway.com