

# ASSEMBLY INSTRUCTIONS

# EEI-7087

V0.07.08.24

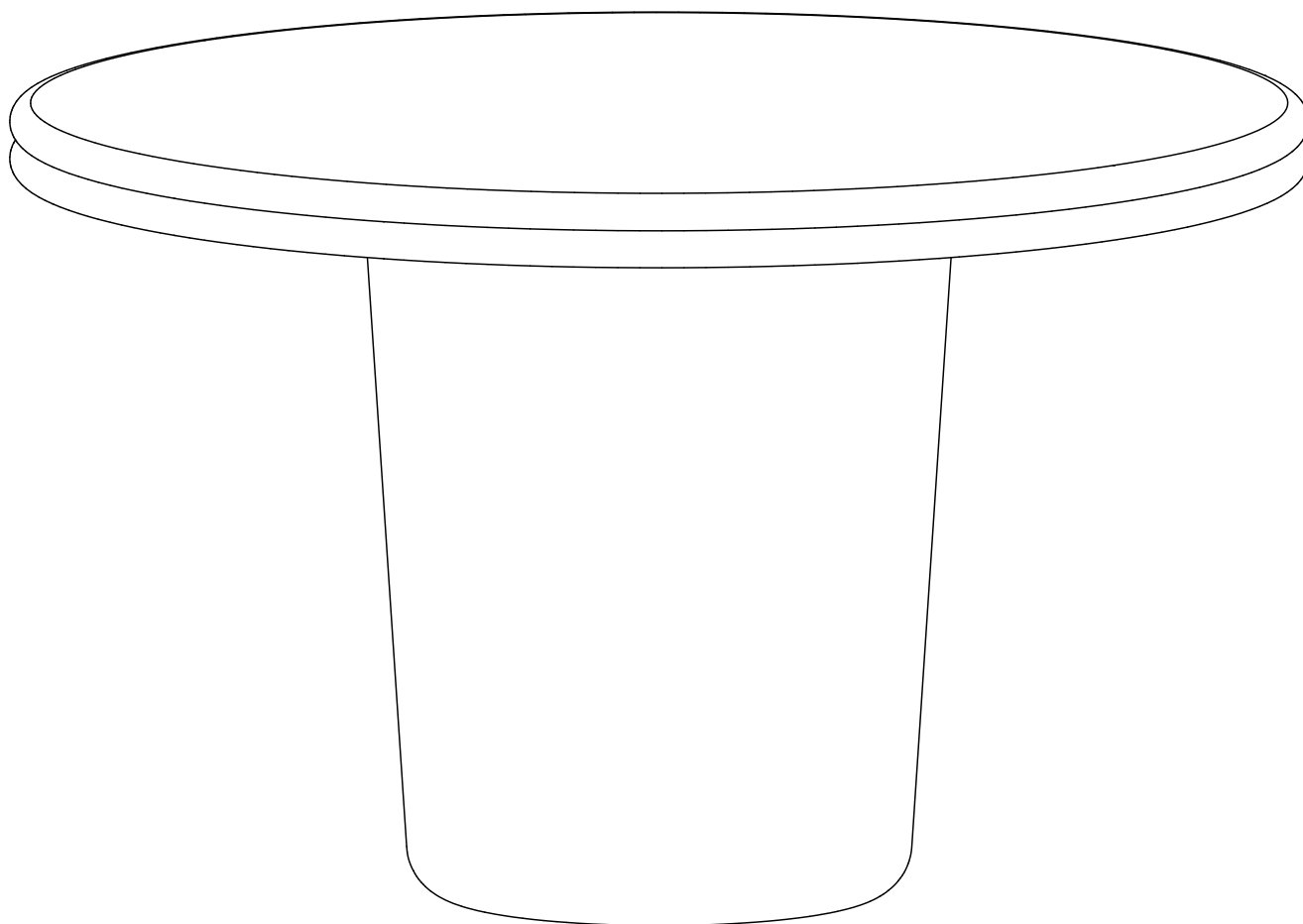

**Questions? Contact us!**

609.256.9000 • [cs@modway.com](mailto:cs@modway.com)  
[www.modway.com](http://www.modway.com)

**\*modway**



Read through all of the instructions before starting



Care instructions are listed in the last step of this manual



Approx. 30 minutes assembly time



Make sure you have all parts and components before discarding any packing materials



2 people recommended for assembly

**Only use hand tools to assemble this item.** Do not use power tools. Do not tighten bolts or screws completely until all hardware is lined up and inserted into the holes.

Do not over-tighten screws and bolts to avoid stripping the hardware or cracking the item.

Assemble your item on a flat, carpeted area, with plenty of space to work. This will prevent damage and scratches to your floors or the item while you're assembling the product.



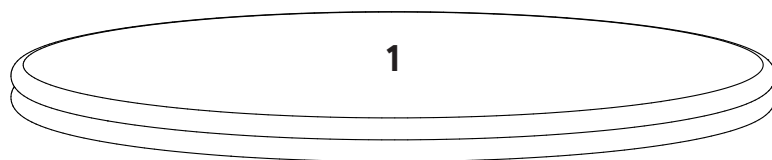

Keep all components and packaging out of reach of children or animals to avoid risk of choking or suffocation.

## Furniture components:

1	Table Top	x1
2	Table Leg	x1

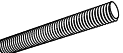

## Provided hardware:

A		Bolt M8 x 25mm	x4
B		Spring Washer M8 ø12 x 2mm	x4
C		Washer M8 ø23 x 1mm	x4
D		Allen Key	x1
E		Located Bolt M8 x 50mm	x2

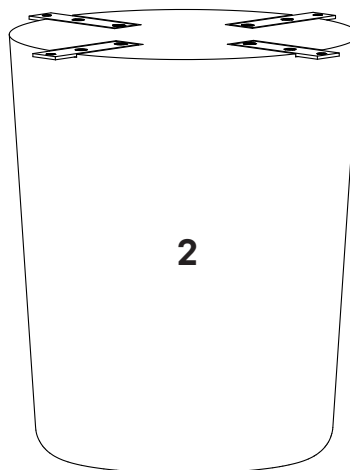

**Wait!**

**Missing parts or hardware? Need assistance?**

Contact us before returning your item. We're here to help!  
609.256.9000 • [cs@modway.com](mailto:cs@modway.com)

# Step 1

## HARDWARE

- E** Connecting Located Bolt M8 x 50mm x2

## COMPONENTS

- 1** Table Top x1

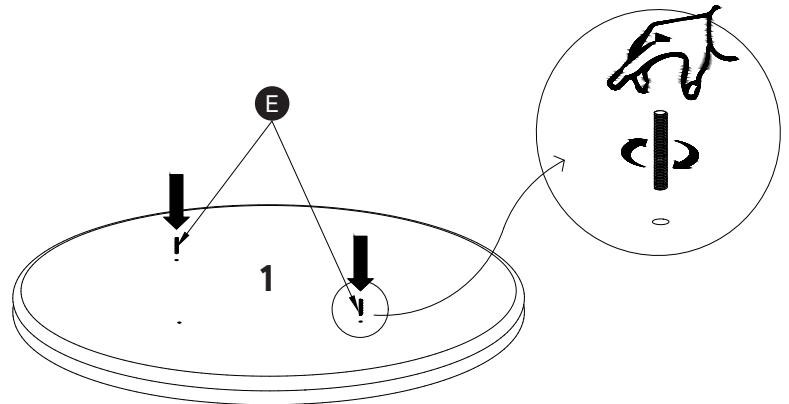

1

# Step 2

## COMPONENTS

- 1** Connecting Table Top x1

- 2** Table Base x1

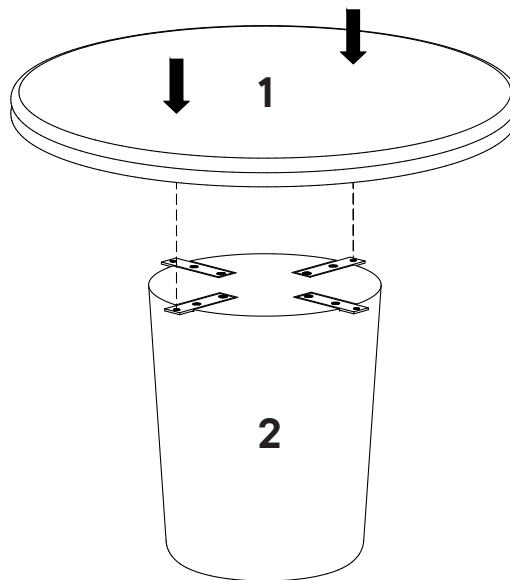

# Step 3

## HARDWARE

- E** Remove Located Bolts M8 x 50mm x2

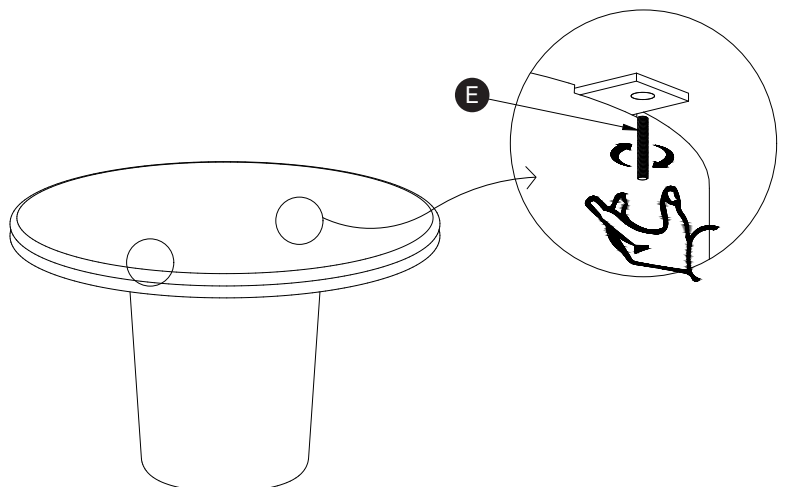

# Step 4

## HARDWARE

- A** Connecting Bolt M8 x 25mm x4
- B** Connecting Spring Washer M8  $\varnothing$ 12 x 2mm x4
- C** Connecting Washer M8  $\varnothing$ 23 x 1mm x4

## TOOLS

- D** Allen Key x1

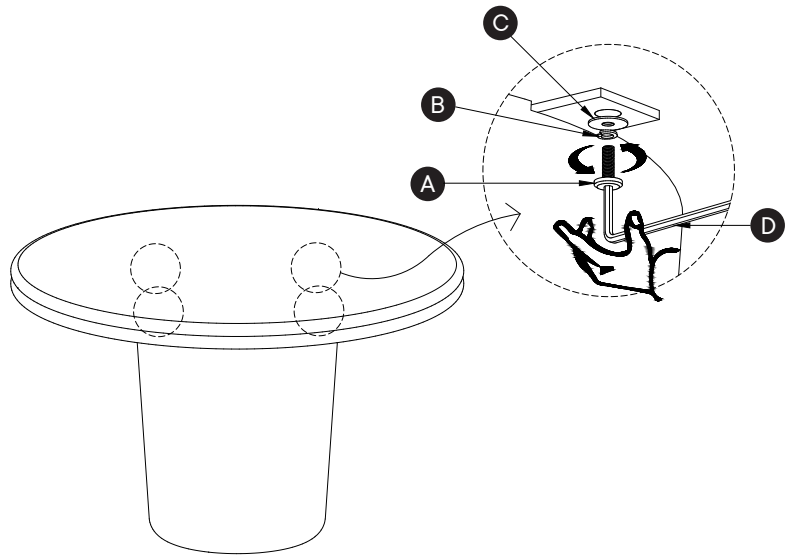

# Step 5

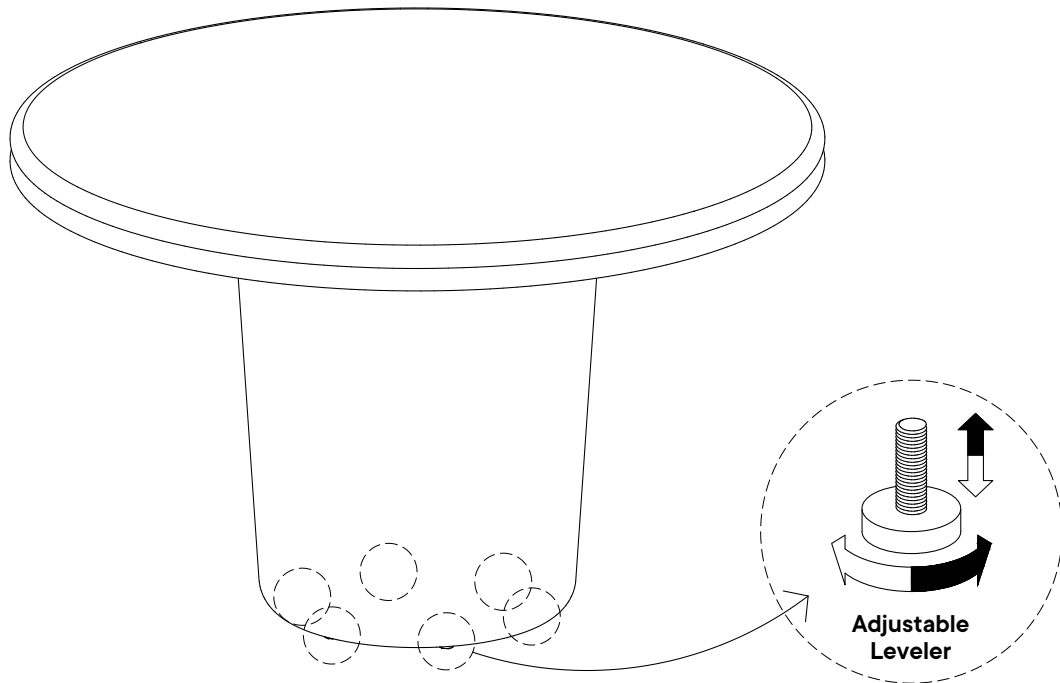

# Great job!

Your new dining table is complete.

## ♥ CARING FOR YOUR ITEM

Depending on use, it may be necessary to tighten the hardware from time to time, so please save the tools that have been provided.

Not contract grade.

Clean using a non-abrasive cloth and a mild cleaner.

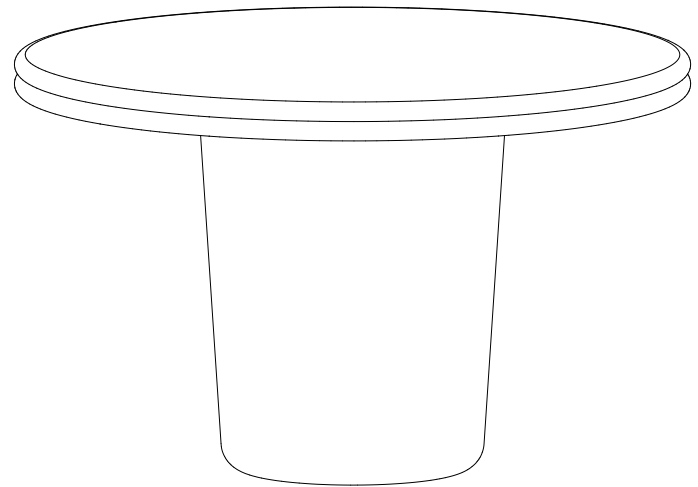

CONNECT WITH US!   

Tag us @modway\_furniture and #modway for a chance to be featured.