

ASSEMBLY INSTRUCTIONS

EEI-6980

V0.20.04.24

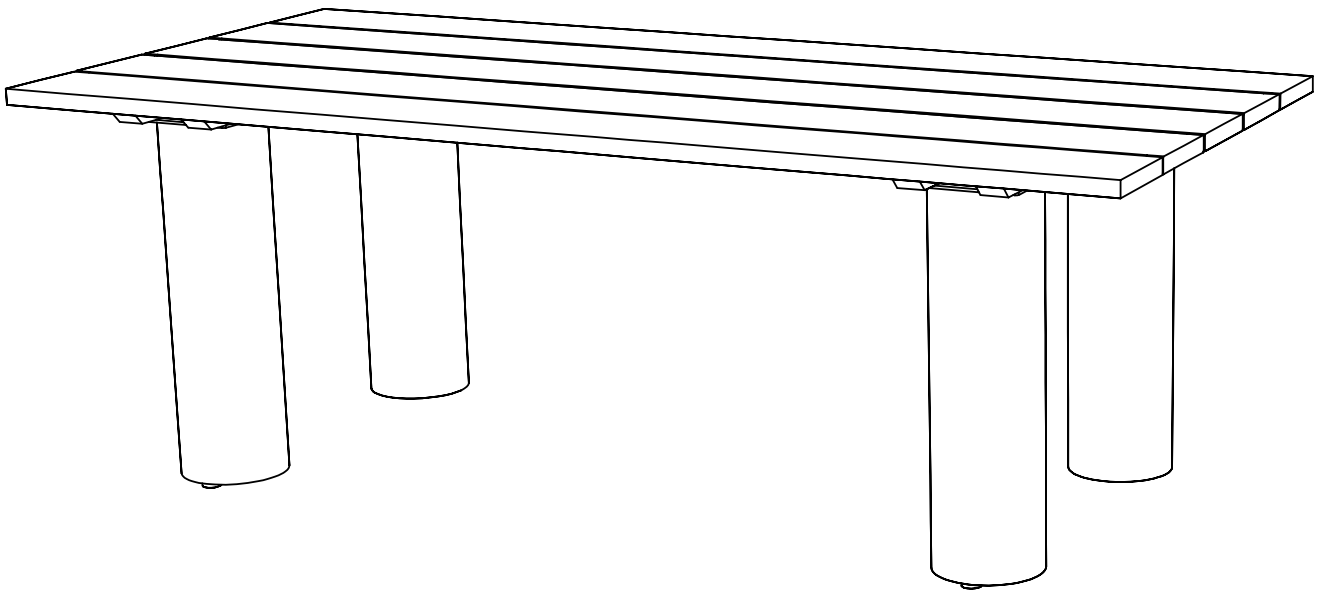

Questions? Contact us!

609.256.9000 • cs@modway.com
www.modway.com

***modway**



Read through all of the instructions before starting



Care instructions are listed in the last step of this manual



Approx. 30 minutes assembly time



Make sure you have all parts and components before discarding any packing materials



1 people recommended for assembly

Only use hand tools to assemble this item. Do not use power tools. Do not tighten bolts or screws completely until all hardware is lined up and inserted into the holes.

Do not over-tighten screws and bolts to avoid stripping the hardware or cracking the item.



Assemble your item on a flat, carpeted area, with plenty of space to work. This will prevent damage and scratches to your floors or the item while you're assembling the product.

Keep all components and packaging out of reach of children or animals to avoid risk of choking or suffocation.

Furniture components:

1	Table Top	x1
2	Table Leg	x4

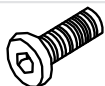
Provided hardware:

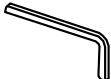
A		Cam Bolt M6 x 20mm	x16
B		Flat Washer M6	x16
C		Allen Key	x1

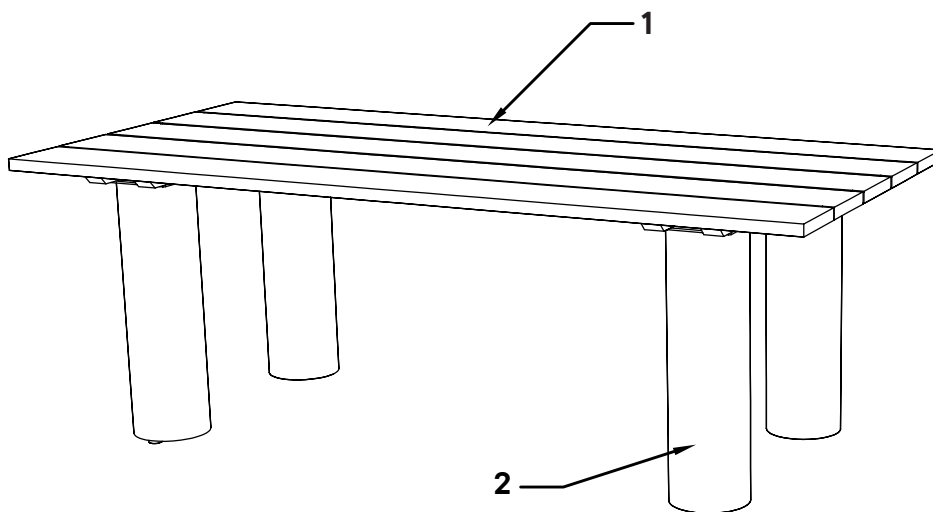

Note : Hardware packed in the leg carton.

Wait!

Missing parts or hardware? Need assistance?
Contact us before returning your item. We're here to help!
609.256.9000 • cs@modway.com

Step 1

COMPONENTS

- 1 Table Top x1
- 2 Table Leg x4

HARDWARE

- A Cam Bolt M6 x 20mm x16
- B Flat Washer M6 x16
- C Allen Key x1

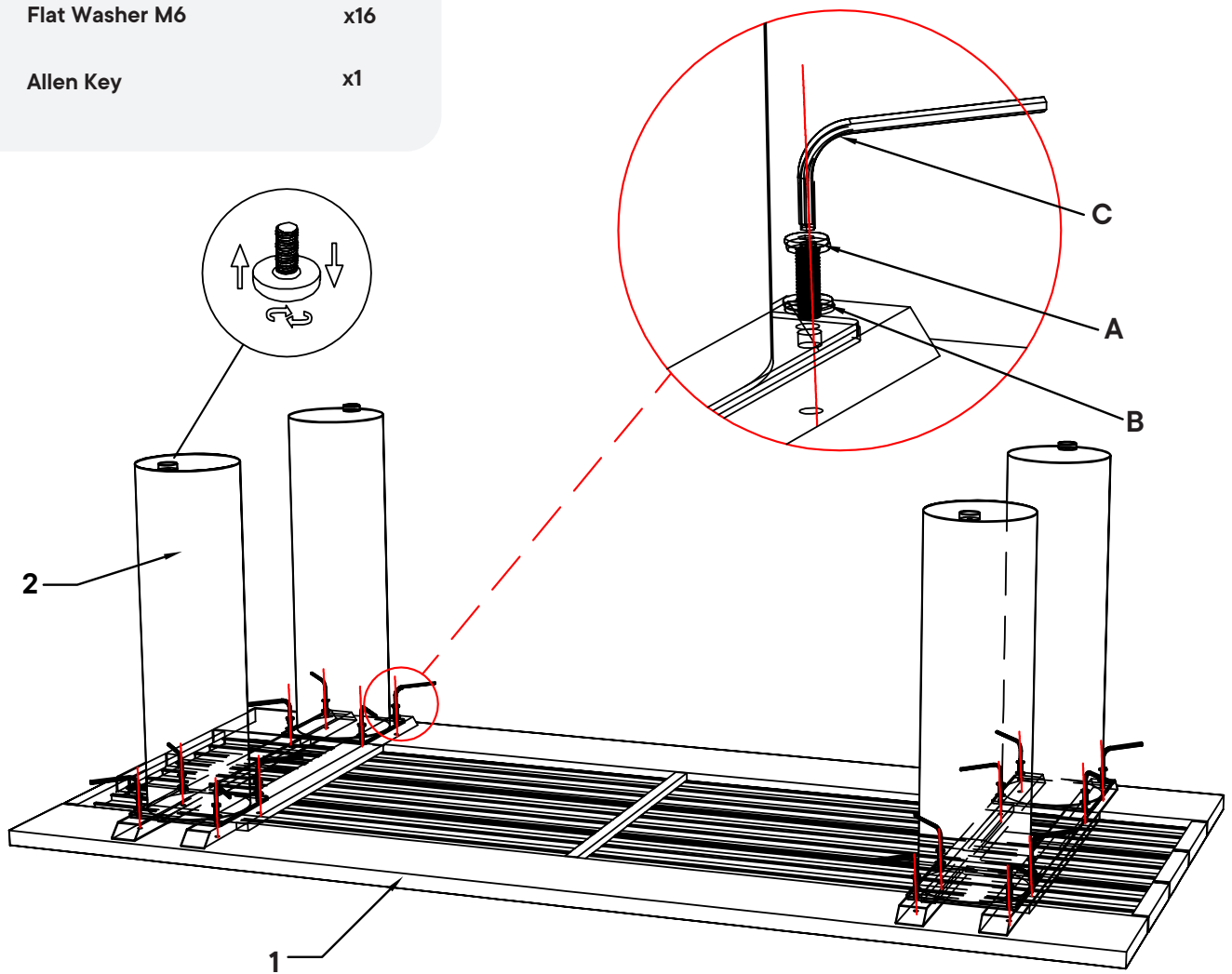

Great job!

Your new table is complete.

♥ CARING FOR YOUR ITEM

Indoor and outdoor use.

Not contract grade.

Spot clean using a non-abrasive cloth and a mild cleaner.

Never use harsh chemicals, as they could damage the finish or integrity of the item.

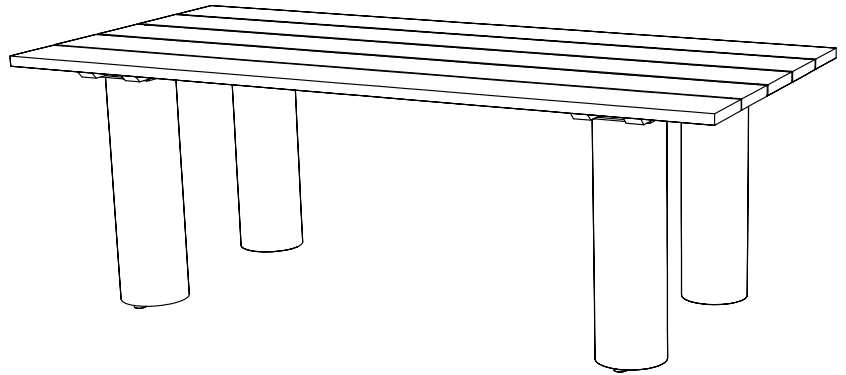

CONNECT WITH US!   

Tag us [@modway_furniture](#) and [#modway](#) for a chance to be featured.