

ASSEMBLY INSTRUCTIONS

EEI-6886/6887

V1.04.03.24

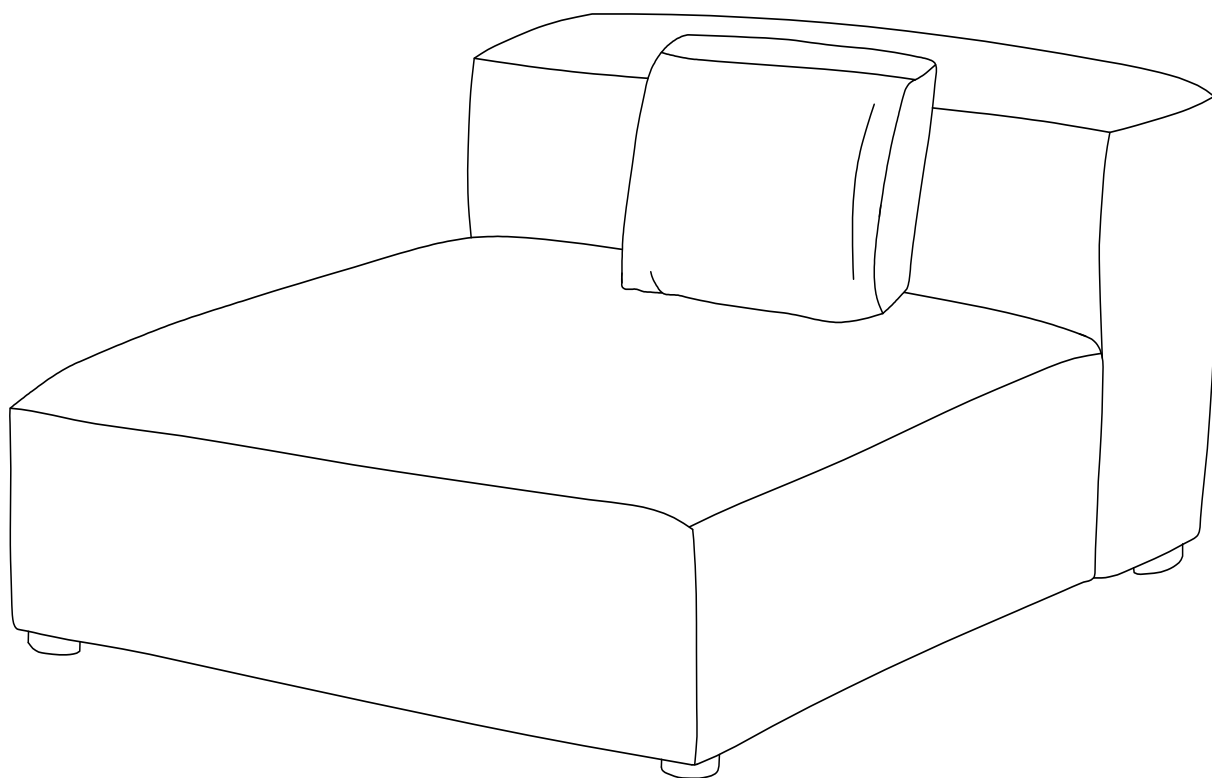

Questions? Contact us!

609.256.9000 • cs@modway.com
www.modway.com

***modway**



Read through all of the instructions before starting



Care instructions are listed in the last step of this manual



Approx. 30 minutes assembly time



Make sure you have all parts and components before discarding any packing materials



2 people recommended for assembly

Only use hand tools to assemble this item. Do not use power tools. Do not tighten bolts or screws completely until all hardware is lined up and inserted into the holes.

Do not over-tighten screws and bolts to avoid stripping the hardware or cracking the item.

Assemble your item on a flat, carpeted area, with plenty of space to work. This will prevent damage and scratches to your floors or the item while you're assembling the product.



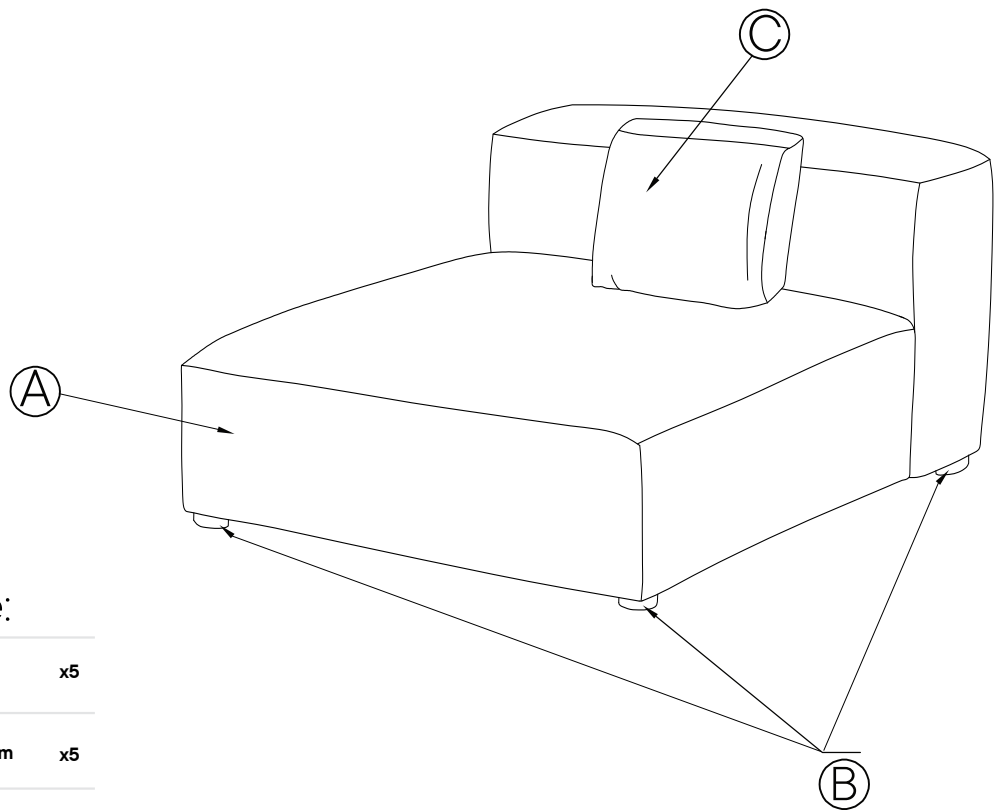

Keep all components and packaging out of reach of children or animals to avoid risk of choking or suffocation.

Furniture components:

A	Frame Body	x1
B	Leg	x5
C	Back Cushion	x1



Provided hardware:

D		Bolt 1/4 x 60mm	x5
E		Flat Washer 1/4x19mm	x5
F		Allen Wrench	x1
G		Felt Pad	x5

Wait!

Missing parts or hardware? Need assistance?
Contact us before returning your item. We're here to help!
609.256.9000 • cs@modway.com

Step 1

COMPONENTS

A	Frame Body	x1
B	Leg	x5
C	Back Cushion	x1

HARDWARE

D	Bolt 1/4 x 60mm	x5
E	Flat Washer 1/4x19mm	x5
F	Allen Wrench	x1
G	Felt Pad	x5

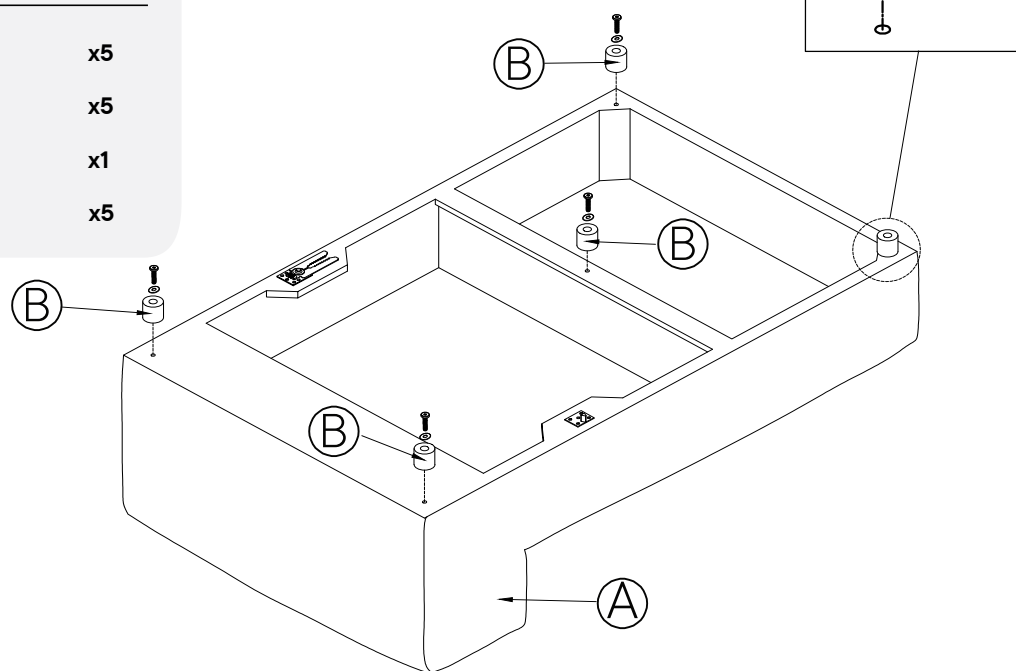

Step 2

COMPONENTS

C	Back cushion = 1 pc
----------	---------------------

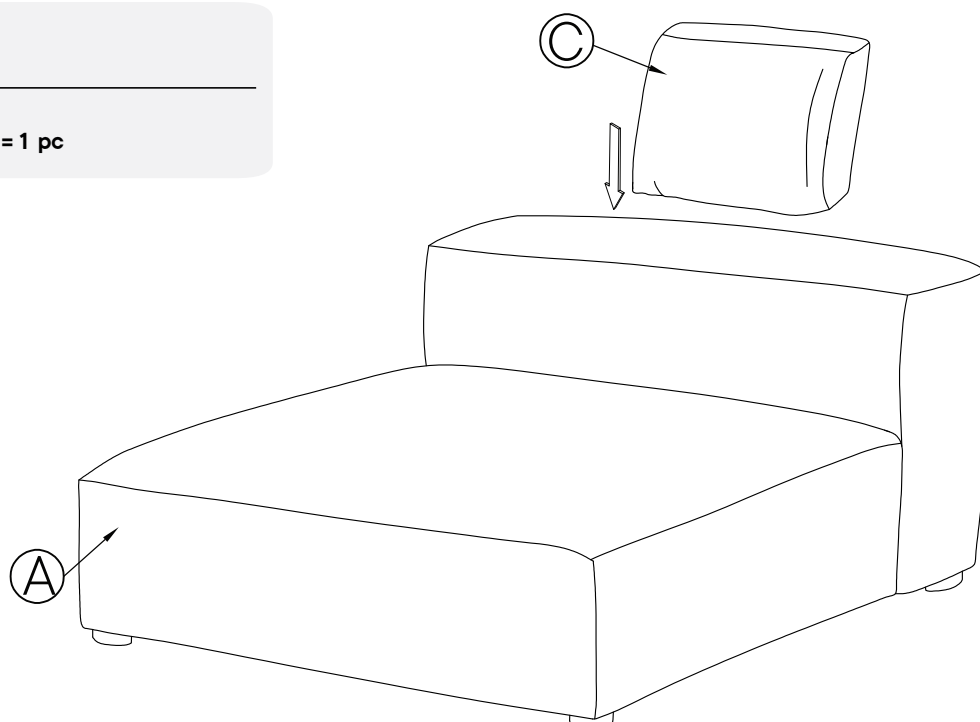

Great job!

Your corner is complete and ready to enjoy.

♥ CARING FOR YOUR ITEM

Indoor use.

Not contract grade.

Clean using a non-abrasive cloth and a mild cleaner.

Never use harsh chemicals, as they could damage the finish or integrity of the item.

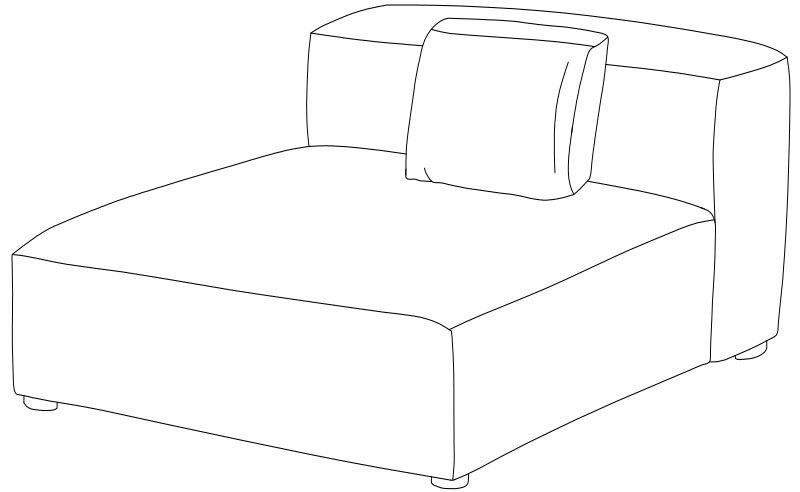

CONNECT WITH US!   

Tag us @modway_furniture and #modway for a chance to be featured.