

ASSEMBLY INSTRUCTIONS

EEI-3385

V1.09.01.23

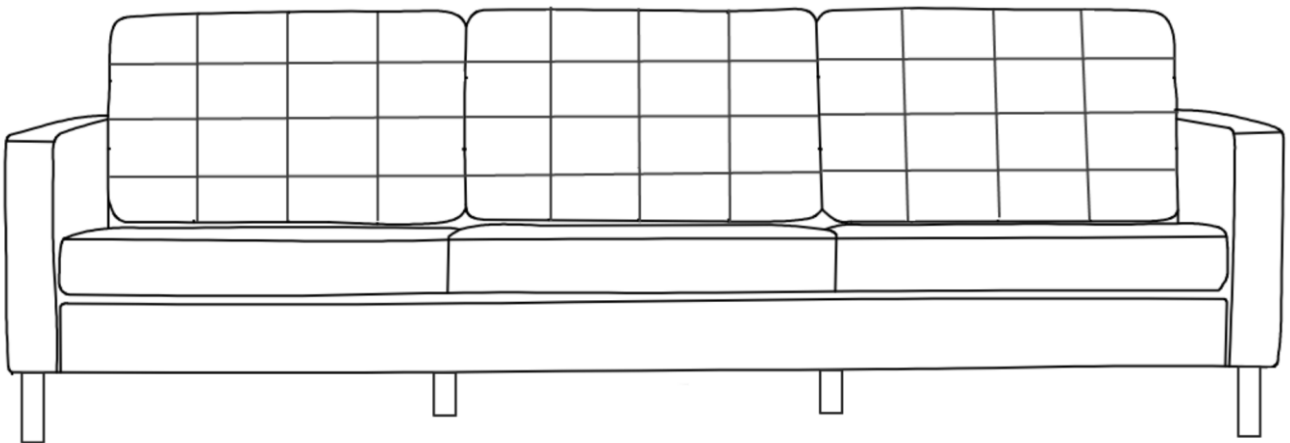

Questions? Contact us!

609.256.9000 • cs@modway.com
www.modway.com

*modway

Let's get started!

*modway



Read through all of the instructions before starting



Care instructions are listed in the last step of this manual



Approx. 30 minutes assembly time



Make sure you have all parts and components before discarding any packing materials



2 people recommended for assembly

Only use hand tools to assemble this item. Do not use power tools. Do not tighten bolts or screws completely until all hardware is lined up and inserted into the holes.

Do not over-tighten screws and bolts to avoid stripping the hardware or cracking the item.

Assemble your item on a flat, carpeted area, with plenty of space to work. This will prevent damage and scratches to your floors or the item while you're assembling the product.

Keep all components and packaging out of reach of children or animals to avoid risk of choking or suffocation.

Furniture components:

1	Sofa Base	x1
2	Back Cushion	x3
3	Metal Leg	x4
4	Middle Leg	x2

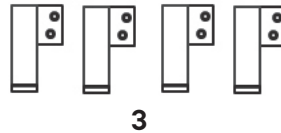
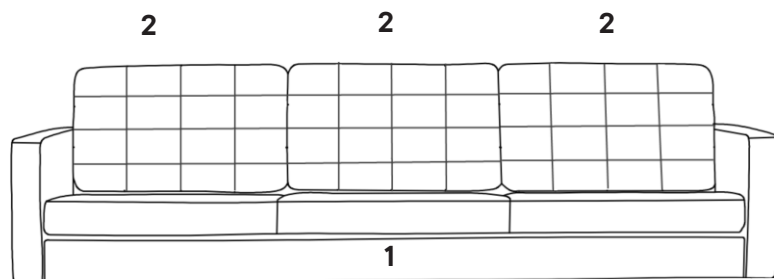

Provided hardware:

A		Bolt M8 x 35mm	x12
B		Flat Washer M8	x12
C		Allen Wrench M8	x1

Wait!

Missing parts or hardware? Need assistance?
Contact us before returning your item. We're here to help!
609.256.9000 • cs@modway.com

Step 1

COMPONENTS

1	Sofa Base	x1
3	Metal Leg	x4
4	Middle Leg	x2

HARDWARE

A	Bolt M8 x 35mm	x12
B	Flat Washer M8	x12
C	Allen Wrench M8	x1

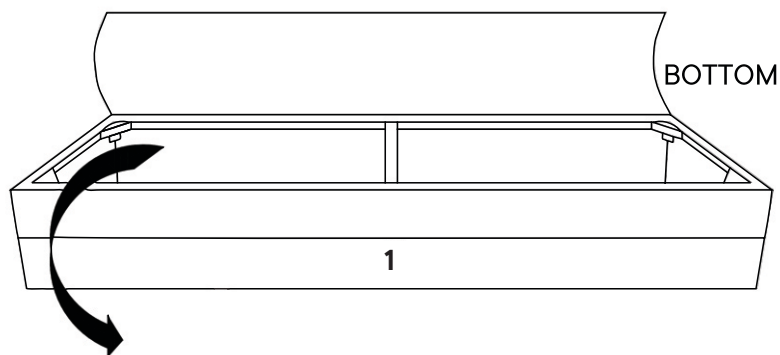

Unzip the bottom cover and locate the Metal Leg (3) + Middle Leg (4) + Hardware package.

Step 2

COMPONENTS

1	Sofa Base	x1
3	Metal Leg	x4
4	Middle Leg	x2

HARDWARE

A	Bolt M8 x 65mm	x12
B	Flat Washer M8	x12
C	Allen Wrench M8	x1

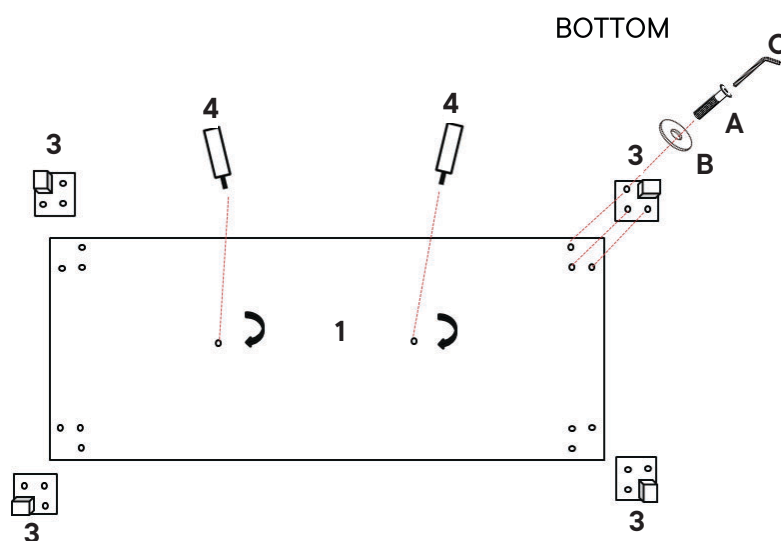

Step 3

COMPONENTS

2 Back Cushion x3

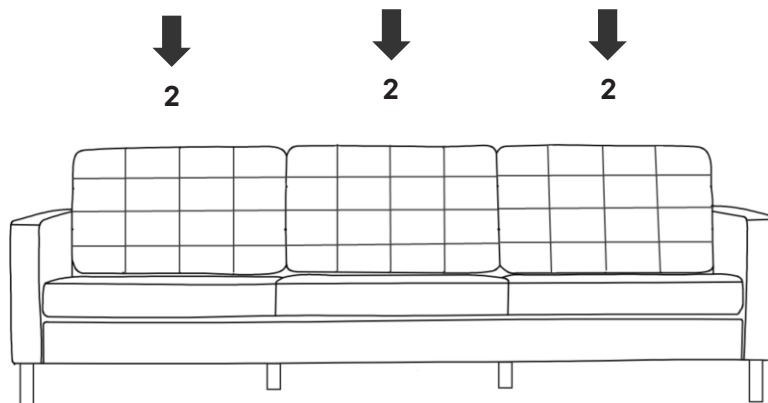

Great job!

Your sofa is complete and ready to enjoy.

♥ CARING FOR YOUR ITEM

Indoor use only.

Not contract grade.

Clean using a non-abrasive cloth and a mild cleaner.

Never use harsh chemicals, as they could damage the finish or integrity of the item.

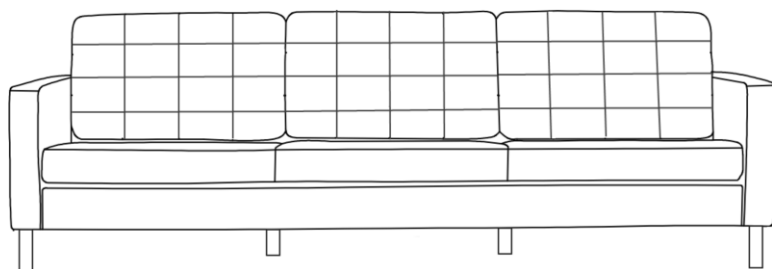

CONNECT WITH US!   

Tag us @modway_furniture and #modway for a chance to be featured.

ASSEMBLY INSTRUCTIONS

EEI-3394

V1.09.01.23

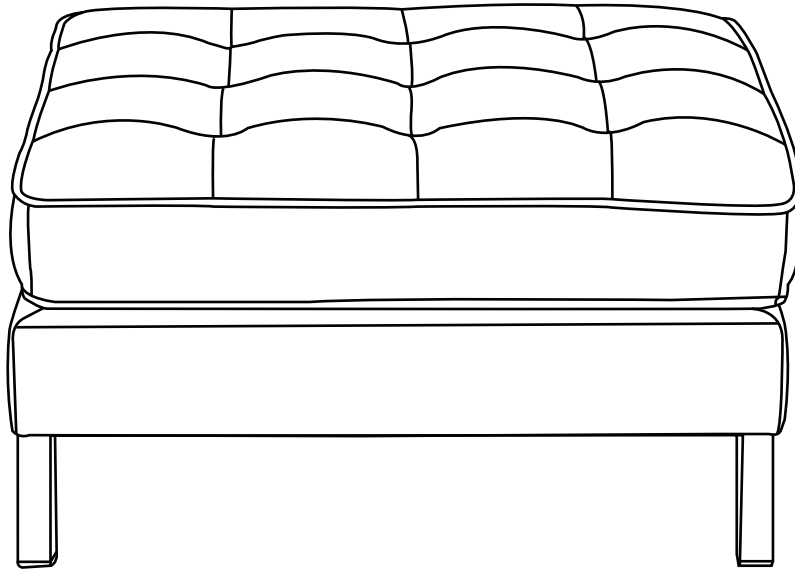

Questions? Contact us!

609.256.9000 • cs@modway.com
www.modway.com

*modway



Read through all of the instructions before starting



Care instructions are listed in the last step of this manual



Approx. 30 minutes assembly time



Make sure you have all parts and components before discarding any packing materials



2 people recommended for assembly

Only use hand tools to assemble this item. Do not use power tools. Do not tighten bolts or screws completely until all hardware is lined up and inserted into the holes.

Do not over-tighten screws and bolts to avoid stripping the hardware or cracking the item.

Assemble your item on a flat, carpeted area, with plenty of space to work. This will prevent damage and scratches to your floors or the item while you're assembling the product.



Keep all components and packaging out of reach of children or animals to avoid risk of choking or suffocation.

Furniture components:

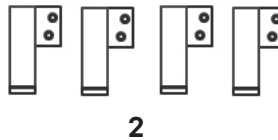
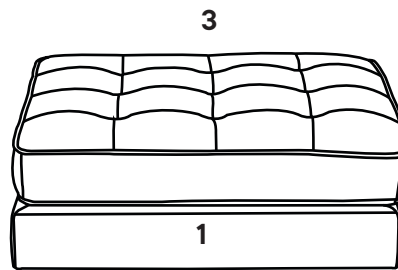
1	Ottoman Base	x1
2	Metal Leg	x4
3	Ottoman Cushion	x1



Provided hardware:

A		Bolt M8 x 35mm	x12
B		Flat Washer M8	x12
C		Allen Wrench M8	x1

Wait!

Missing parts or hardware? Need assistance?
Contact us before returning your item. We're here to help!
609.256.9000 • cs@modway.com

Step 1

COMPONENTS

- 1 Ottoman Base x1
- 2 Metal Leg x4

HARDWARE

- A Bolt M8 x 35mm x12
- B Flat Washer M8 x12
- C Allen Wrench M8 x1

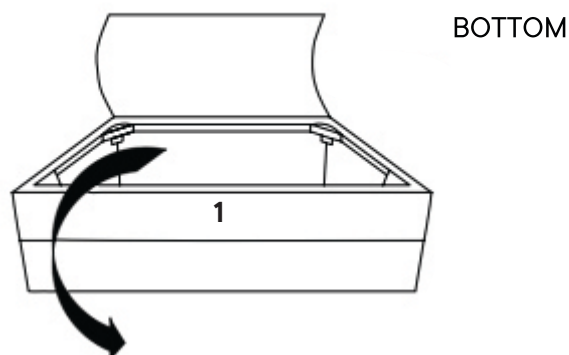

Unzip the bottom cover and locate the Metal Leg (2) + Hardware package.

Step 2

COMPONENTS

- 1 Ottoman Base x1
- 2 Metal Leg x4

HARDWARE

- A Bolt M8 x 65mm x12
- B Flat Washer M8 x12
- C Allen Wrench M8 x1

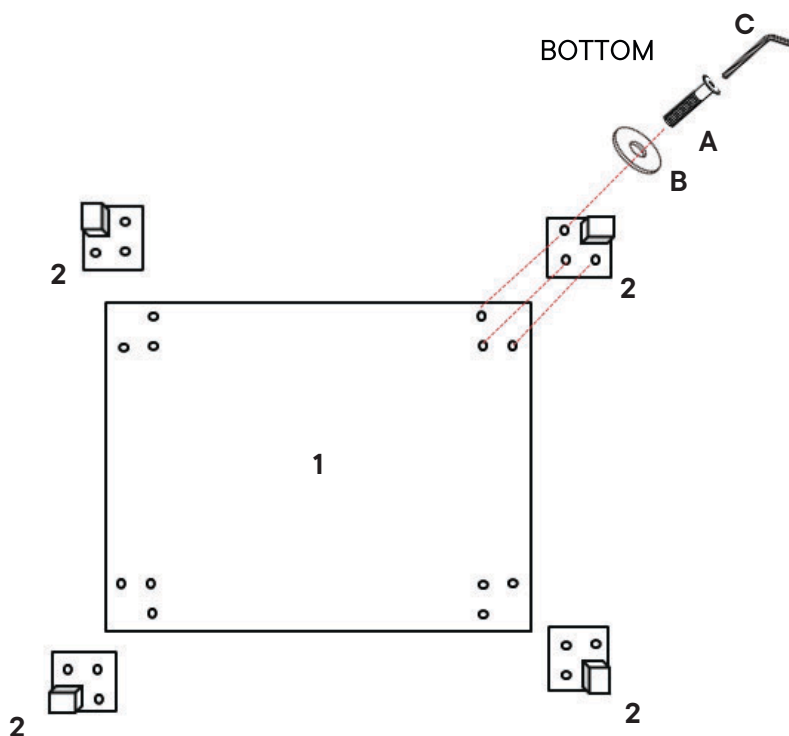

Step 3

COMPONENTS

3 Ottoman Cushion x1

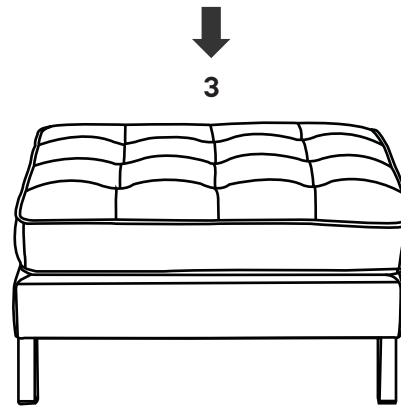

Great job!

Your ottoman is complete and ready to enjoy.

♥ CARING FOR YOUR ITEM

Indoor use only.

Not contract grade.

Clean using a non-abrasive cloth and a mild cleaner.

Never use harsh chemicals, as they could damage the finish or integrity of the item.

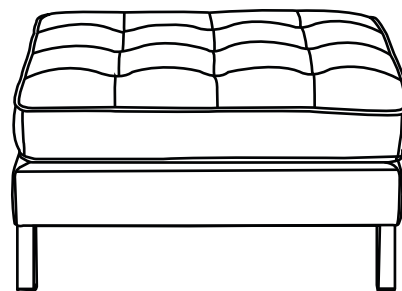

CONNECT WITH US!   

Tag us @modway_furniture and #modway for a chance to be featured.