

ASSEMBLY INSTRUCTIONS

EEI-6262

V1.24.02.23

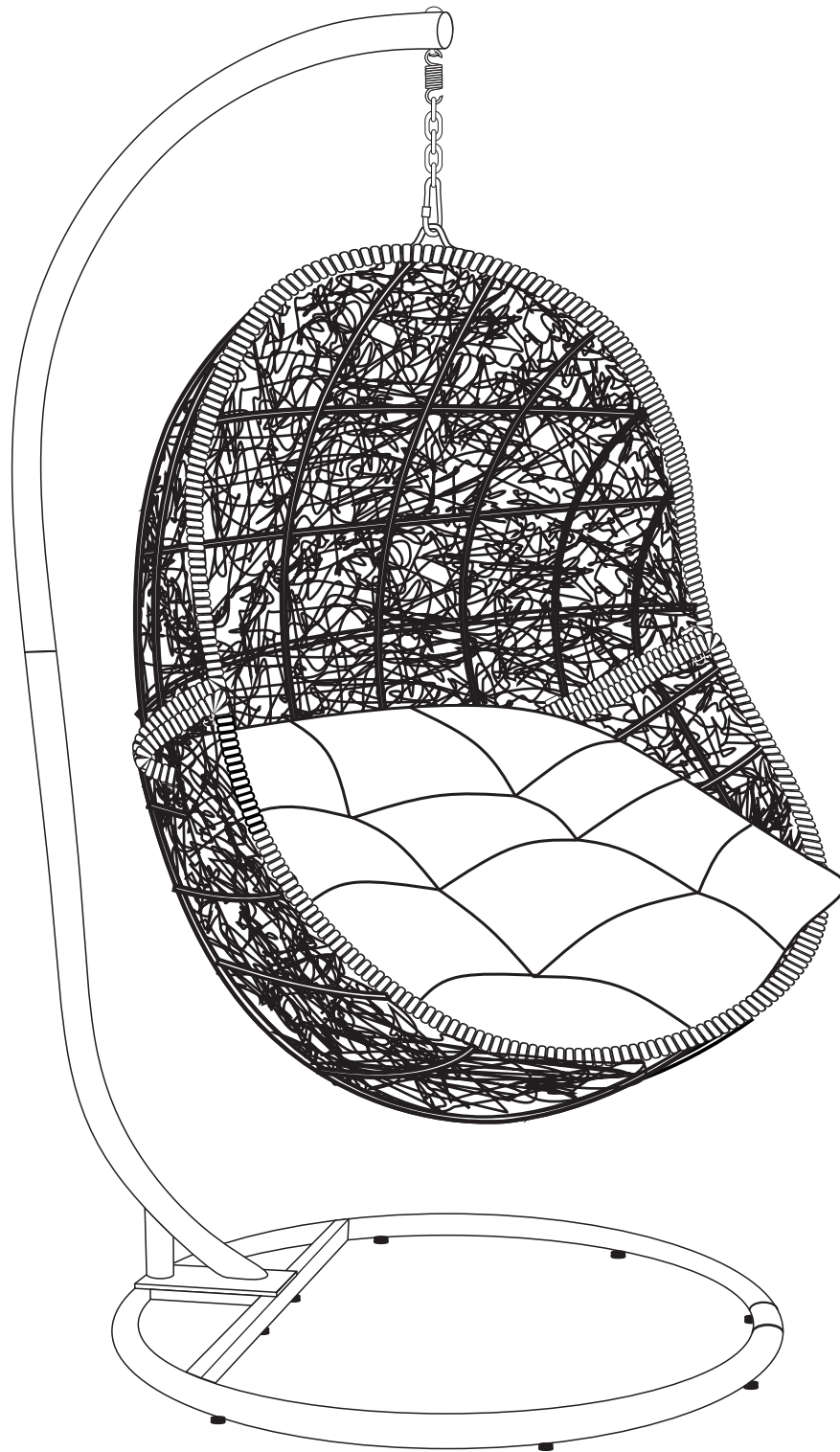

Questions? Contact us!

609.256.9000 • cs@modway.com
www.modway.com

*modway

Let's get started!

*modway



Read through all of the instructions before starting



Approx. 30 minutes assembly time



2 people recommended for assembly



Care instructions are listed in the last step of this manual



Make sure you have all parts and components before discarding any packing materials

Only use hand tools to assemble this item. Do not use power tools. Do not tighten bolts or screws completely until all hardware is lined up and inserted into the holes.

Do not over-tighten screws and bolts to avoid stripping the hardware or cracking the item.

Assemble your item on a flat, carpeted area, with plenty of space to work. This will prevent damage and scratches to your floors or the item while you're assembling the product.

Keep all components and packaging out of reach of children or animals to avoid risk of choking or suffocation.

Furniture components:

1	Left Base	x1
2	Right Base	x1
3	Lower Stand	x1
4	Upper Stand	x1
5	Basket Frame	x1
6	Cushion	x1

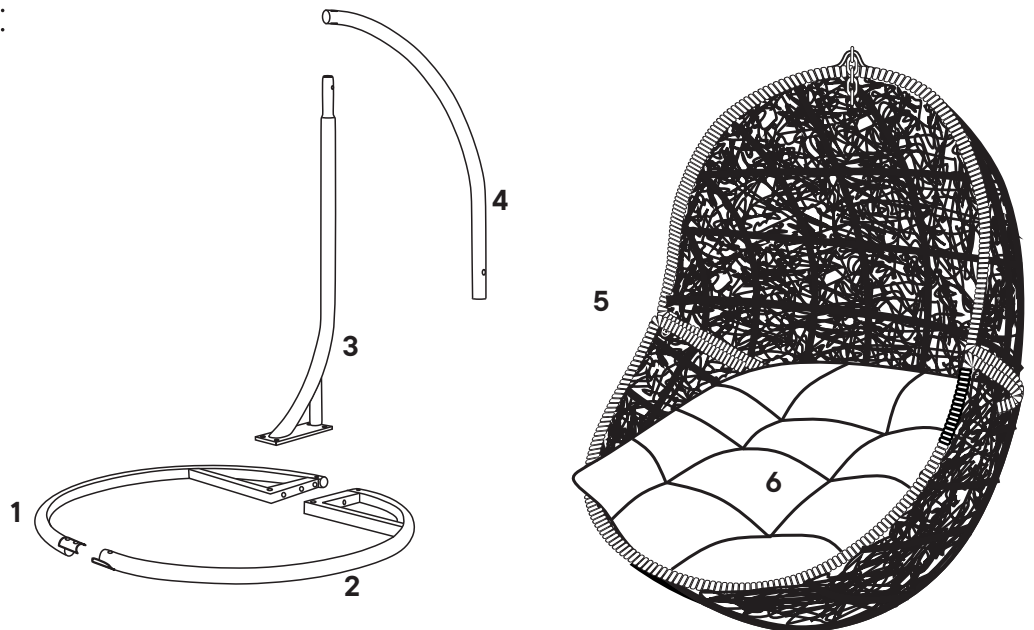

Provided hardware:

B		Bolt/Nut M10x55mm	x1	L		Screw + Washer + Screw Cap	x4
C		Bolt/Nut M10x60mm	x4	M		Open Wrench 10mm	x1
D		Bolt/Nut M10x20mm	x3	N		Allen Wrench 4x4mm	x1
E		Leveller	x10				
F		Screw Set M6x30mm	x2				
G		Spring	x1				
H		Spring Pin	x1				
J		Allen Wrench 8x8mm	x1				
K		Open Wrench 17mm	x1				

What you need:

Philips Head Screwdriver

Wait!

Missing parts or hardware? Need assistance?
Contact us before returning your item. We're here to help!
609.256.9000 • cs@modway.com

Step 1

COMPONENTS

- ① Left Base x1
- ② Right Base x1

HARDWARE

- ⓓ Bolt/Nut M10x20mm x3
- ⓔ Leveller x10
- ⓕ Screw Set M6x30mm x2
- ⓙ Allen Wrench 8x8mm x1
- Ⓚ Open Wrench 17mm x1

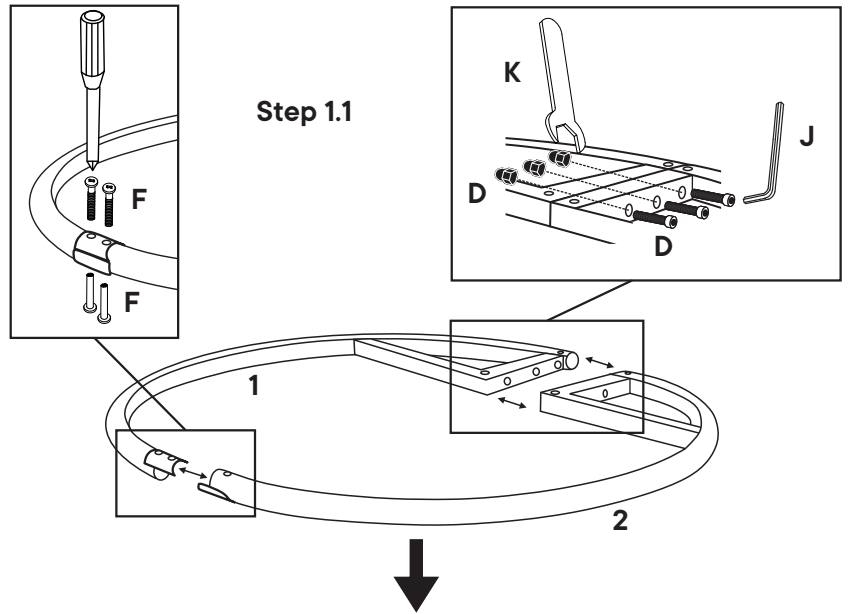

Step 1.2

Bottom View

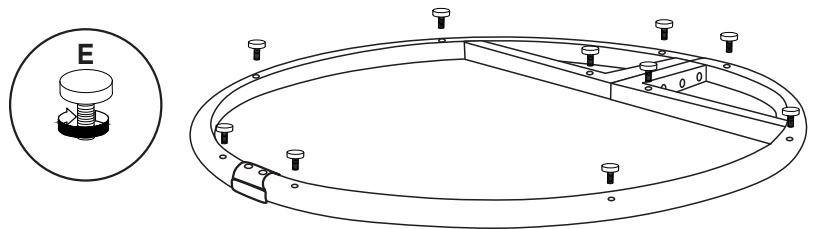

Step 2

COMPONENTS

- ① Left Base x1
- ② Right Base x1
- ③ Lower Stand x1
- ④ Upper Stand x1

HARDWARE

- ⓑ Bolt/Nut M10x55mm x1
- ⓒ Bolt/Nut M10x60mm x4
- ⓖ Spring x1
- ⓗ Spring Pin x1
- ⓙ Allen Wrench 8x8mm x1
- Ⓚ Open Wrench 17mm x1

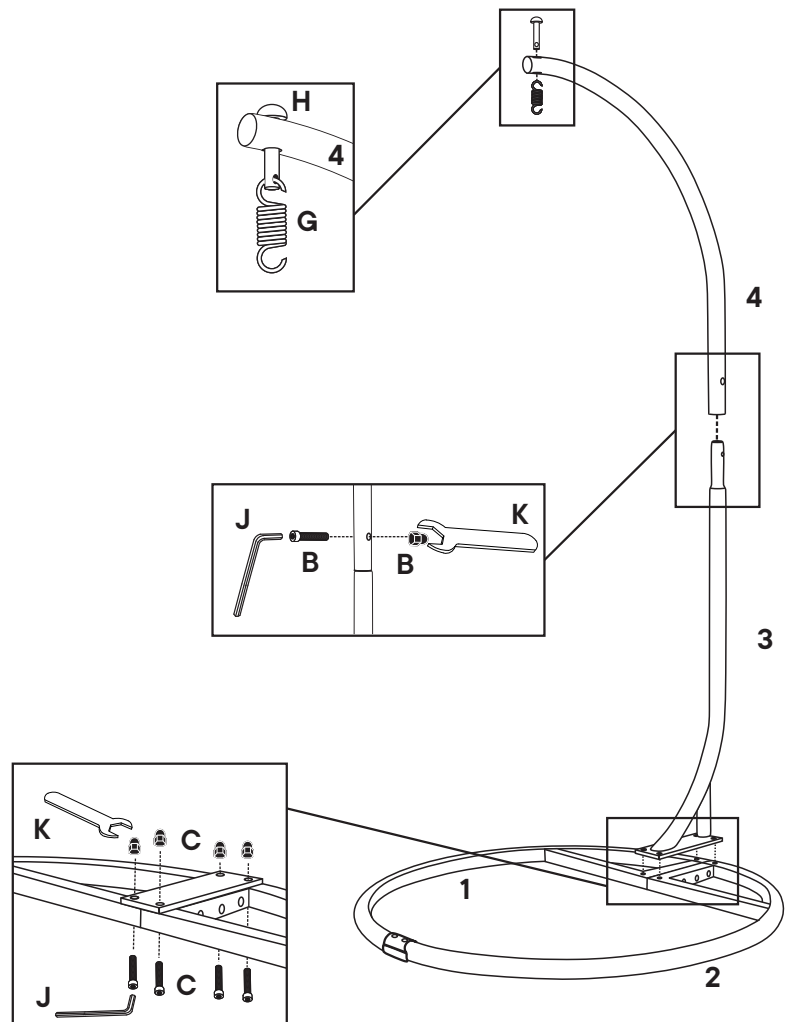

Step 3

COMPONENTS

5 Basket Frame x1

HARDWARE

L Screw + Washer + Screw Cap x4

M Open Wrench 10mm x1

N Allen Wrench 4x4mm x1

Notes: Do not fully tighten until all bolts are assembled.

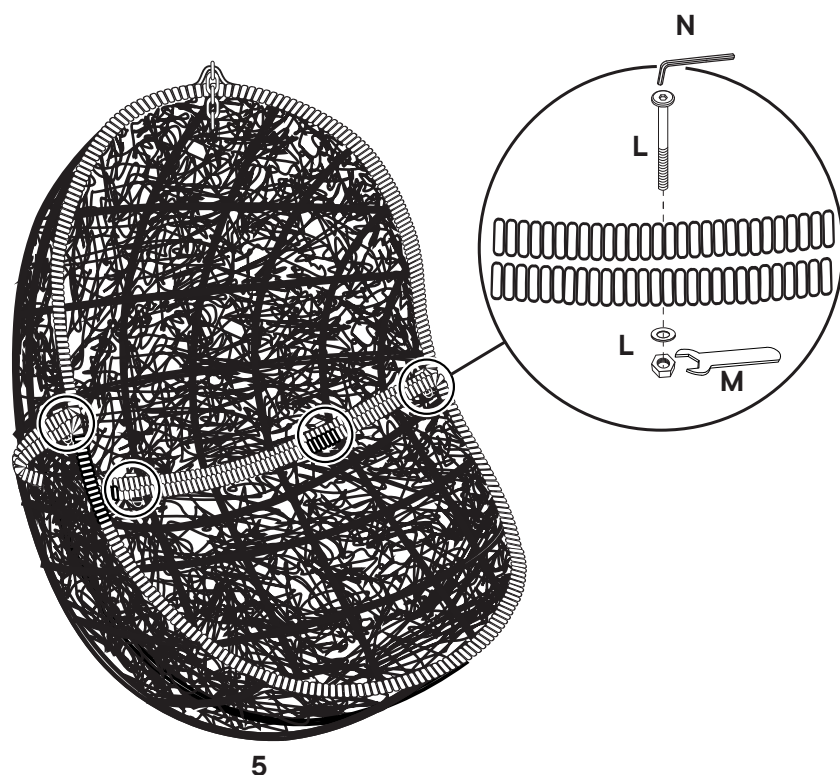

Step 4

COMPONENTS

4 Upper Stand x1

5 Basket Frame x1

6 Cushion x1

HARDWARE

G Spring x1

H Spring Pin x1

All the leveller can be adjusted as required, Please adjust the leveller once the product is not leveled.

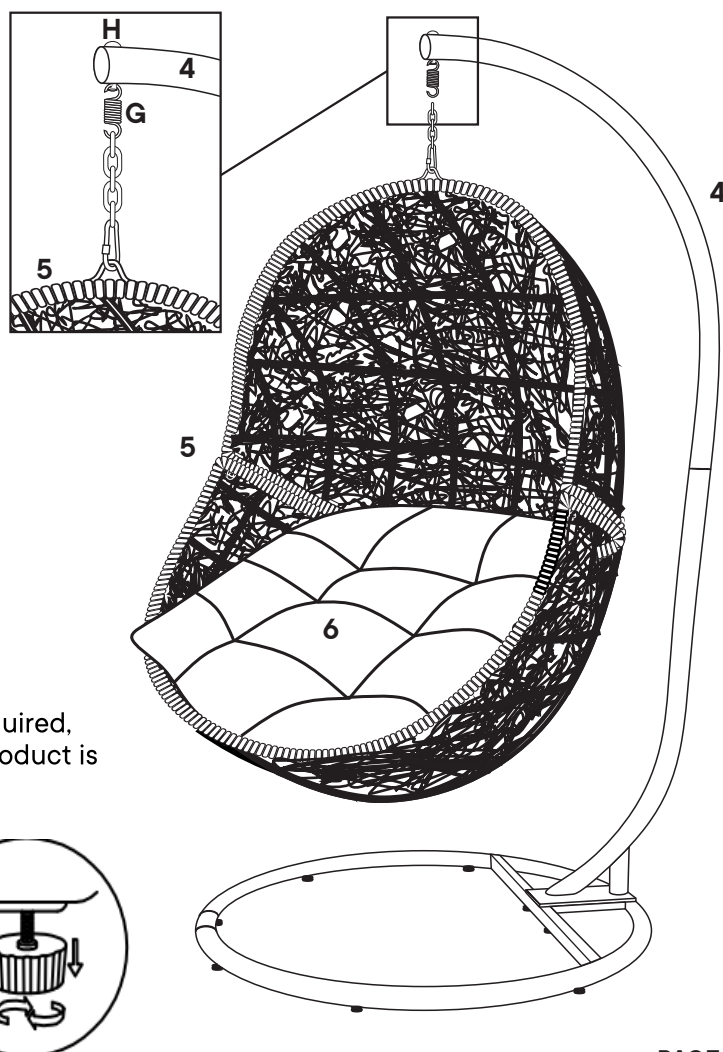

Great job!

Your swing chair is complete and ready to enjoy.

♥ CARING FOR YOUR ITEM

Indoor use only.

Not contract grade.

Clean using a non-abrasive cloth and a mild cleaner.

Never use harsh chemicals, as they could damage the finish or integrity of the item.

CONNECT WITH US!   

Tag us @modway_furniture and #modway for a chance to be featured.

