

ASSEMBLY INSTRUCTIONS

EEI-5746

V1.21.03.21

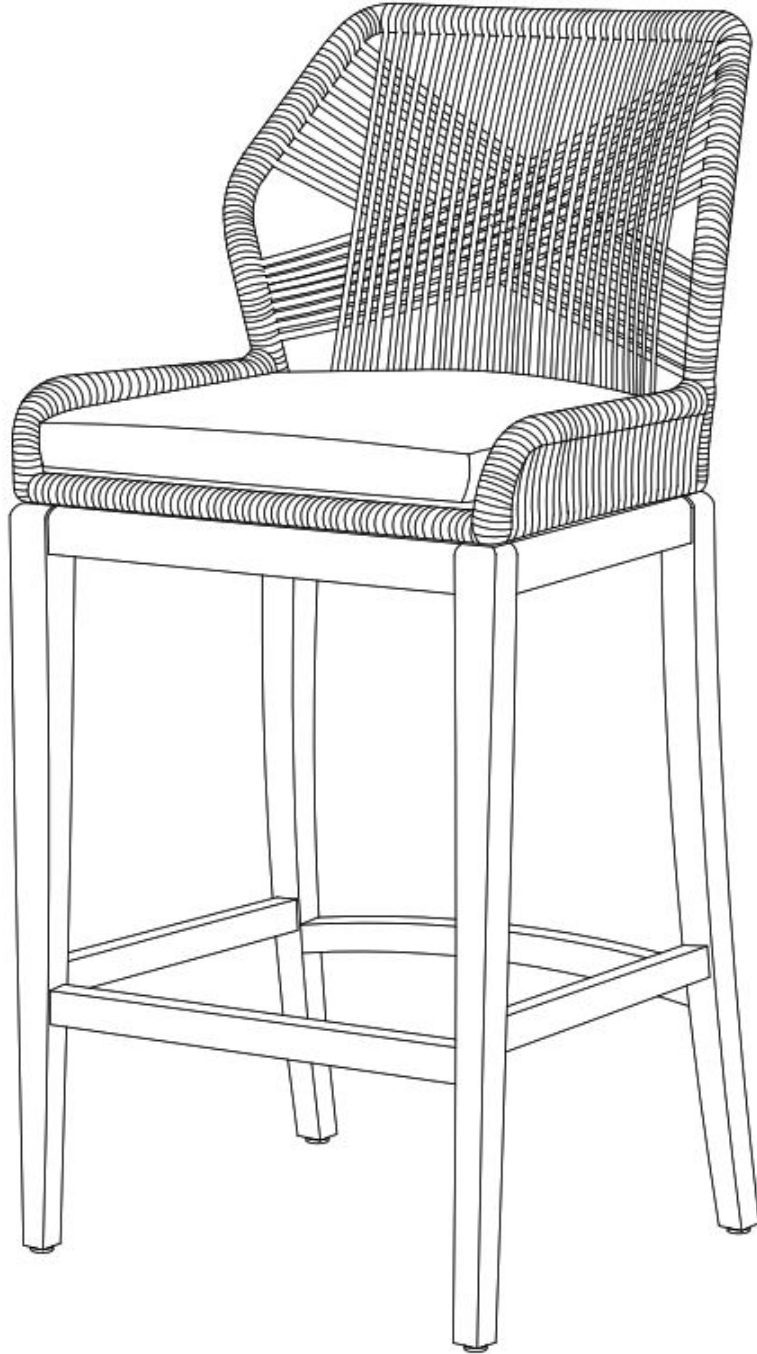

Questions? Contact us!

609.256.9000 • cs@modway.com
www.modway.com

***modway**



Read through all of the instructions before starting



Care instructions are listed in the last step of this manual



Approx. 30 minutes assembly time



Make sure you have all parts and components before discarding any packing materials



2 people recommended for assembly

Only use hand tools to assemble this item. Do not use power tools. Do not tighten bolts or screws completely until all hardware is lined up and inserted into the holes.

Do not over-tighten screws and bolts to avoid stripping the hardware or cracking the item.

Assemble your item on a flat, carpeted area, with plenty of space to work. This will prevent damage and scratches to your floors or the item while you're assembling the product.

Keep all components and packaging out of reach of children or animals to avoid risk of choking or suffocation.

Furniture components:

1 Top Frame x1

2 Cushion x1

3 Bottom Frame x1

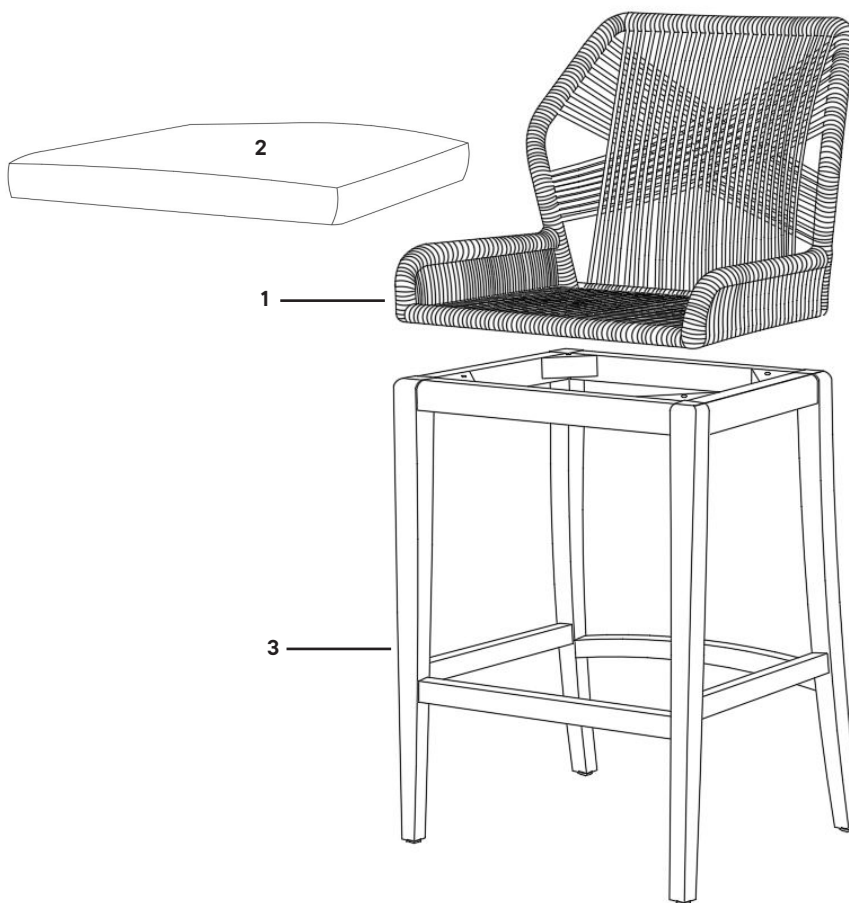

Provided hardware:

A  Bolt M6 x 50 mm x4

B  Allen Key x1

C  Lock Washer x4

D  Flat Washer x4

Wait!

Missing parts or hardware? Need assistance?

Contact us before returning your item. We're here to help!

609.256.9000 • cs@modway.com

Step 1

HARDWARE

- A** Bolt M6 x 50 mm x4
- B** Allen Key x1
- C** Lock Washer x4
- D** Flat Washer x4

COMPONENTS

- 1** Top Frame x1
- 3** Bottom Frame x1

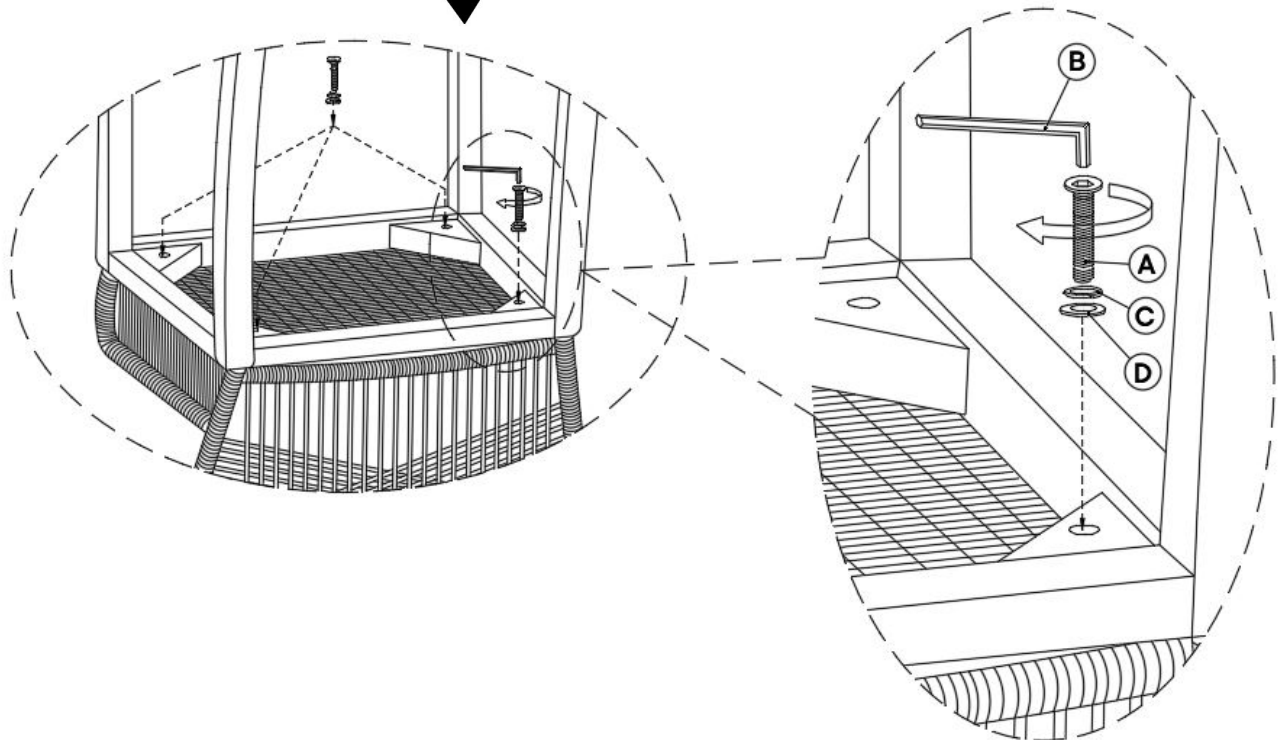
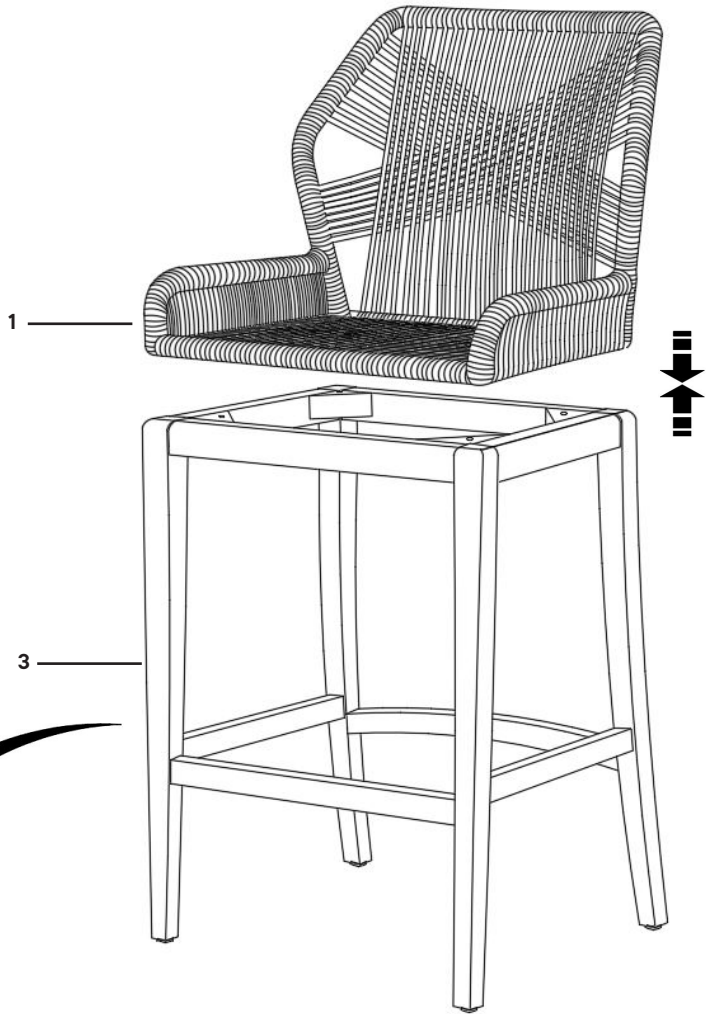

Step 2

COMPONENTS

- 2 Cushion x1

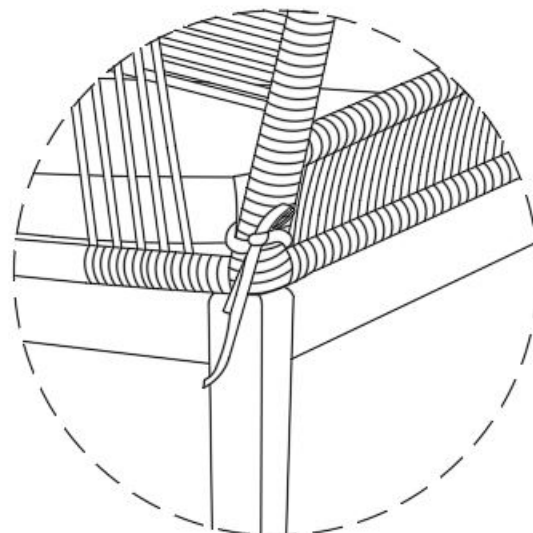
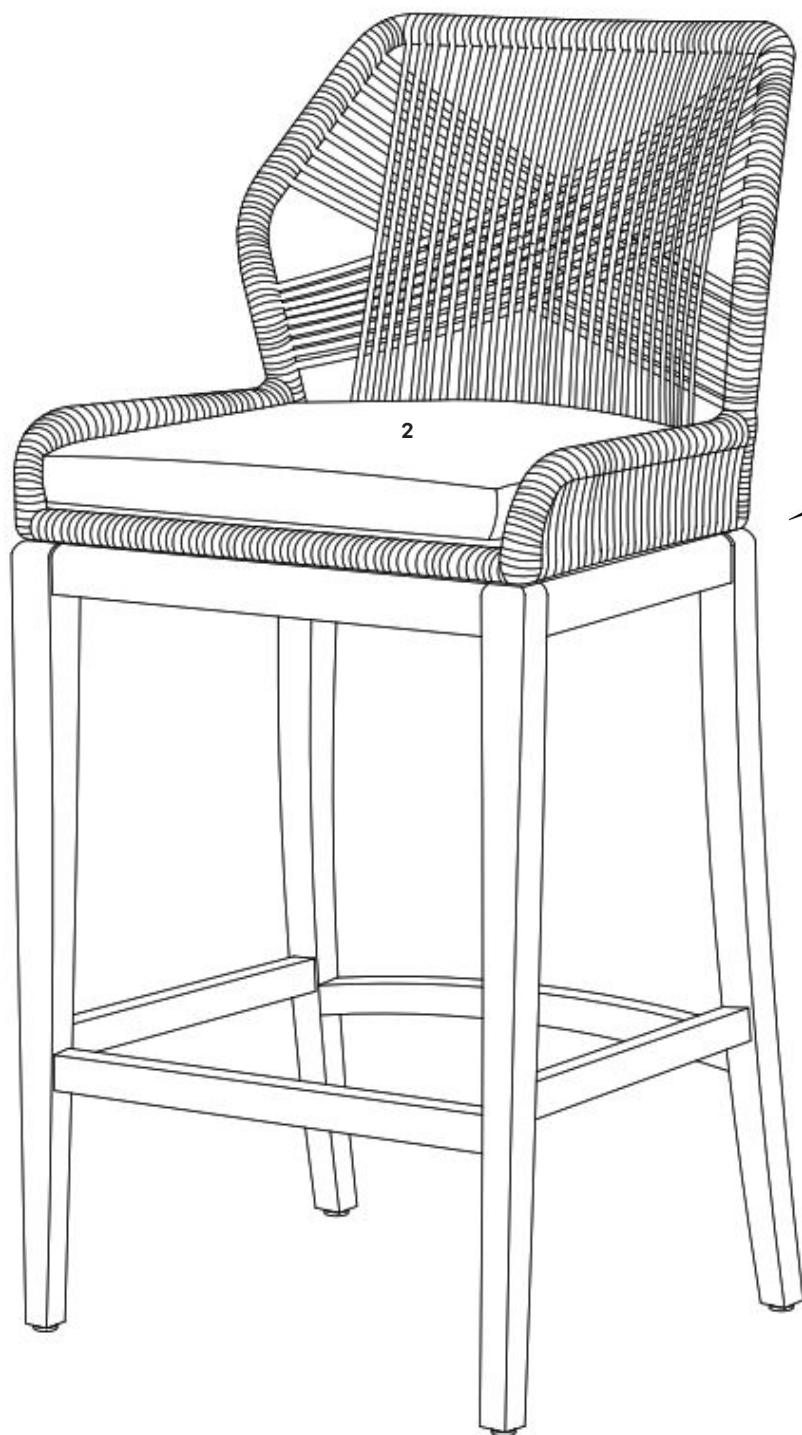

Great job!

Your chair assembly is complete

♥ CARING FOR YOUR ITEM

Depending on use, it may be necessary to tighten the hardware from time to time, so please save the tools that have been provided.

Not contract grade.

Clean using a non-abrasive cloth and a mild cleaner.

Retain the rich wood color by occasionally sanding lightly and applying a teak cleaner and protectant. The oils nourish and help restore the original look.

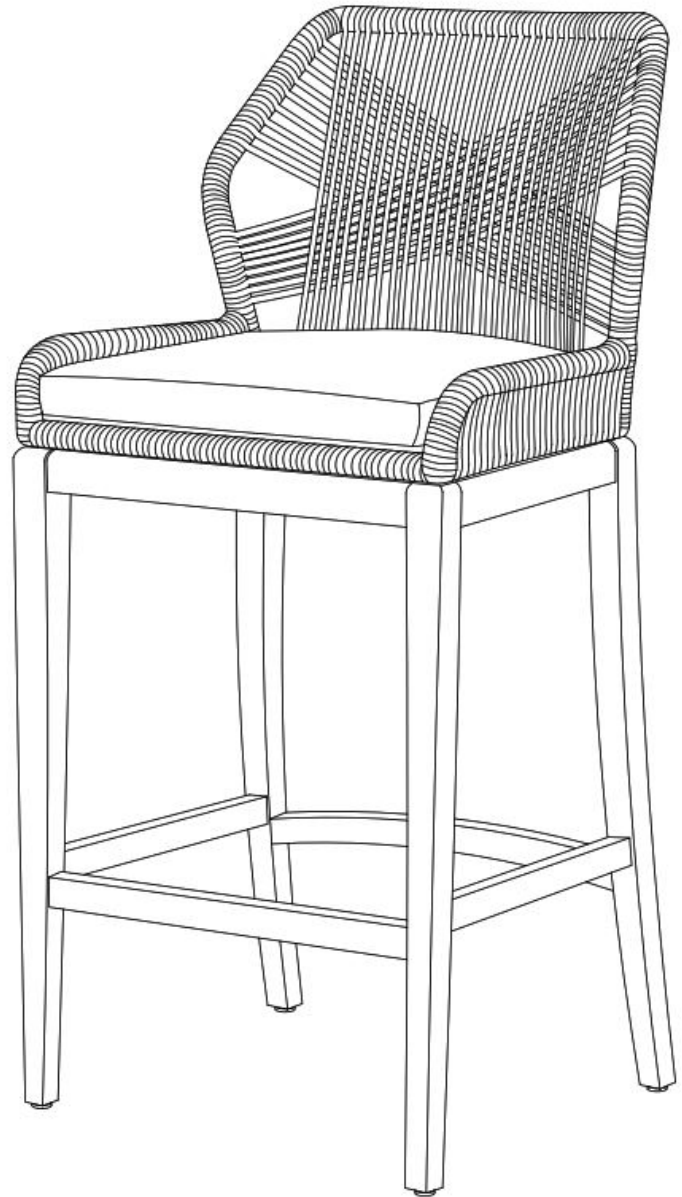

CONNECT WITH US!   

Tag us @modway_furniture and #modway for a chance to be featured.