

How to connect sofa sectional for EEI-2720/ EEI-4621&EEI-2722/ EEI-4622 & EEI-2724/ EEI-4623& EEI-2726/ EEI-4624& EEI-2728/ EEI-4625



Thank you for purchasing the **MODWAY SOFA!**

Before you start, here is some helpful advice:

1. We suggest you spend a short time reading through this leaflet and then follow the simple step-by-step instructions.
2. Owing to the size and weight of the sofa section, we recommend that it is assembled by two adults, on a carpeted or padded area, in the room that it is intended for. Approximate assembly time: 30 minutes.
3. Please do not use any tools other than those provided or recommended in these instructions.
4. Please do not throw away any of the packaging or instructions until you have checked all the components and hardware and the furniture is fully assembled.
5. Assemble all components loosely until advised to tighten. Depending on use, it may be necessary to tighten the components from time to time, so please save the tools that have been provided.
6. Please keep all pieces out of reach of children.

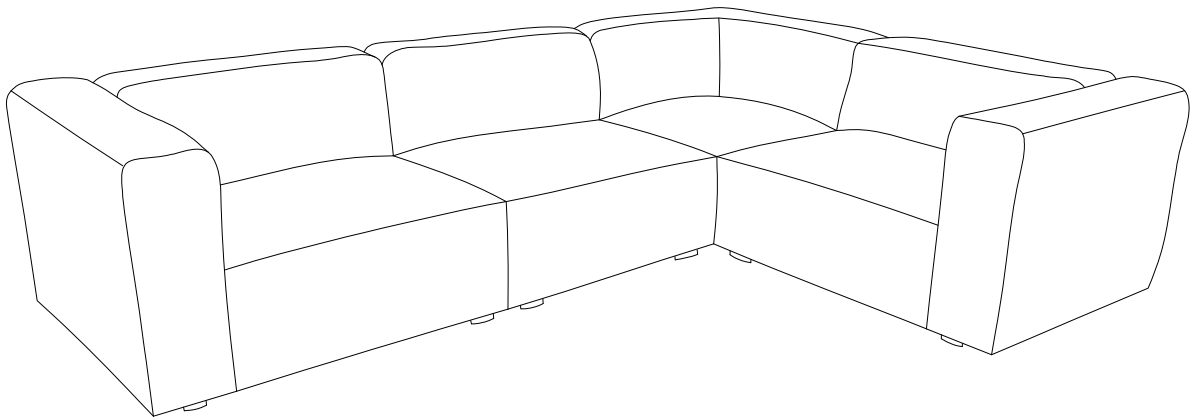

Component:

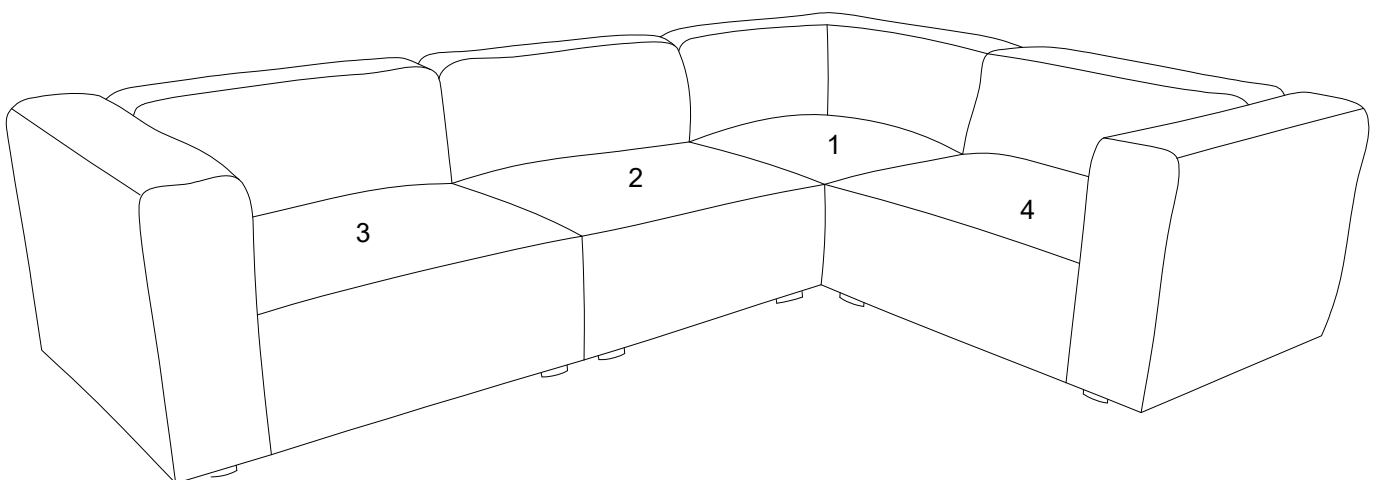

1 EEI-2728/EEI-4625 Corner Seat x1

2 EEI-2724/ EEI-4623 Armless Chair x1

3 EEI-2720/ EEI-4621 Left Arm Chair x1

4 EEI-2722/ EEI-4622 Right Arm Chair x1

STEP 1:

Please carefully place **EEI-2728/4625 Corner Seat (1)** at you desired location.

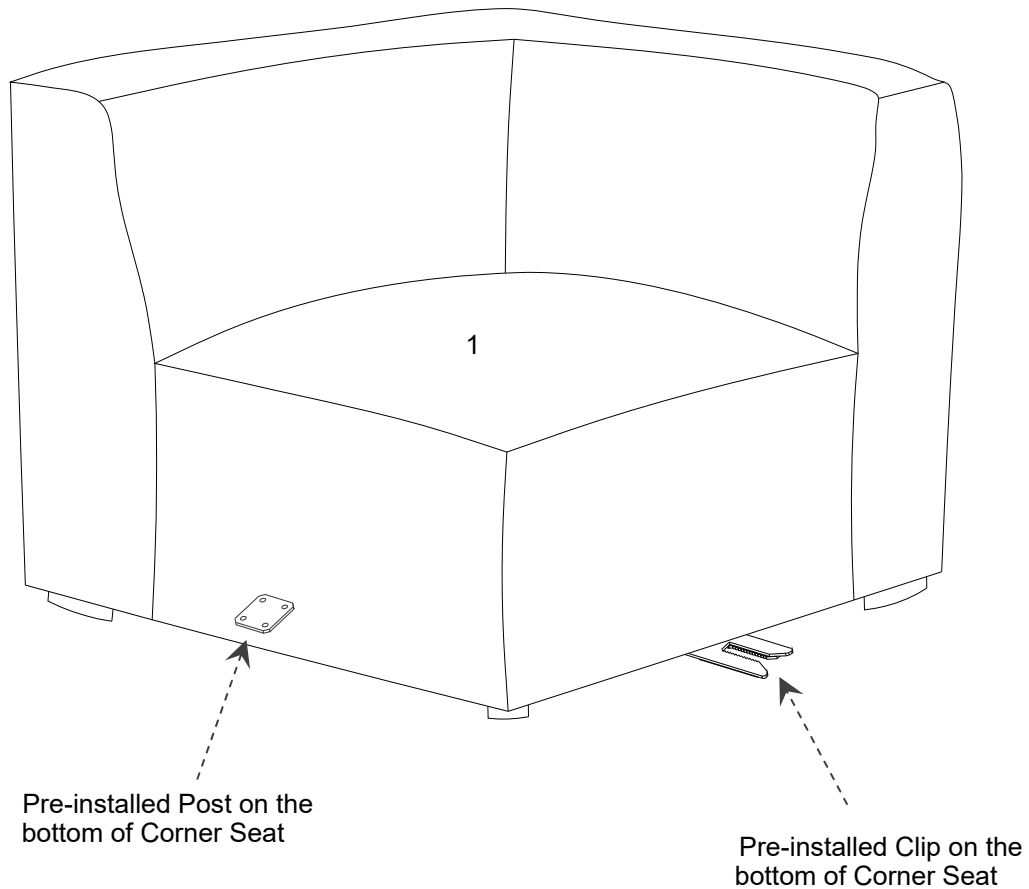

STEP 2:

Put **EEI-2722/4622 Right Arm Chair (4)** and **EEI-2724/4623 Armless Chair(2)** close to **EEI-2728/4625 Corner Seat (1)**. Align the pre-installed Clip to the pre-installed Post as shown.

Push **EEI-2722/4622 Right Arm Chair (4)** and **EEI-2724/4623 Armless Chair (2)** slowly until the Clip and the Post click together tightly.

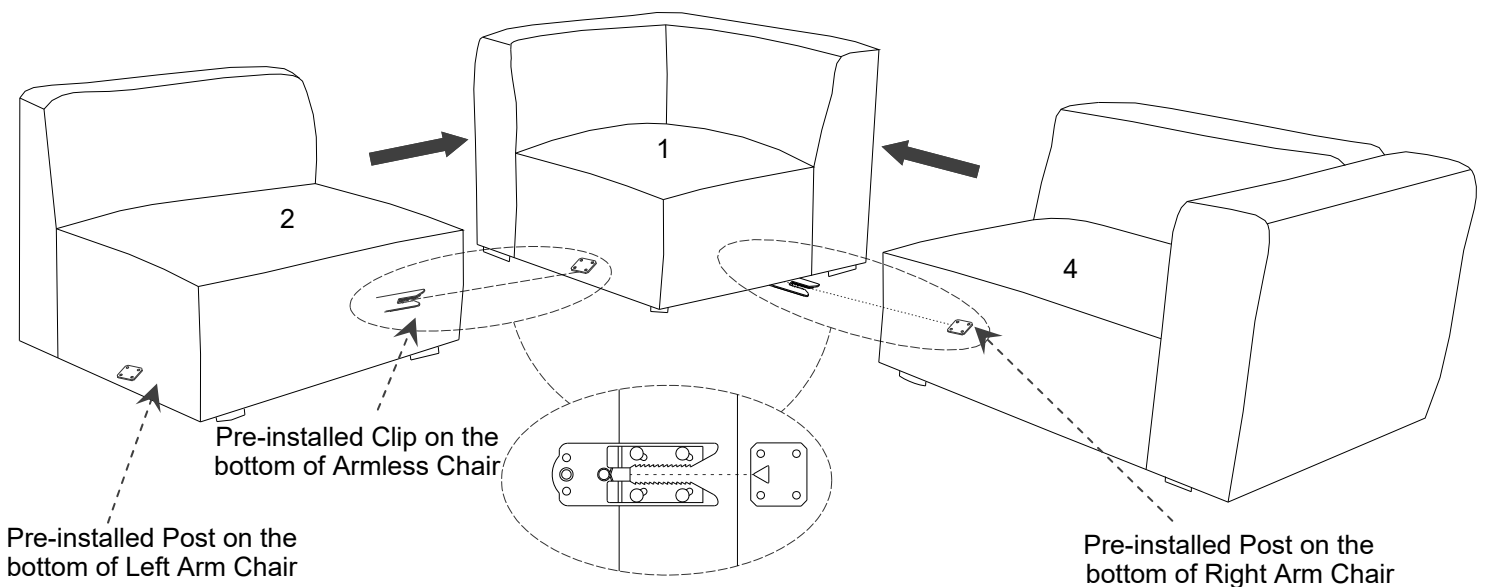

How to connect sofa sectional for EEI-2720/ EEI-4621&EEI-2722/ EEI-4622 & EEI-2724/ EEI-4623& EEI-2726/ EEI-4624& EEI-2728/ EEI-4625



STEP 3:

Put **EEI-2720/4621 Left Arm Chair (3)** close to **EEI-2724/4623 Armless Chair (2)**.

Align the pre-installed Clip to the pre-installed Post as shown.

Push **EEI-2720/4621 Left Arm Chair (3)** slowly until the Clip and the Post click together tightly.

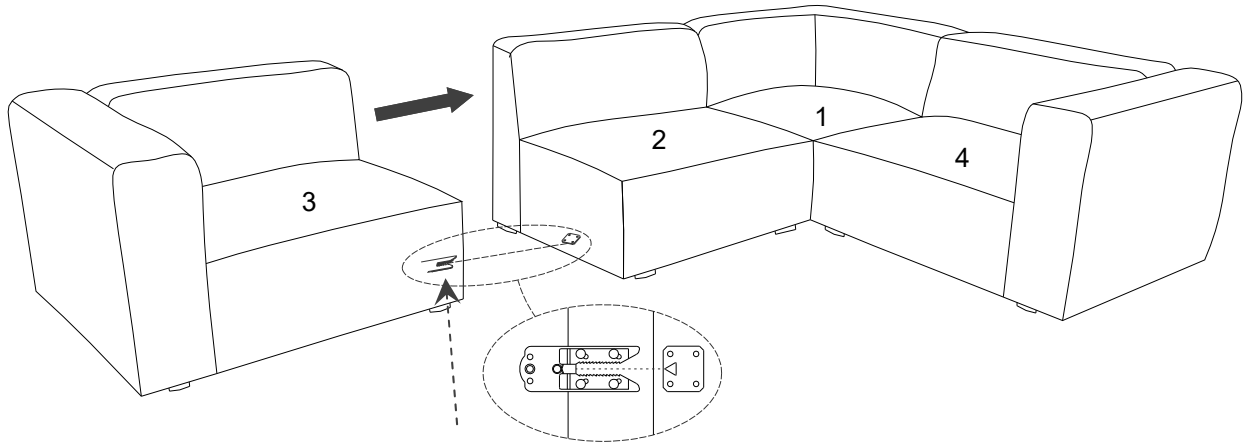

Pre-installed Clip on the bottom of Left Arm Chair

Assembly is complete. Your sofa combination is ready to be used now!

If you want to unlock the sofa combination.

Lift up **EEI-2724/4623 Armless Chair (2)** and move **EEI-2720/4621 Left Arm Chair (3)** apart to **EEI-2724/4623 Armless Chair (2)**.

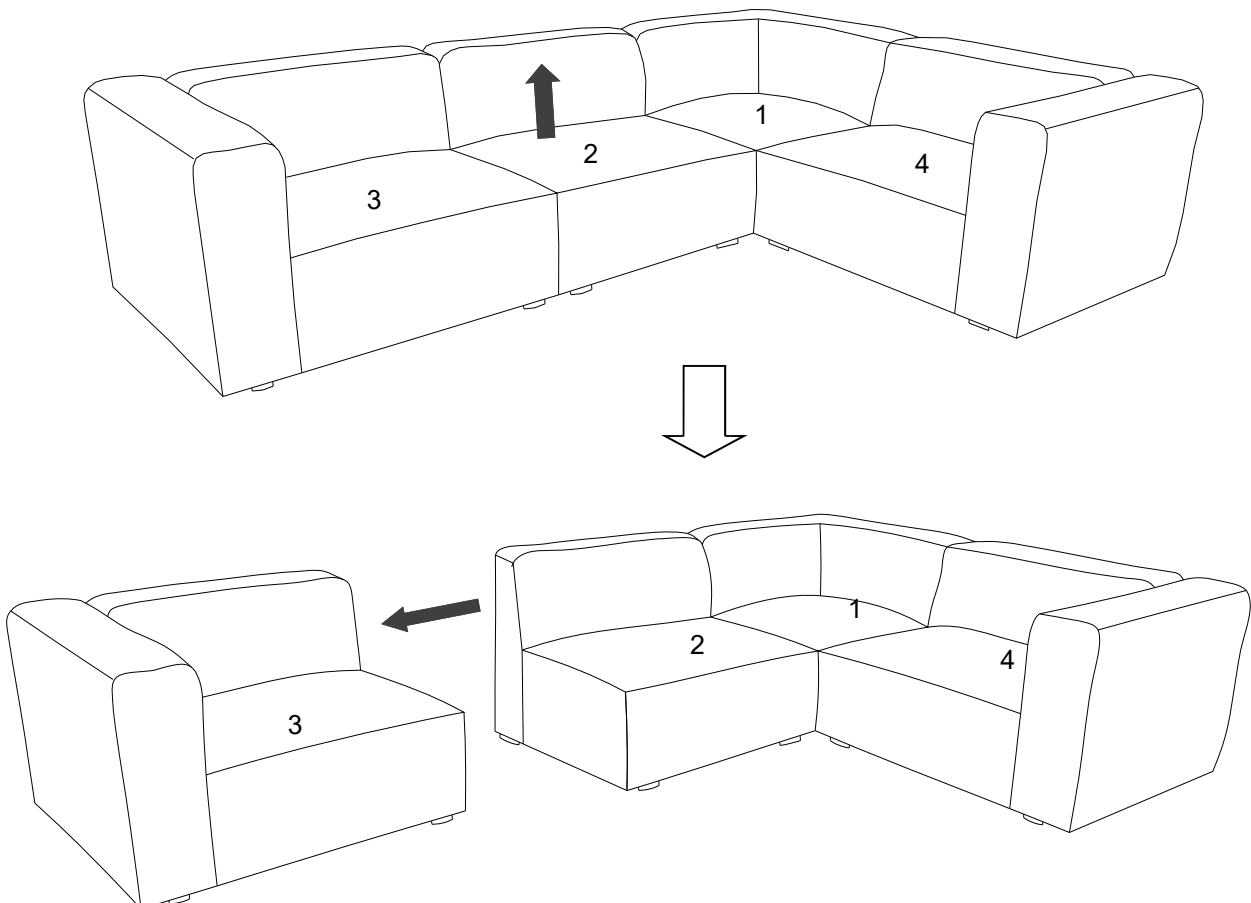

**How to connect sofa sectional for EEI-2720/ EEI-4621&EEI-2722/ EEI-4622
& EEI-2724/ EEI-4623& EEI-2726/ EEI-4624& EEI-2728/ EEI-4625**



Lift up **EEI-2728/4625 Corner Seat (1)** and move **EEI-2724/4623 Armless Chair (2)** apart to **EEI-2728/4625 Corner Seat (1)** as shown.

Lift up **EEI-2722/4622 Right Arm Chair (4)** and move **EEI-2722/4622 Right Arm Chair (4)** apart to **EEI-2728/4625 Corner Seat (1)**.

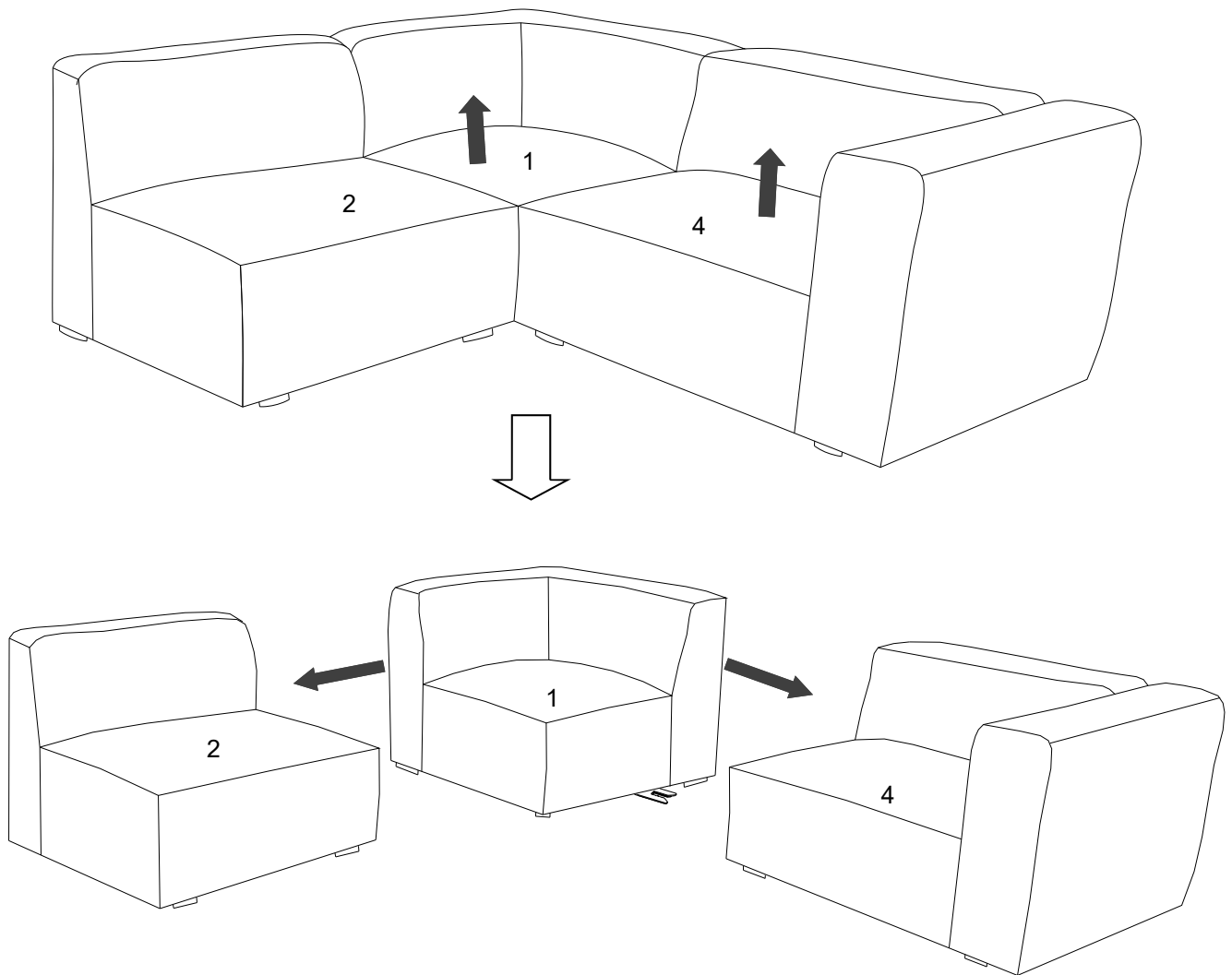

ASSEMBLY FOR EEI-2726/ EEI-4624 OTTOMAN

Please find the extra hardware from **EEI-2726/4624 Ottoman** carton.

Put **EEI-2726/4624 Ottoman** upside down on a carpeted or padded area.





Place the required Post/Clip to the pre-marked position on the bottom of **EEI-2726/4624 Ottoman** as shown.

Insert the **Screws** to the bottom of **EEI-2726/4624 Ottoman** through **Clip/Post** as shown.

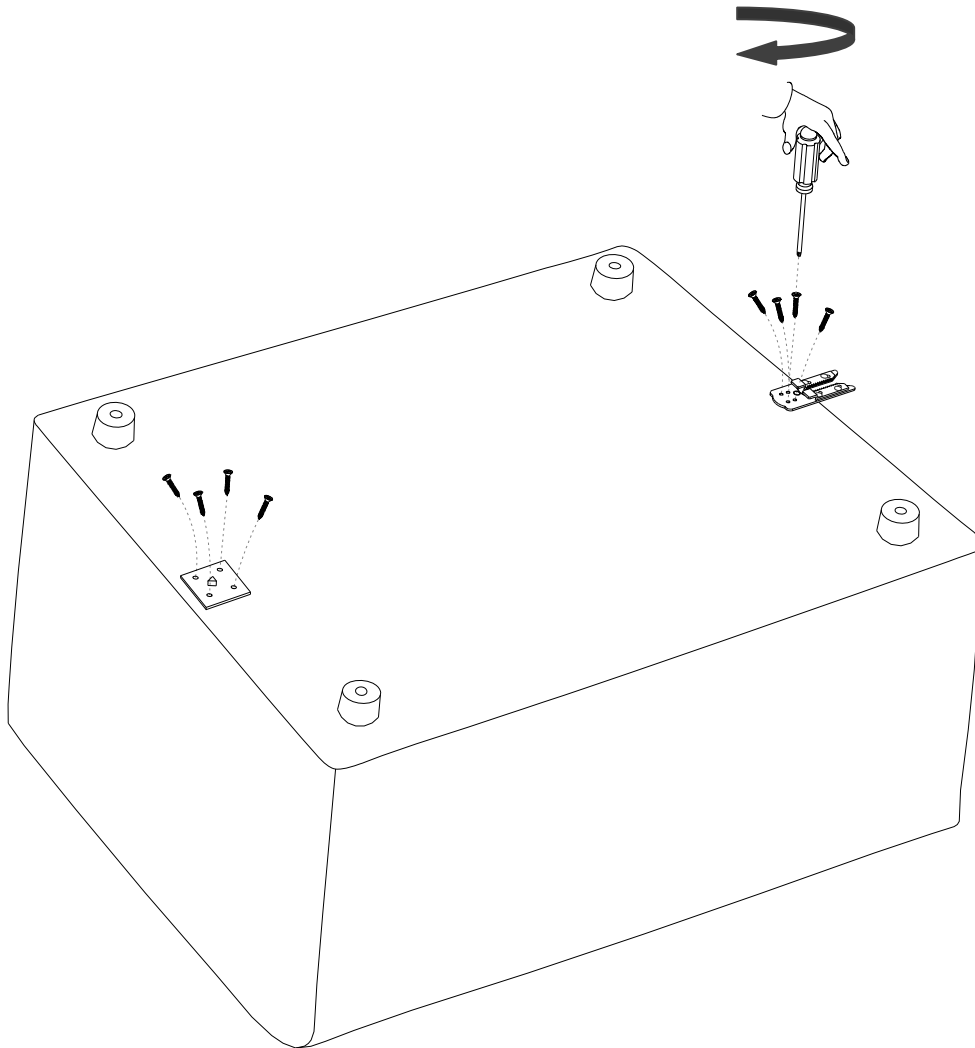
Use **Phillips Head Screwdriver (Not provided)** to tighten **Screws** clockwise until secure.

Repeat the same steps to lock the Clip and Post together tightly.



			
Screw x8	Clip x1	Post x1	Phillips Head Screwdriver (not included)

If you want to lock **EEI-2726/4624 Ottoman** to the sofa combination, the assembly instruction is as the following:

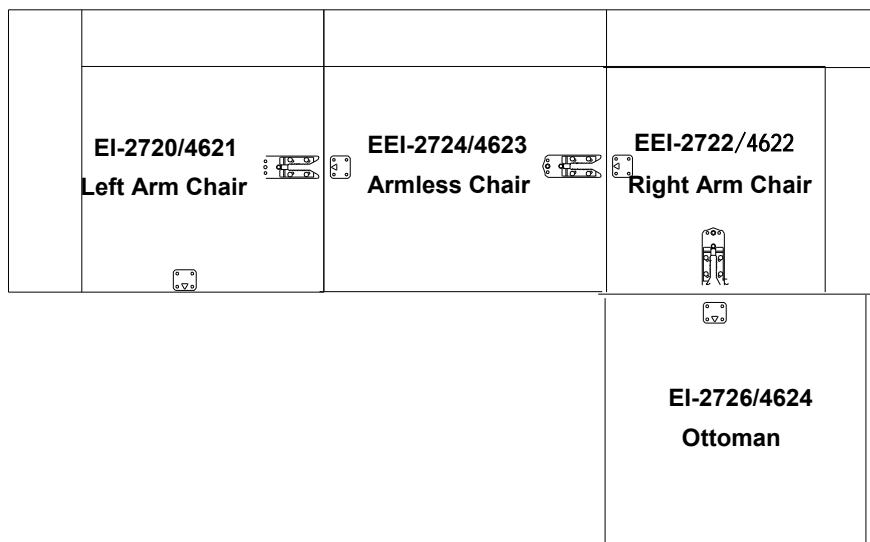
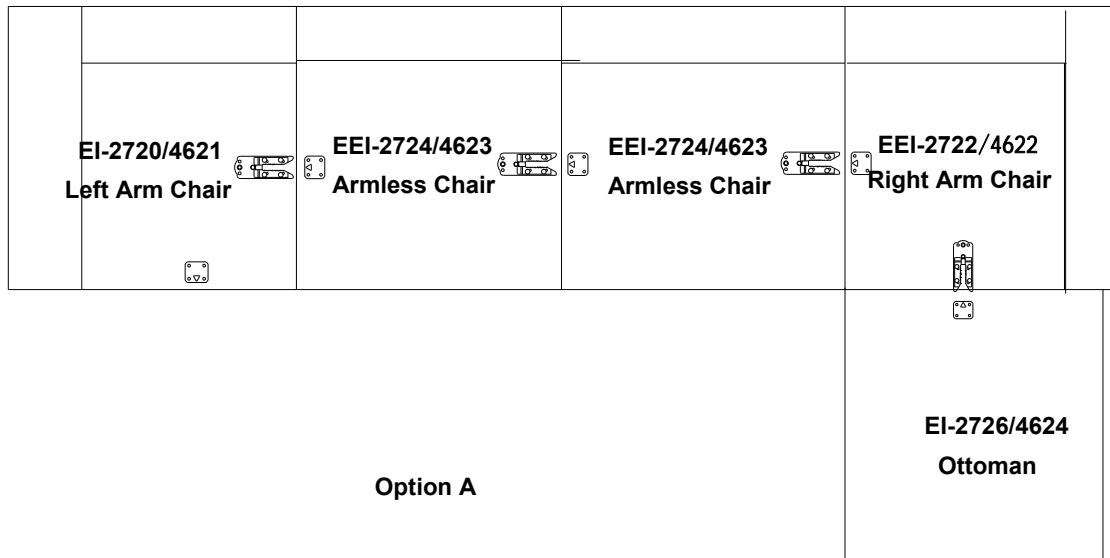

How to connect sofa sectional for EEI-2720/ EEI-4621&EEI-2722/ EEI-4622 & EEI-2724/ EEI-4623& EEI-2726/ EEI-4624& EEI-2728/ EEI-4625



Thank you for purchasing the **MODWAY SOFA!**

Before you start, here is some helpful advice:

1. We suggest you spend a short time reading through this leaflet and then follow the simple step-by-step instructions.
2. Owing to the size and weight of the sofa section, we recommend that it is assembled by two adults, on a carpeted or padded area, in the room that it is intended for. Approximate assembly time: 30 minutes.
3. Please do not use any tools other than those provided or recommended in these instructions.
4. Please do not throw away any of the packaging or instructions until you have checked all the components and hardware and the furniture is fully assembled.
5. Assemble all components loosely until advised to tighten. Depending on use, it may be necessary to tighten the components from time to time, so please save the tools that have been provided.
6. Please keep all pieces out of reach of children.

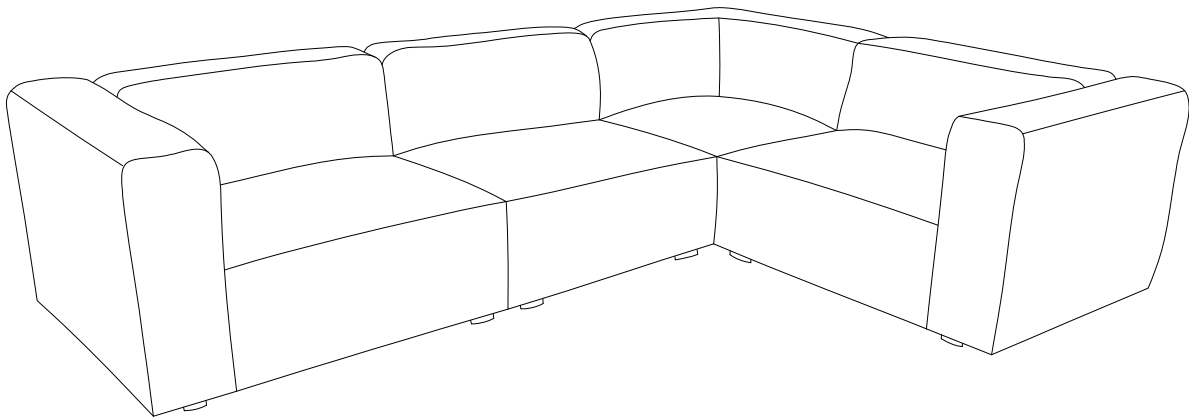

Component:

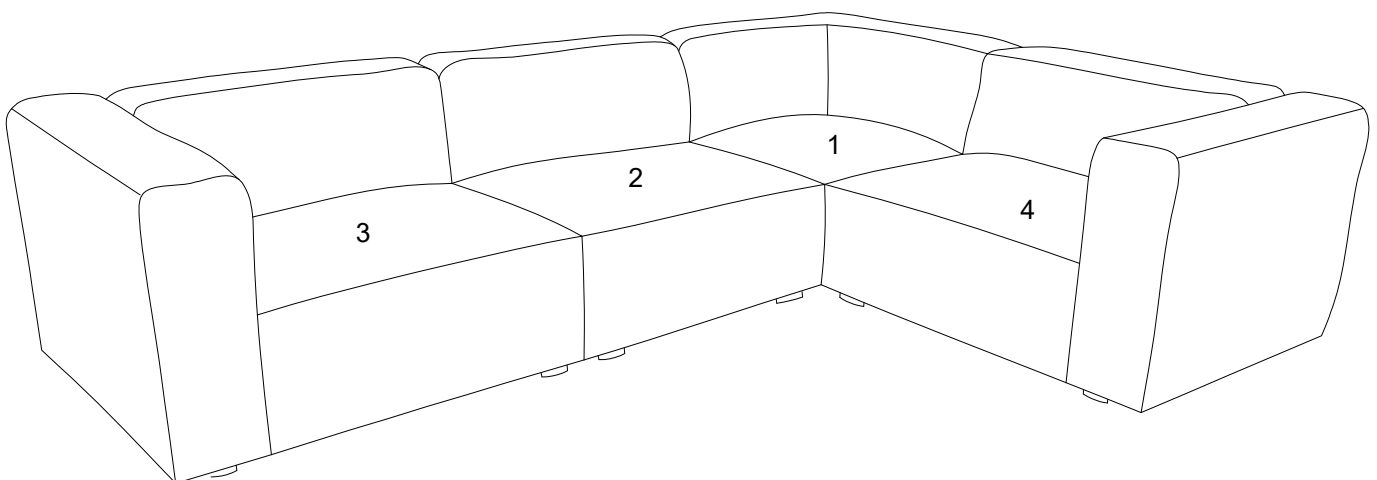

1 EEI-2728/EEI-4625 Corner Seat x1

2 EEI-2724/ EEI-4623 Armless Chair x1

3 EEI-2720/ EEI-4621 Left Arm Chair x1

4 EEI-2722/ EEI-4622 Right Arm Chair x1

STEP 1:

Please carefully place **EEI-2728/4625 Corner Seat (1)** at you desired location.

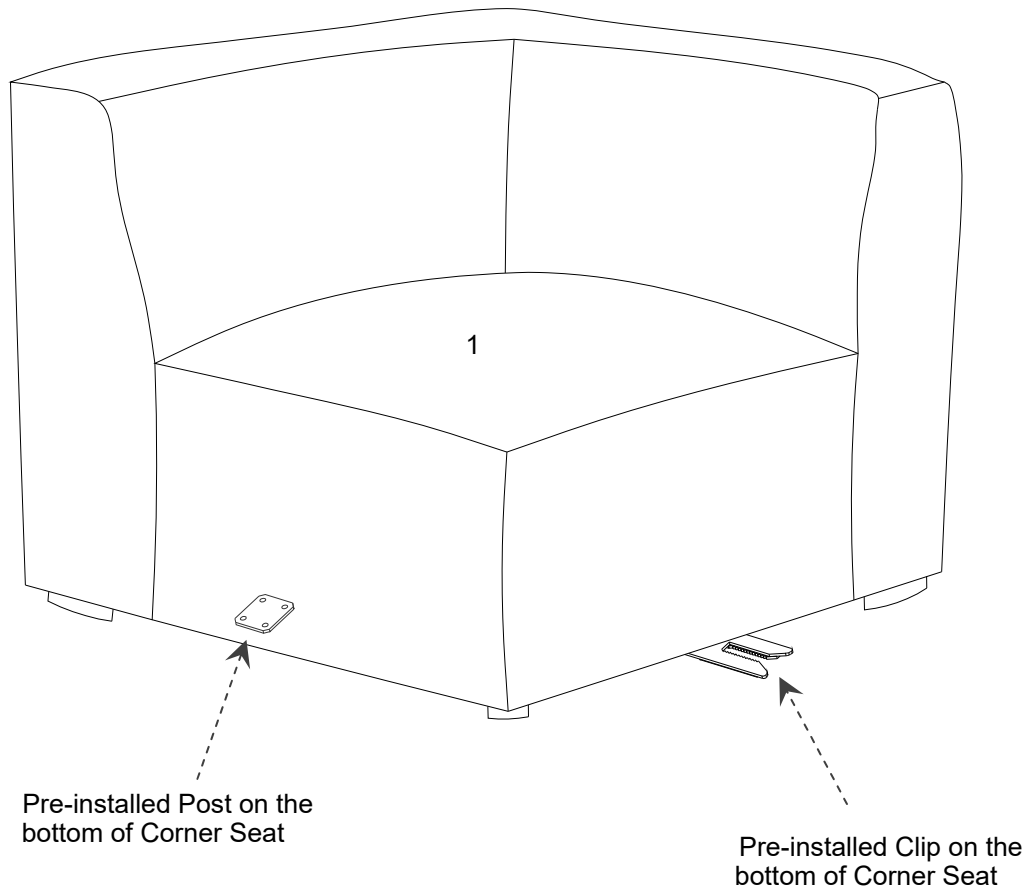

STEP 2:

Put **EEI-2722/4622 Right Arm Chair (4)** and **EEI-2724/4623 Armless Chair(2)** close to **EEI-2728/4625 Corner Seat (1)**. Align the pre-installed Clip to the pre-installed Post as shown.

Push **EEI-2722/4622 Right Arm Chair (4)** and **EEI-2724/4623 Armless Chair (2)** slowly until the Clip and the Post click together tightly.

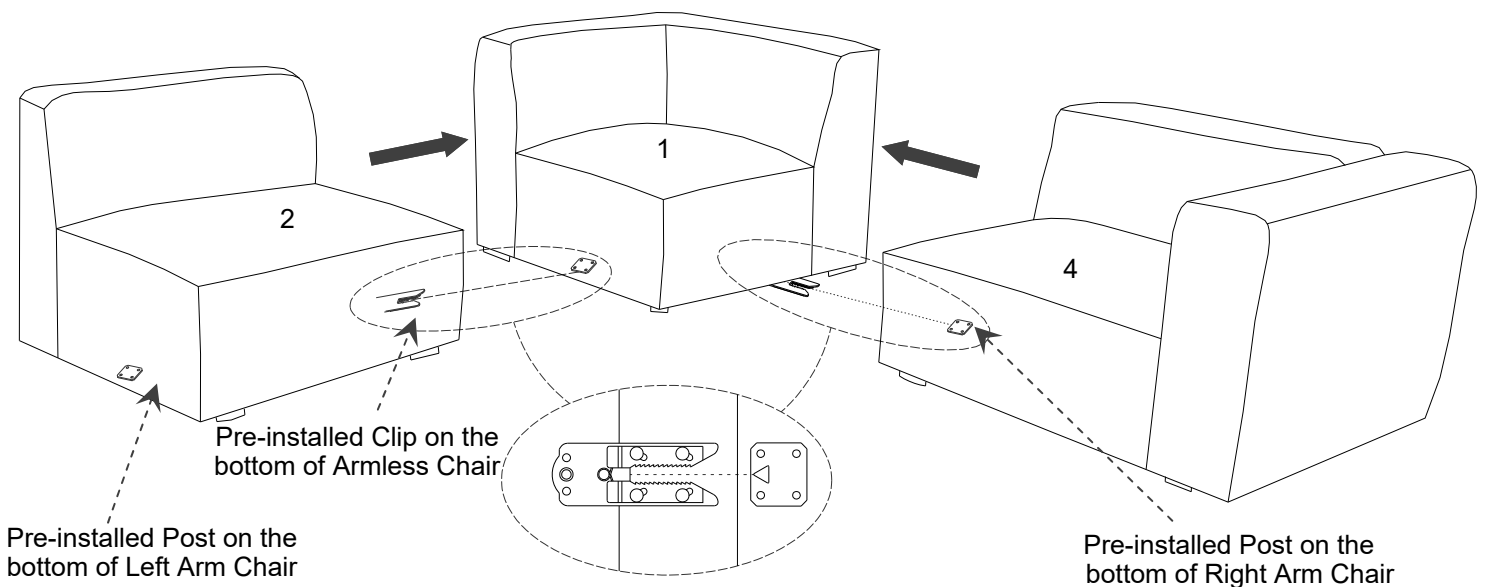

How to connect sofa sectional for EEI-2720/ EEI-4621&EEI-2722/ EEI-4622 & EEI-2724/ EEI-4623& EEI-2726/ EEI-4624& EEI-2728/ EEI-4625



STEP 3:

Put **EEI-2720/4621 Left Arm Chair (3)** close to **EEI-2724/4623 Armless Chair (2)**.

Align the pre-installed Clip to the pre-installed Post as shown.

Push **EEI-2720/4621 Left Arm Chair (3)** slowly until the Clip and the Post click together tightly.

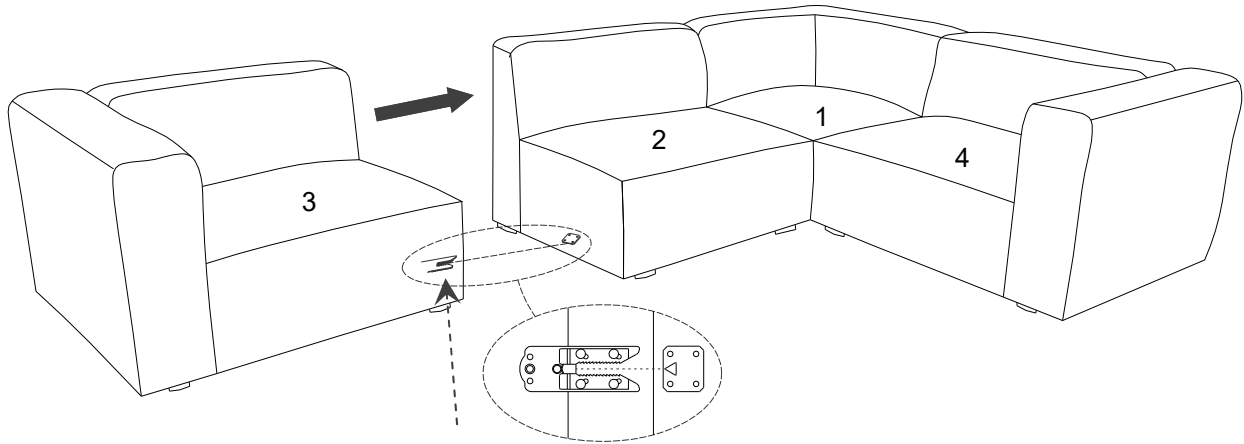

Pre-installed Clip on the bottom of Left Arm Chair

Assembly is complete. Your sofa combination is ready to be used now!

If you want to unlock the sofa combination.

Lift up **EEI-2724/4623 Armless Chair (2)** and move **EEI-2720/4621 Left Arm Chair (3)** apart to **EEI-2724/4623 Armless Chair (2)**.

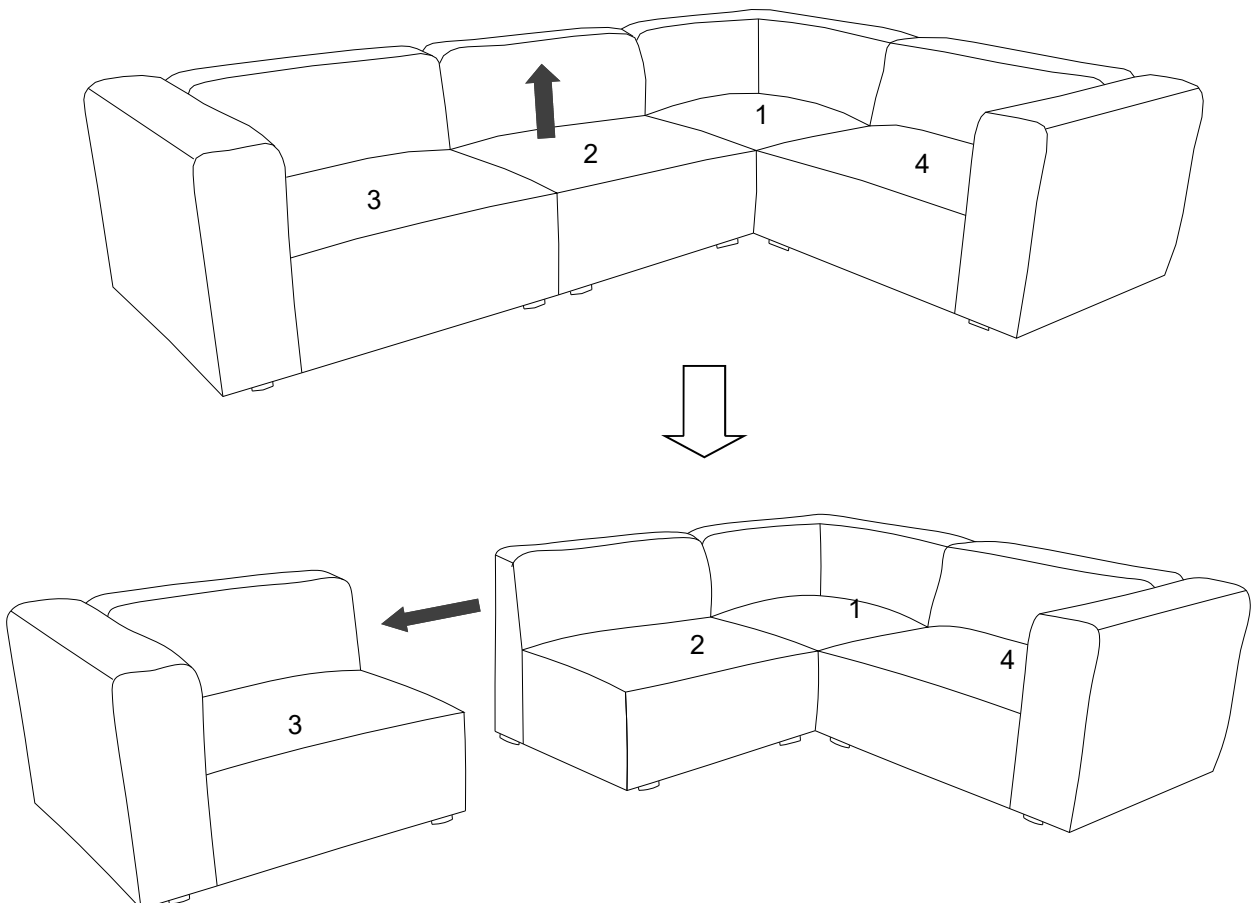

**How to connect sofa sectional for EEI-2720/ EEI-4621&EEI-2722/ EEI-4622
& EEI-2724/ EEI-4623& EEI-2726/ EEI-4624& EEI-2728/ EEI-4625**

Lift up **EEI-2728/4625 Corner Seat (1)** and move **EEI-2724/4623 Armless Chair (2)** apart to **EEI-2728/4625 Corner Seat (1)** as shown.

Lift up **EEI-2722/4622 Right Arm Chair (4)** and move **EEI-2722/4622 Right Arm Chair (4)** apart to **EEI-2728/4625 Corner Seat (1)**.

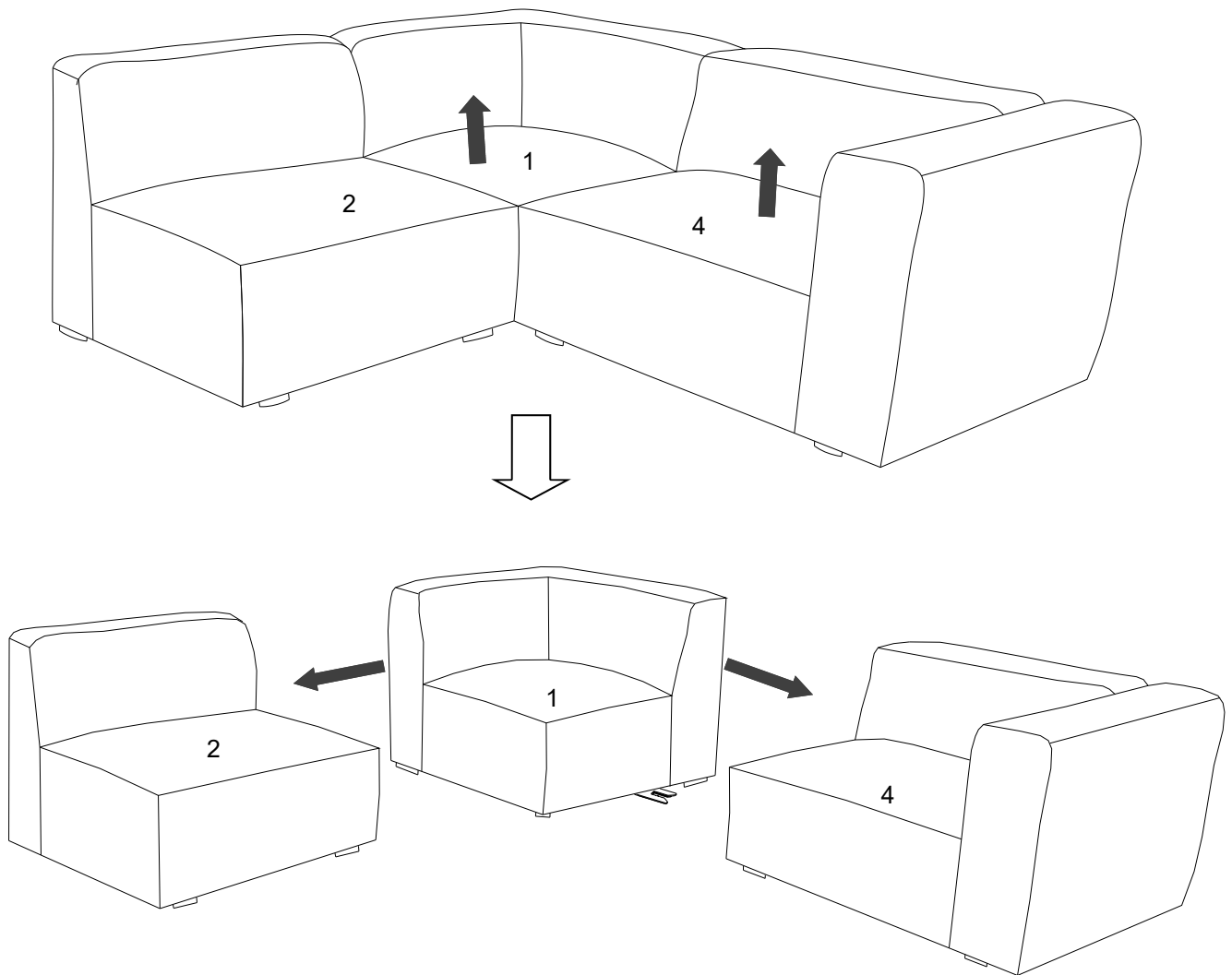

ASSEMBLY FOR EEI-2726/ EEI-4624 OTTOMAN

Please find the extra hardware from **EEI-2726/4624 Ottoman** carton.

Put **EEI-2726/4624 Ottoman** upside down on a carpeted or padded area.





Place the required Post/Clip to the pre-marked position on the bottom of **EEI-2726/4624 Ottoman** as shown.

Insert the **Screws** to the bottom of **EEI-2726/4624 Ottoman** through **Clip/Post** as shown.

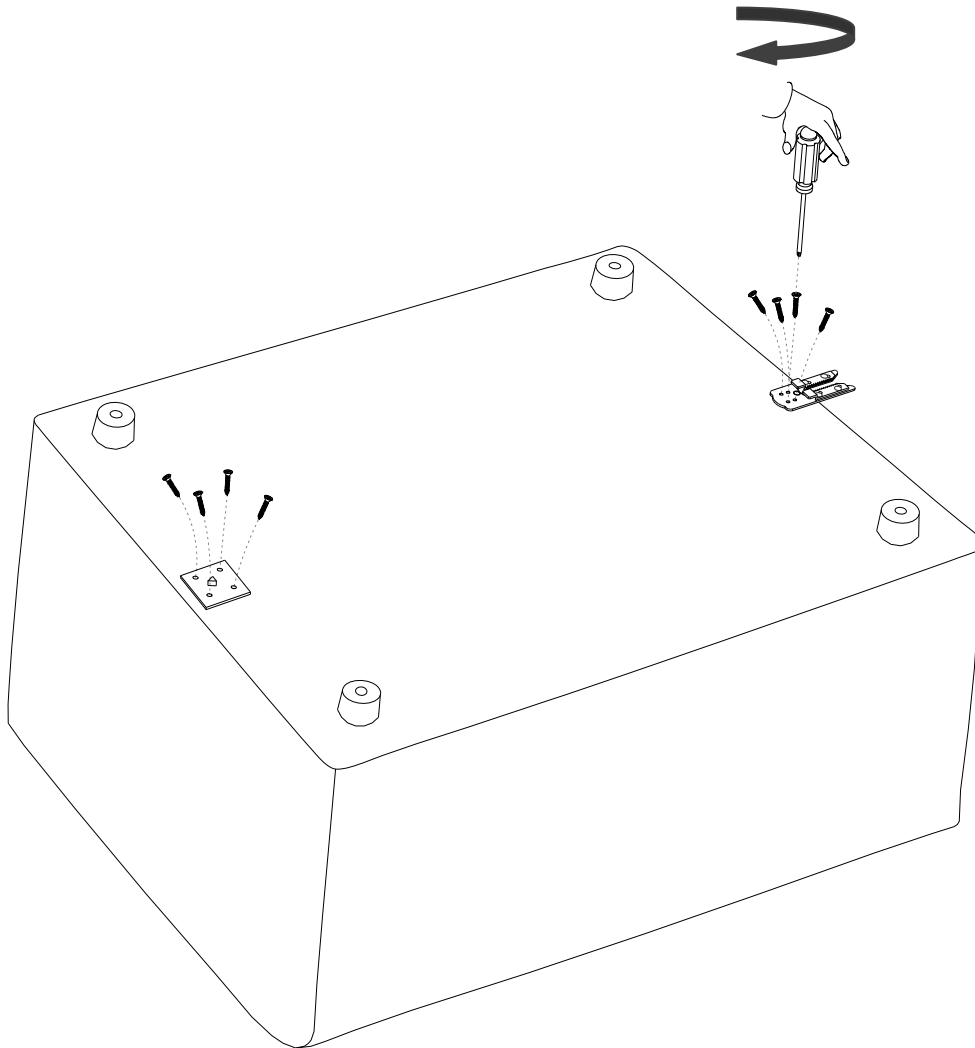
Use **Phillips Head Screwdriver (Not provided)** to tighten **Screws** clockwise until secure.

Repeat the same steps to lock the Clip and Post together tightly.



			
Screw x8	Clip x1	Post x1	Phillips Head Screwdriver (not included)

If you want to lock **EEI-2726/4624 Ottoman** to the sofa combination, the assembly instruction is as the following:

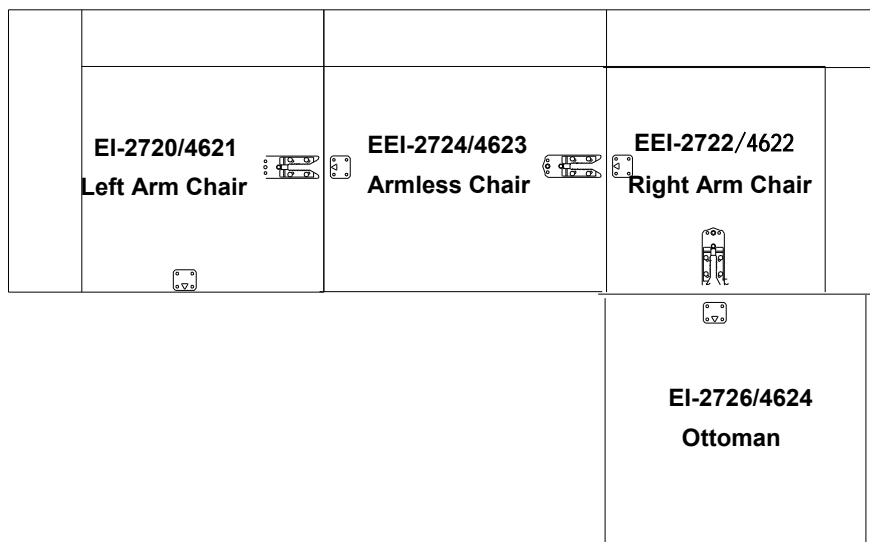
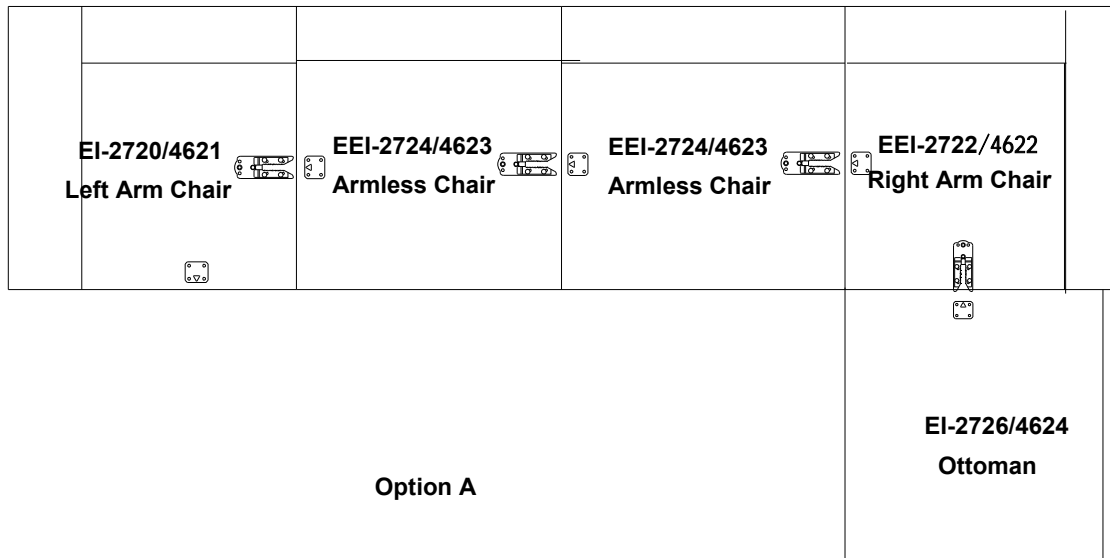

How to connect sofa sectional for EEI-2720/ EEI-4621&EEI-2722/ EEI-4622 & EEI-2724/ EEI-4623& EEI-2726/ EEI-4624& EEI-2728/ EEI-4625



Thank you for purchasing the **MODWAY SOFA!**

Before you start, here is some helpful advice:

1. We suggest you spend a short time reading through this leaflet and then follow the simple step-by-step instructions.
2. Owing to the size and weight of the sofa section, we recommend that it is assembled by two adults, on a carpeted or padded area, in the room that it is intended for. Approximate assembly time: 30 minutes.
3. Please do not use any tools other than those provided or recommended in these instructions.
4. Please do not throw away any of the packaging or instructions until you have checked all the components and hardware and the furniture is fully assembled.
5. Assemble all components loosely until advised to tighten. Depending on use, it may be necessary to tighten the components from time to time, so please save the tools that have been provided.
6. Please keep all pieces out of reach of children.

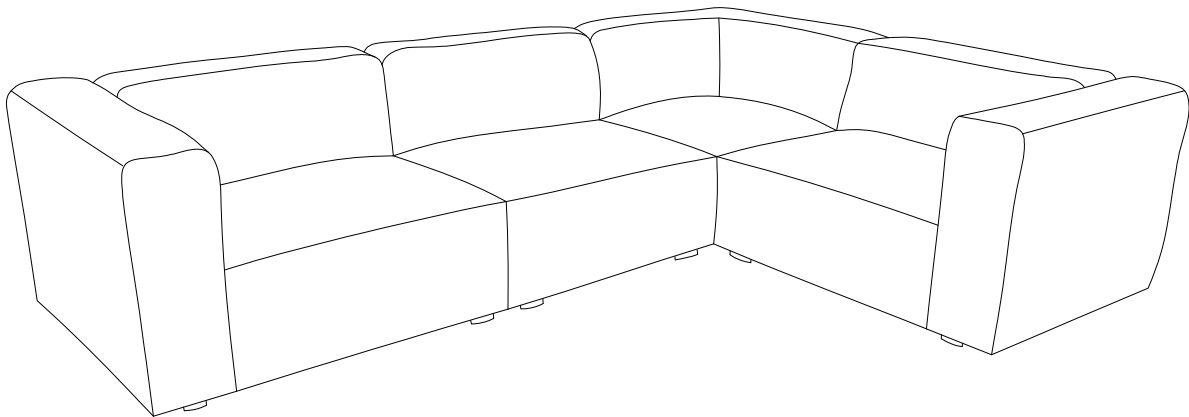

Component:

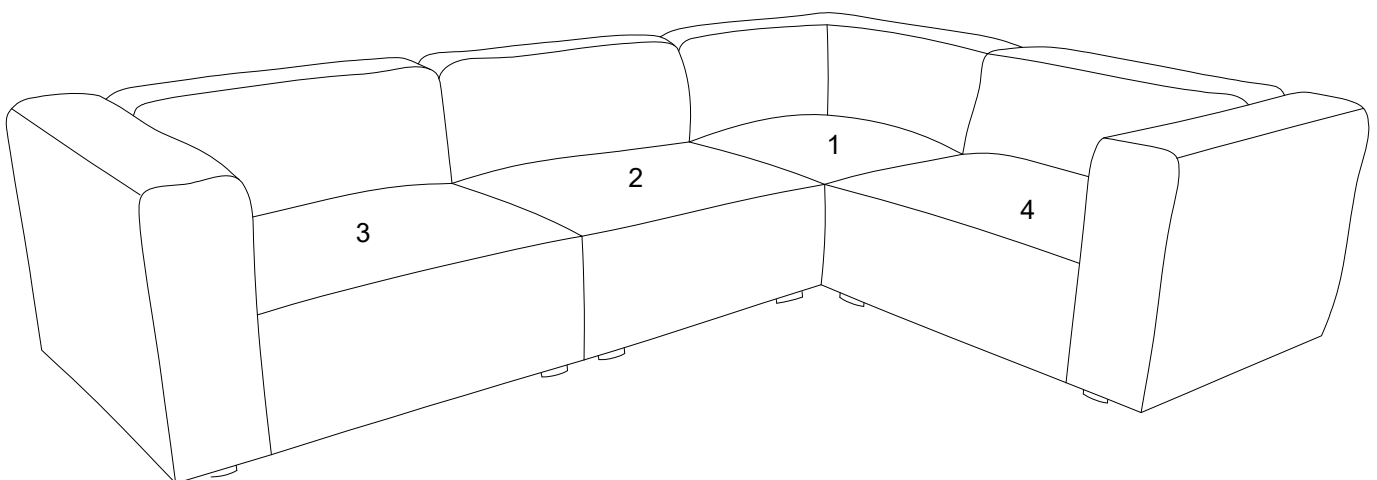

1 EEI-2728/EEI-4625 Corner Seat x1

2 EEI-2724/ EEI-4623 Armless Chair x1

3 EEI-2720/ EEI-4621 Left Arm Chair x1

4 EEI-2722/ EEI-4622 Right Arm Chair x1

STEP 1:

Please carefully place **EEI-2728/4625 Corner Seat (1)** at you desired location.

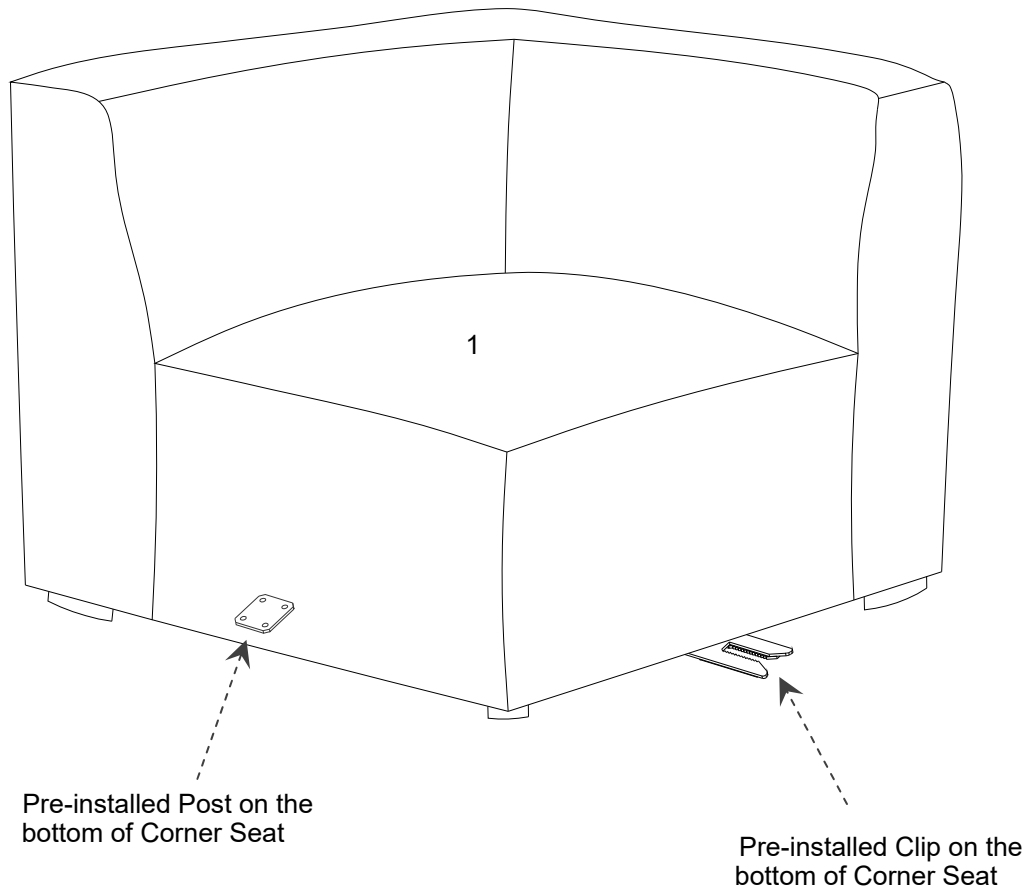

STEP 2:

Put **EEI-2722/4622 Right Arm Chair (4)** and **EEI-2724/4623 Armless Chair(2)** close to **EEI-2728/4625 Corner Seat (1)**. Align the pre-installed Clip to the pre-installed Post as shown.

Push **EEI-2722/4622 Right Arm Chair (4)** and **EEI-2724/4623 Armless Chair (2)** slowly until the Clip and the Post click together tightly.

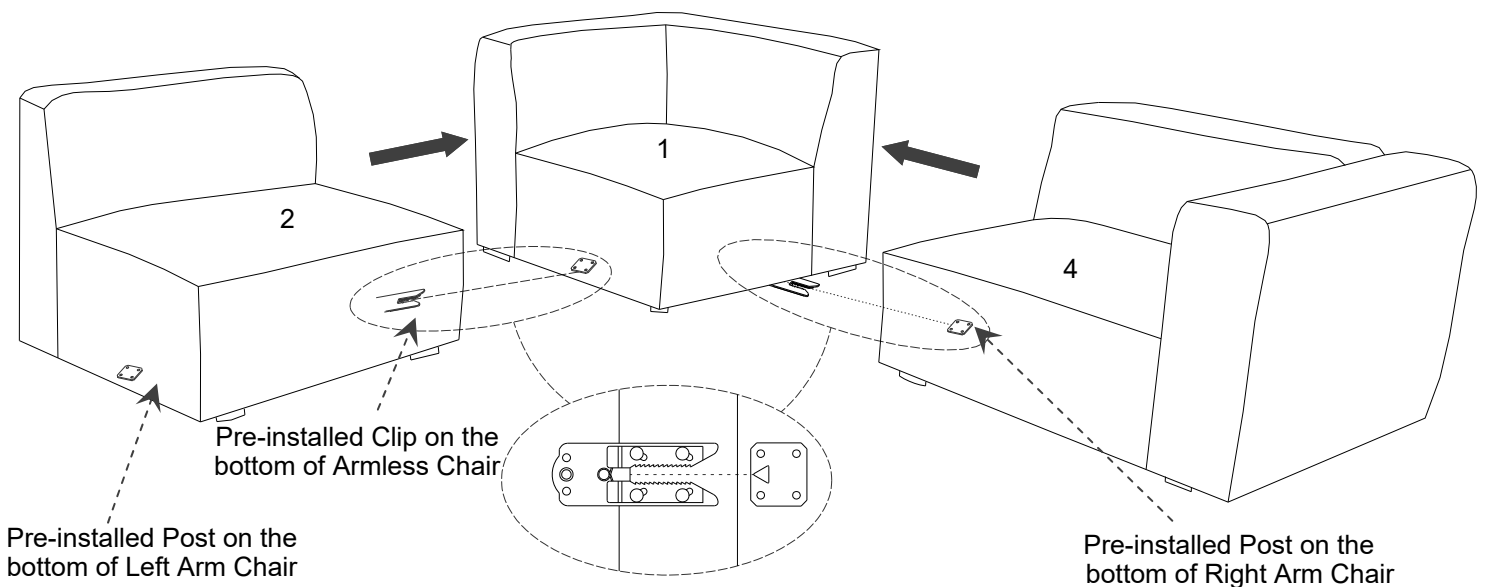

How to connect sofa sectional for EEI-2720/ EEI-4621&EEI-2722/ EEI-4622 & EEI-2724/ EEI-4623& EEI-2726/ EEI-4624& EEI-2728/ EEI-4625

STEP 3:

Put **EEI-2720/4621 Left Arm Chair (3)** close to **EEI-2724/4623 Armless Chair (2)**.

Align the pre-installed Clip to the pre-installed Post as shown.

Push **EEI-2720/4621 Left Arm Chair (3)** slowly until the Clip and the Post click together tightly.

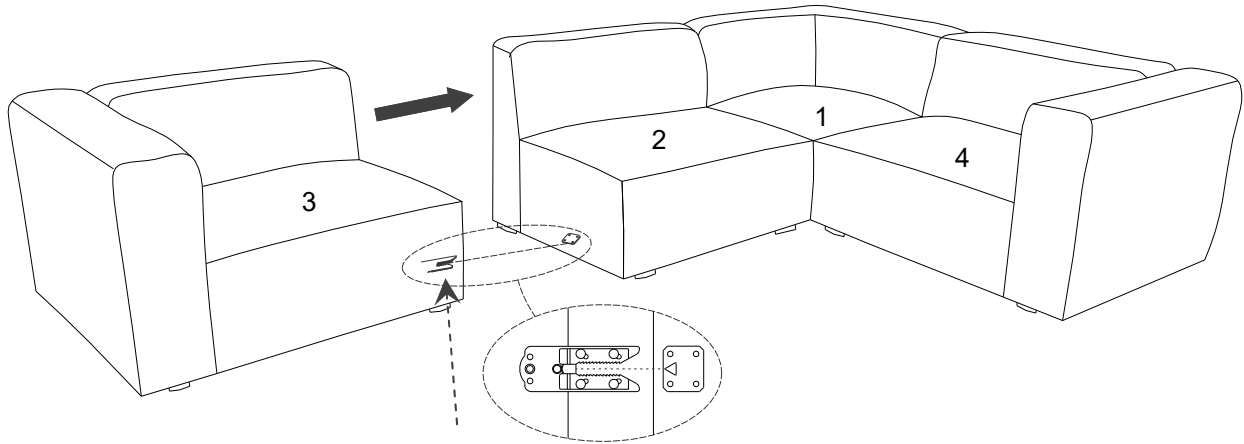

Pre-installed Clip on the bottom of Left Arm Chair

Assembly is complete. Your sofa combination is ready to be used now!

If you want to unlock the sofa combination.

Lift up **EEI-2724/4623 Armless Chair (2)** and move **EEI-2720/4621 Left Arm Chair (3)** apart to **EEI-2724/4623 Armless Chair (2)**.

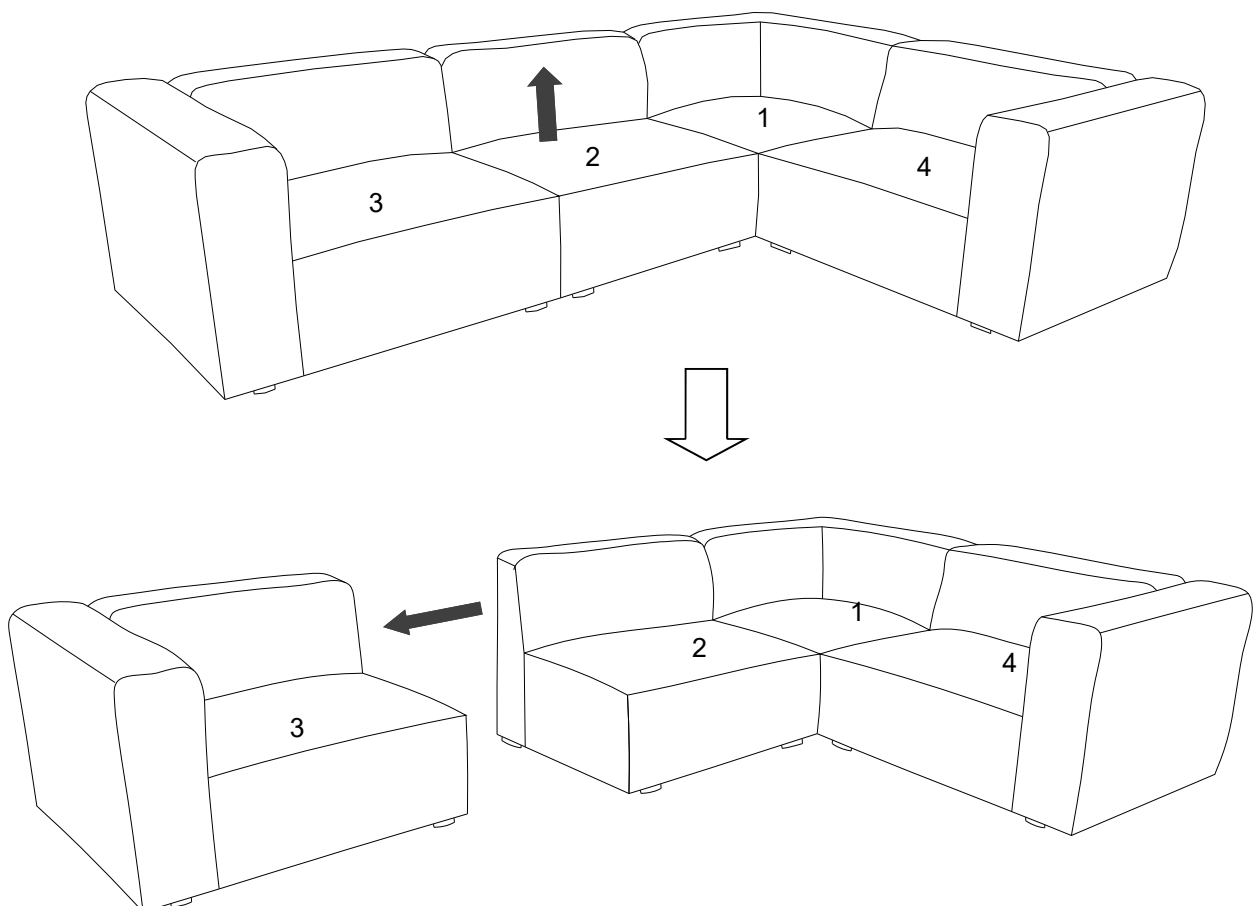

**How to connect sofa sectional for EEI-2720/ EEI-4621&EEI-2722/ EEI-4622
& EEI-2724/ EEI-4623& EEI-2726/ EEI-4624& EEI-2728/ EEI-4625**



Lift up **EEI-2728/4625 Corner Seat (1)** and move **EEI-2724/4623 Armless Chair (2)** apart to **EEI-2728/4625 Corner Seat (1)** as shown.

Lift up **EEI-2722/4622 Right Arm Chair (4)** and move **EEI-2722/4622 Right Arm Chair (4)** apart to **EEI-2728/4625 Corner Seat (1)**.

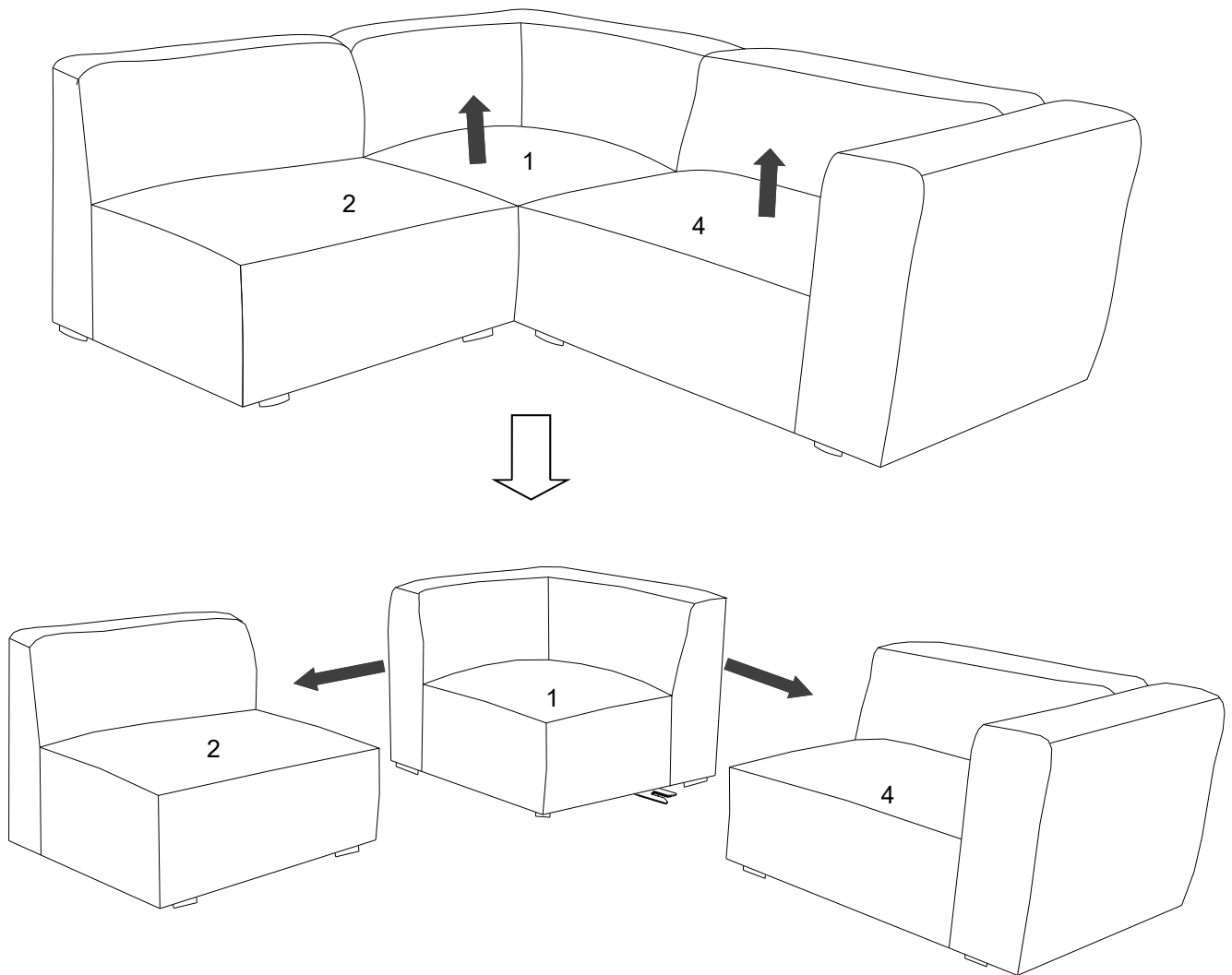

ASSEMBLY FOR EEI-2726/ EEI-4624 OTTOMAN

Please find the extra hardware from **EEI-2726/4624 Ottoman** carton.

Put **EEI-2726/4624 Ottoman** upside down on a carpeted or padded area.





Place the required Post/Clip to the pre-marked position on the bottom of **EEI-2726/4624 Ottoman** as shown.

Insert the **Screws** to the bottom of **EEI-2726/4624 Ottoman** through **Clip/Post** as shown.

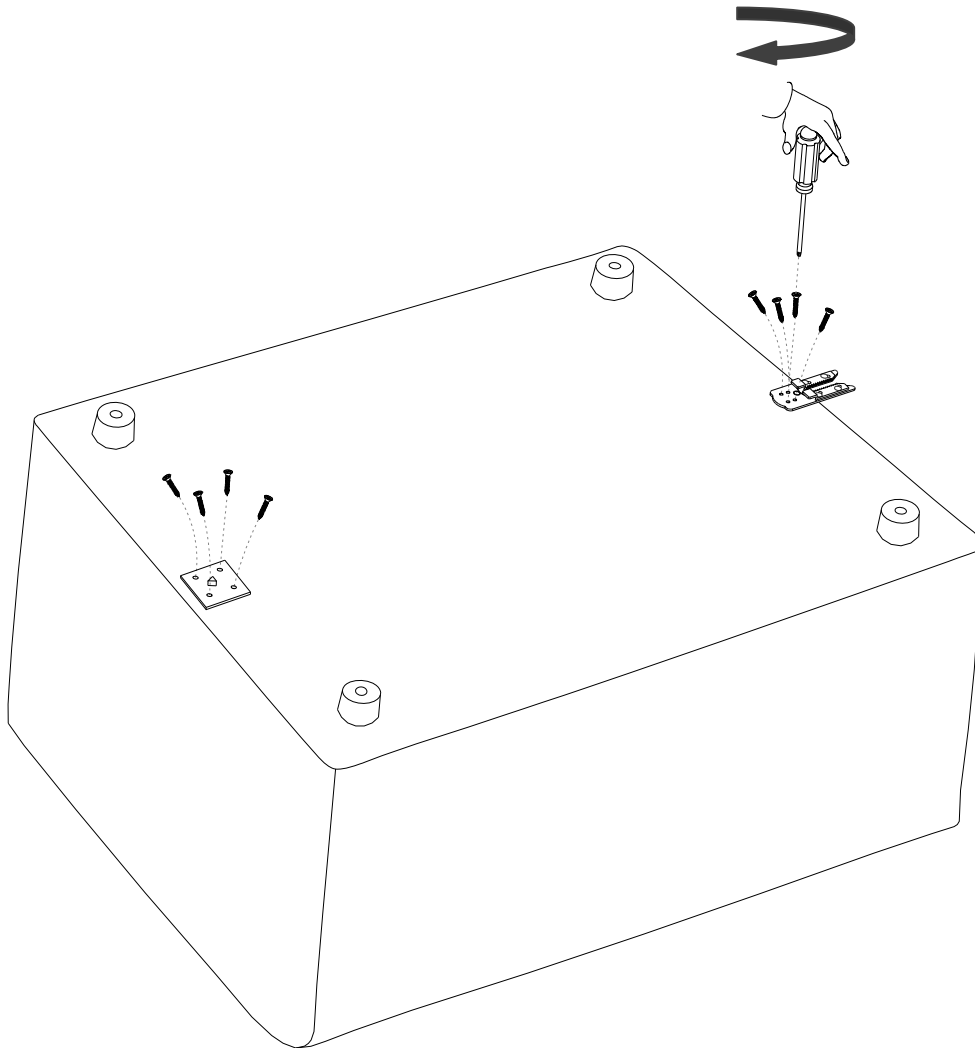
Use **Phillips Head Screwdriver (Not provided)** to tighten **Screws** clockwise until secure.

Repeat the same steps to lock the Clip and Post together tightly.



			
Screw x8	Clip x1	Post x1	Phillips Head Screwdriver (not included)

If you want to lock **EEI-2726/4624 Ottoman** to the sofa combination, the assembly instruction is as the following:

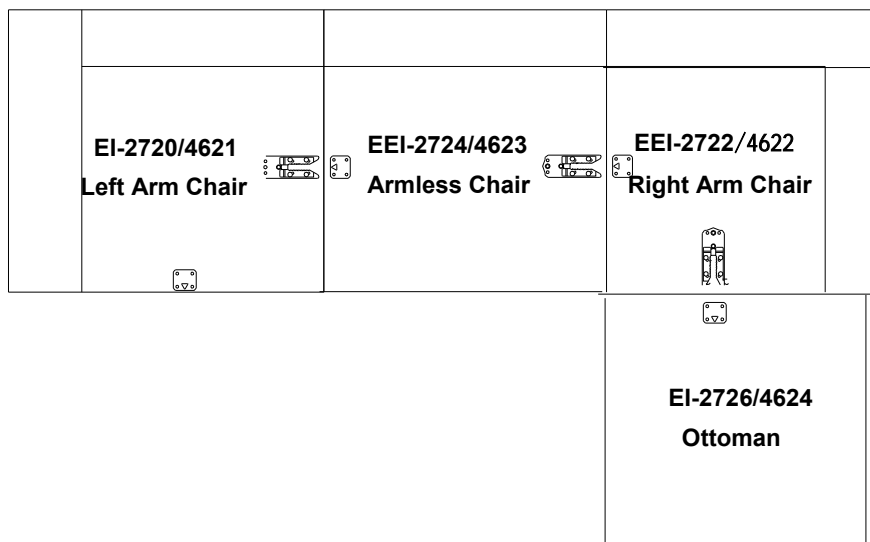
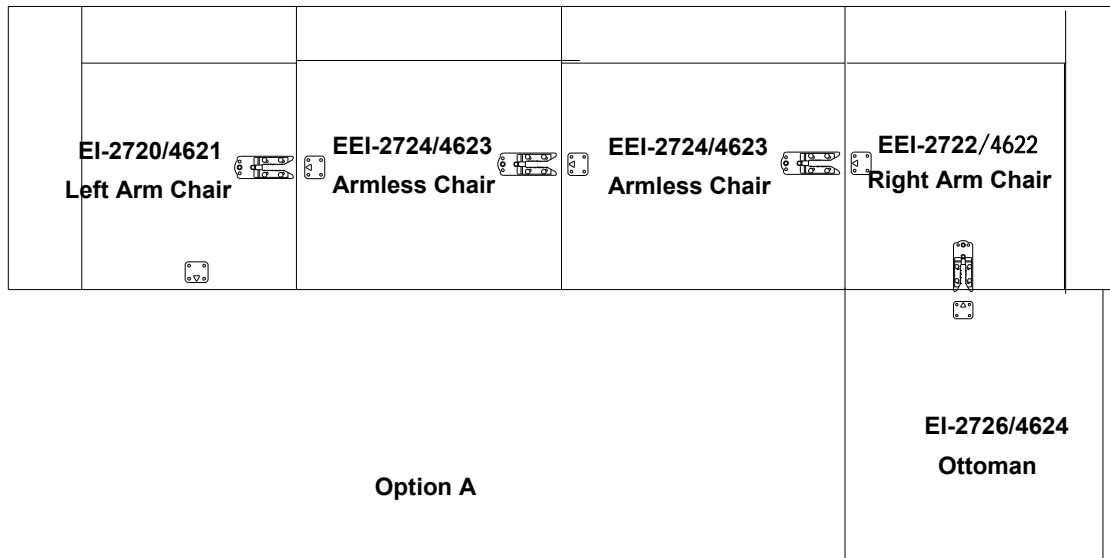

How to connect sofa sectional for EEI-2720/ EEI-4621&EEI-2722/ EEI-4622 & EEI-2724/ EEI-4623& EEI-2726/ EEI-4624& EEI-2728/ EEI-4625



Thank you for purchasing the **MODWAY SOFA!**

Before you start, here is some helpful advice:

1. We suggest you spend a short time reading through this leaflet and then follow the simple step-by-step instructions.
2. Owing to the size and weight of the sofa section, we recommend that it is assembled by two adults, on a carpeted or padded area, in the room that it is intended for. Approximate assembly time: 30 minutes.
3. Please do not use any tools other than those provided or recommended in these instructions.
4. Please do not throw away any of the packaging or instructions until you have checked all the components and hardware and the furniture is fully assembled.
5. Assemble all components loosely until advised to tighten. Depending on use, it may be necessary to tighten the components from time to time, so please save the tools that have been provided.
6. Please keep all pieces out of reach of children.

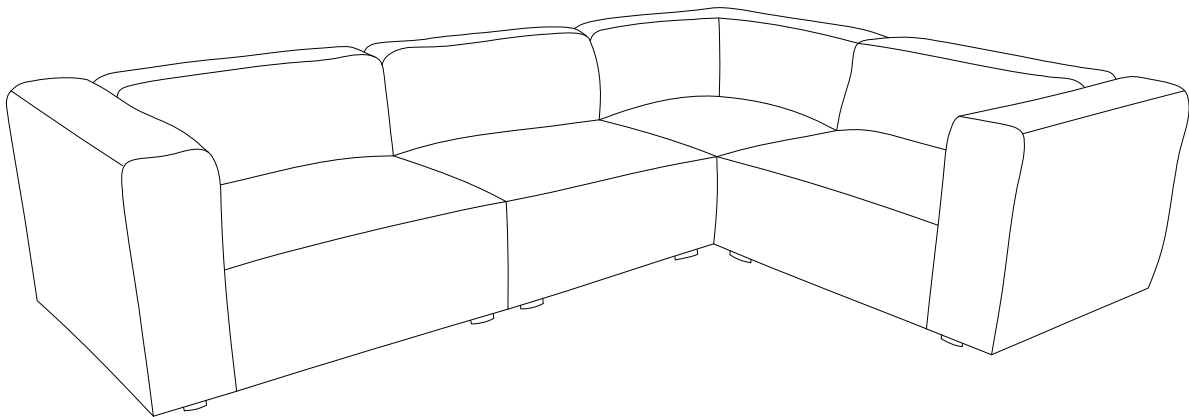

Component:

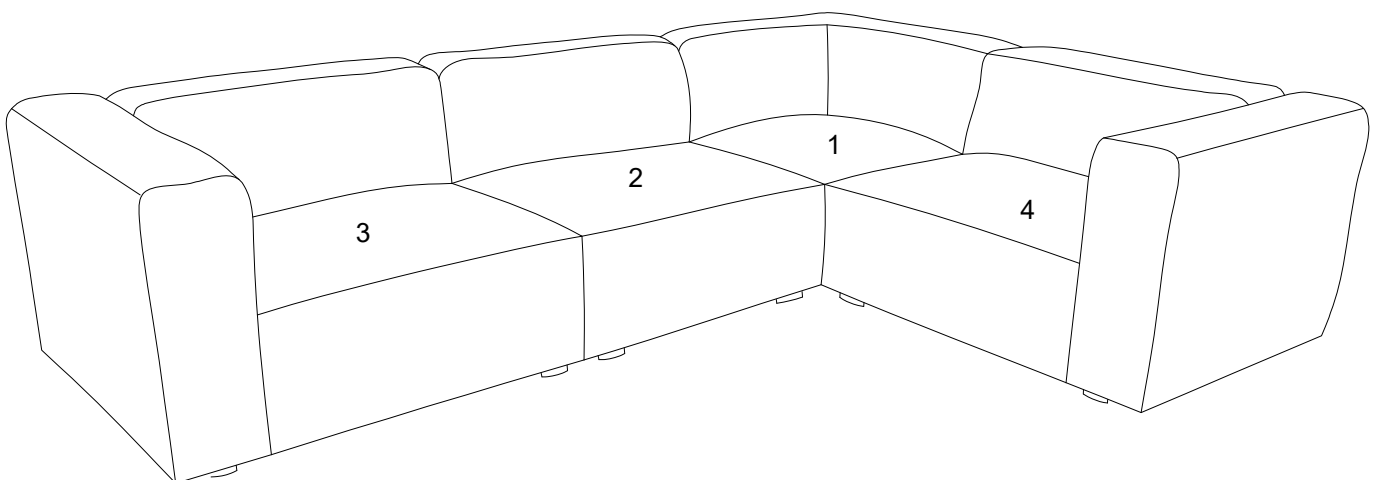

1 EEI-2728/EEI-4625 Corner Seat x1

2 EEI-2724/ EEI-4623 Armless Chair x1

3 EEI-2720/ EEI-4621 Left Arm Chair x1

4 EEI-2722/ EEI-4622 Right Arm Chair x1

STEP 1:

Please carefully place **EEI-2728/4625 Corner Seat (1)** at you desired location.

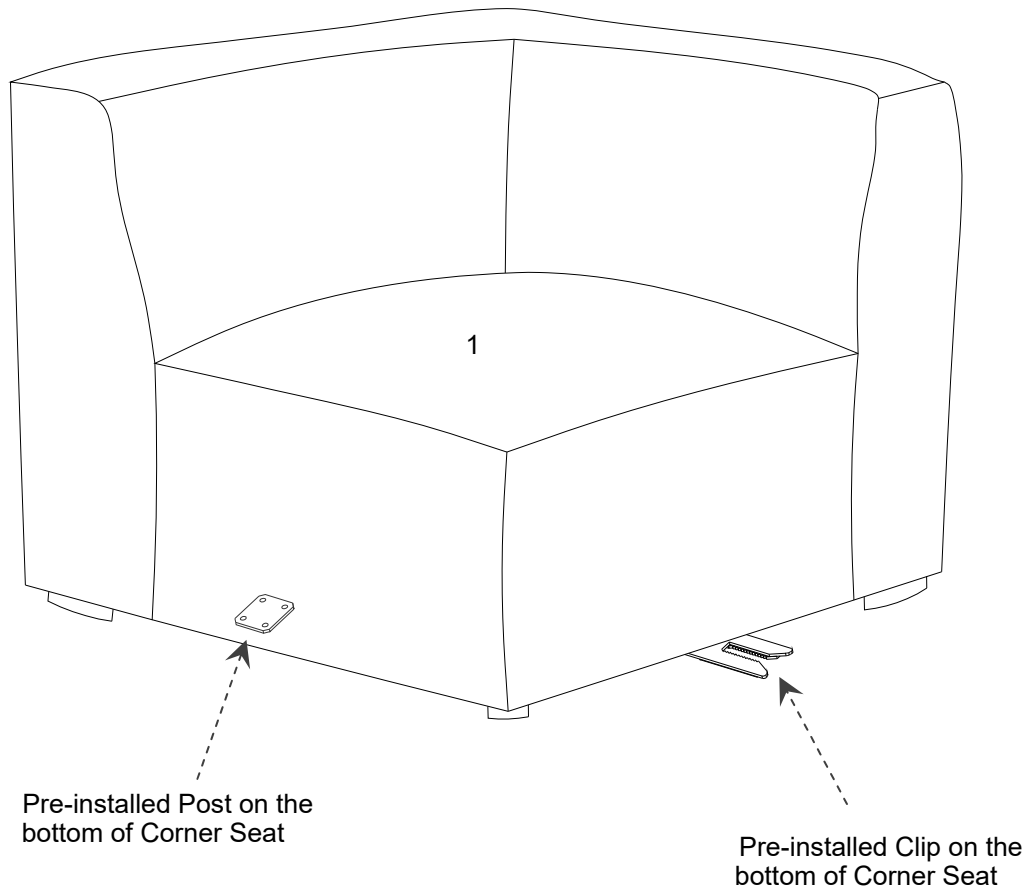

STEP 2:

Put **EEI-2722/4622 Right Arm Chair (4)** and **EEI-2724/4623 Armless Chair(2)** close to **EEI-2728/4625 Corner Seat (1)**. Align the pre-installed Clip to the pre-installed Post as shown.

Push **EEI-2722/4622 Right Arm Chair (4)** and **EEI-2724/4623 Armless Chair (2)** slowly until the Clip and the Post click together tightly.

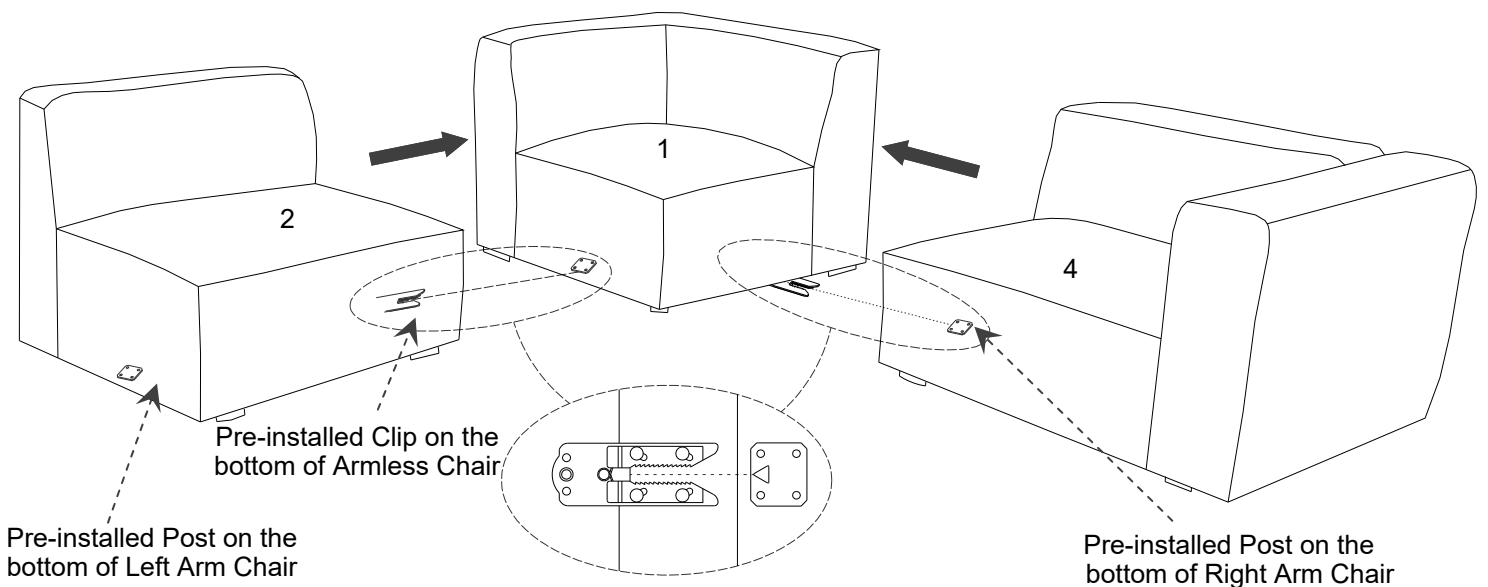

How to connect sofa sectional for EEI-2720/ EEI-4621&EEI-2722/ EEI-4622 & EEI-2724/ EEI-4623& EEI-2726/ EEI-4624& EEI-2728/ EEI-4625

STEP 3:

Put **EEI-2720/4621 Left Arm Chair (3)** close to **EEI-2724/4623 Armless Chair (2)**.

Align the pre-installed Clip to the pre-installed Post as shown.

Push **EEI-2720/4621 Left Arm Chair (3)** slowly until the Clip and the Post click together tightly.

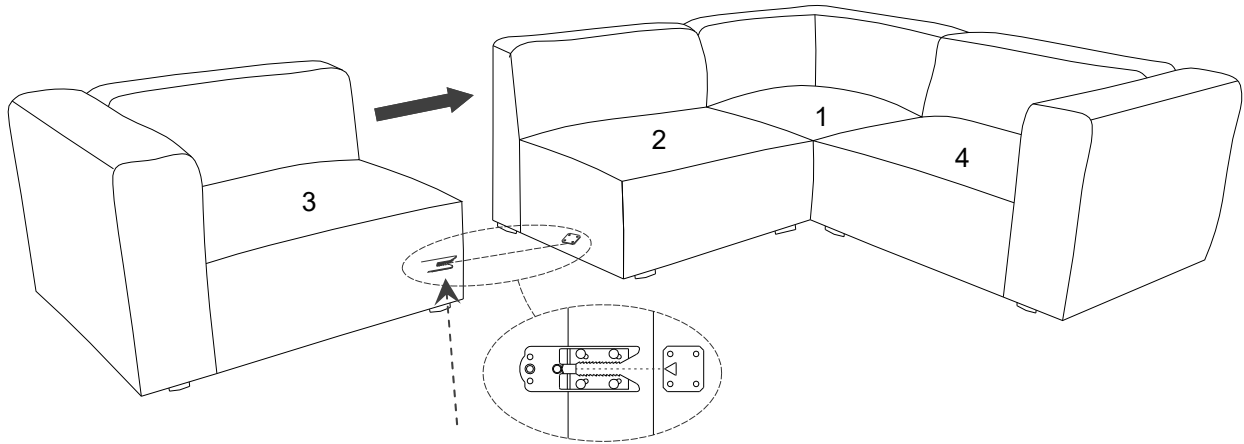

Pre-installed Clip on the bottom of Left Arm Chair

Assembly is complete. Your sofa combination is ready to be used now!

If you want to unlock the sofa combination.

Lift up **EEI-2724/4623 Armless Chair (2)** and move **EEI-2720/4621 Left Arm Chair (3)** apart to **EEI-2724/4623 Armless Chair (2)**.

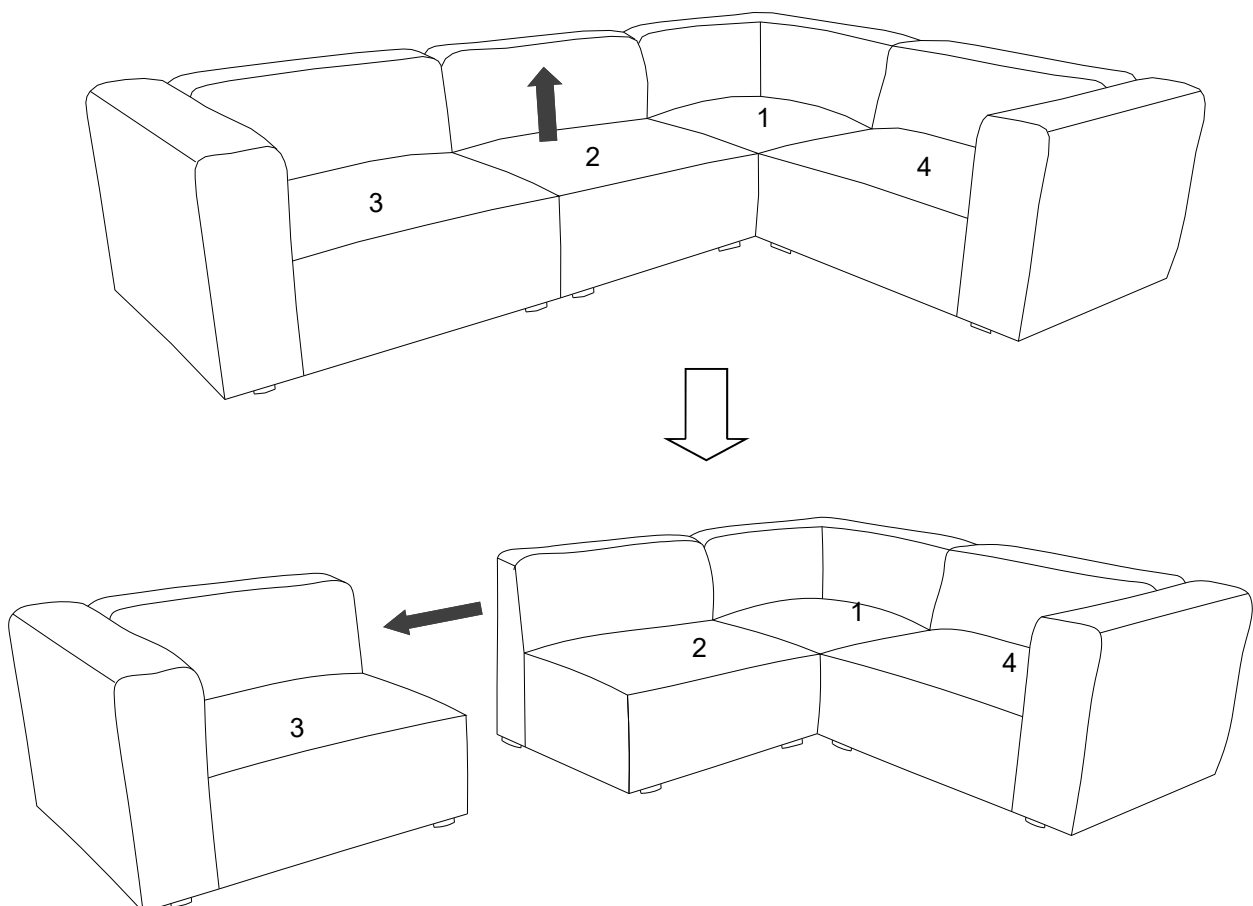

**How to connect sofa sectional for EEI-2720/ EEI-4621&EEI-2722/ EEI-4622
& EEI-2724/ EEI-4623& EEI-2726/ EEI-4624& EEI-2728/ EEI-4625**



Lift up **EEI-2728/4625 Corner Seat (1)** and move **EEI-2724/4623 Armless Chair (2)** apart to **EEI-2728/4625 Corner Seat (1)** as shown.

Lift up **EEI-2722/4622 Right Arm Chair (4)** and move **EEI-2722/4622 Right Arm Chair (4)** apart to **EEI-2728/4625 Corner Seat (1)**.

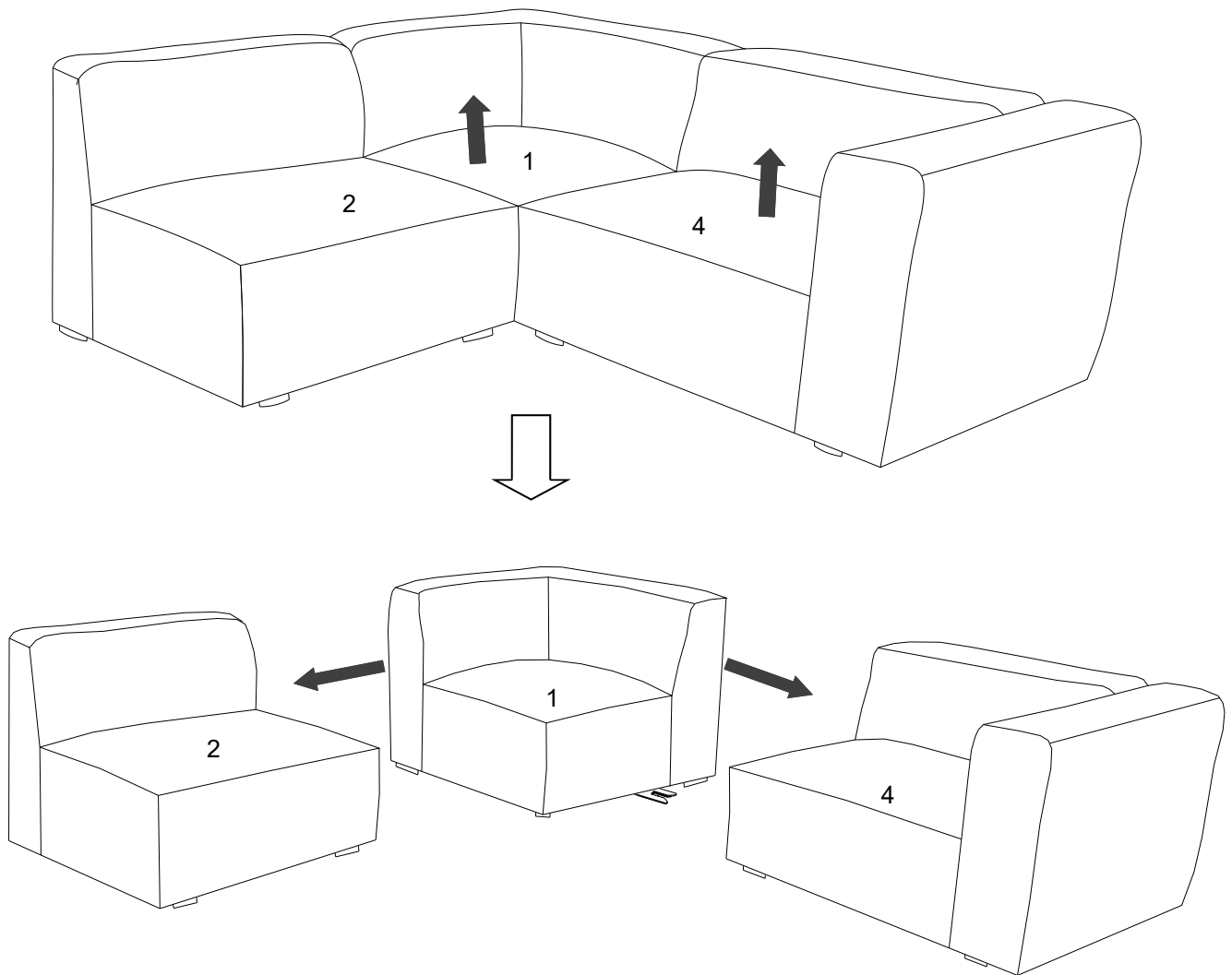

ASSEMBLY FOR EEI-2726/ EEI-4624 OTTOMAN

Please find the extra hardware from **EEI-2726/4624 Ottoman** carton.

Put **EEI-2726/4624 Ottoman** upside down on a carpeted or padded area.





Place the required Post/Clip to the pre-marked position on the bottom of **EEI-2726/4624 Ottoman** as shown.

Insert the **Screws** to the bottom of **EEI-2726/4624 Ottoman** through **Clip/Post** as shown.

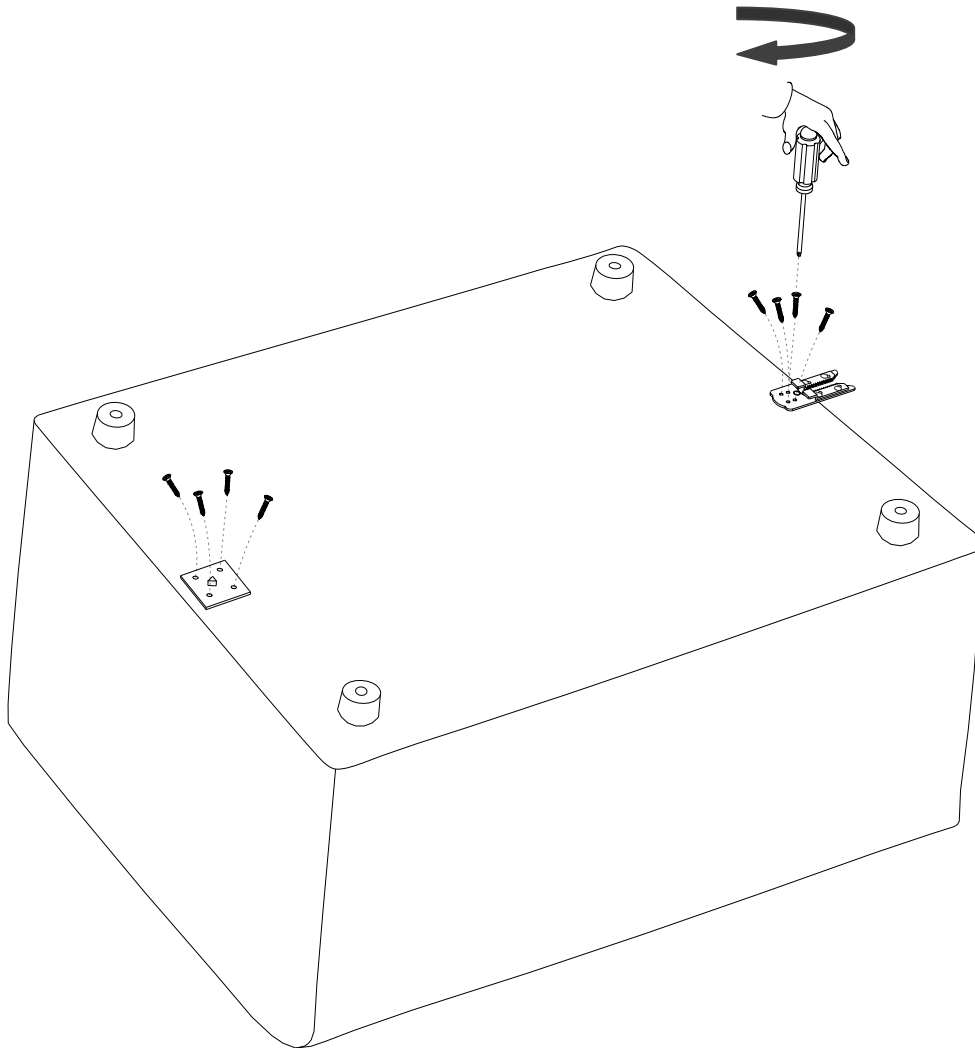
Use **Phillips Head Screwdriver (Not provided)** to tighten **Screws** clockwise until secure.

Repeat the same steps to lock the Clip and Post together tightly.



			
Screw x8	Clip x1	Post x1	Phillips Head Screwdriver (not included)

If you want to lock **EEI-2726/4624 Ottoman** to the sofa combination, the assembly instruction is as the following:

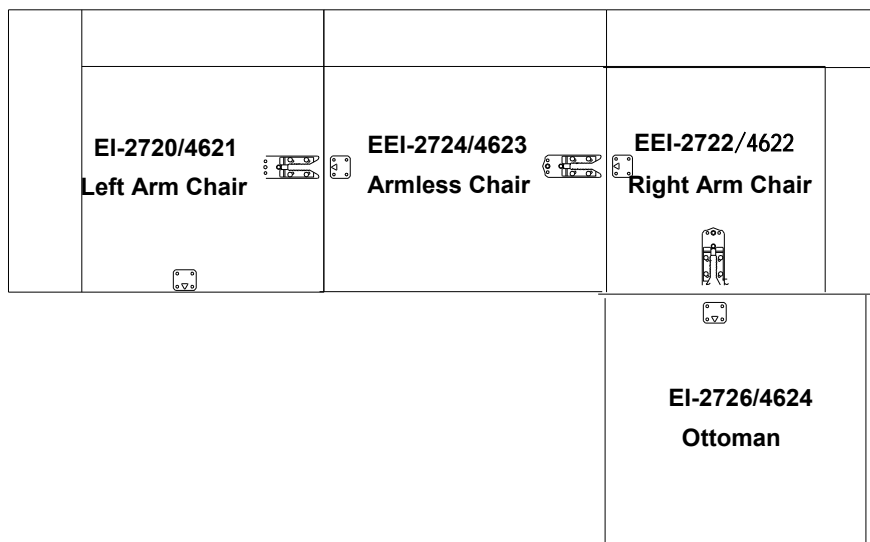
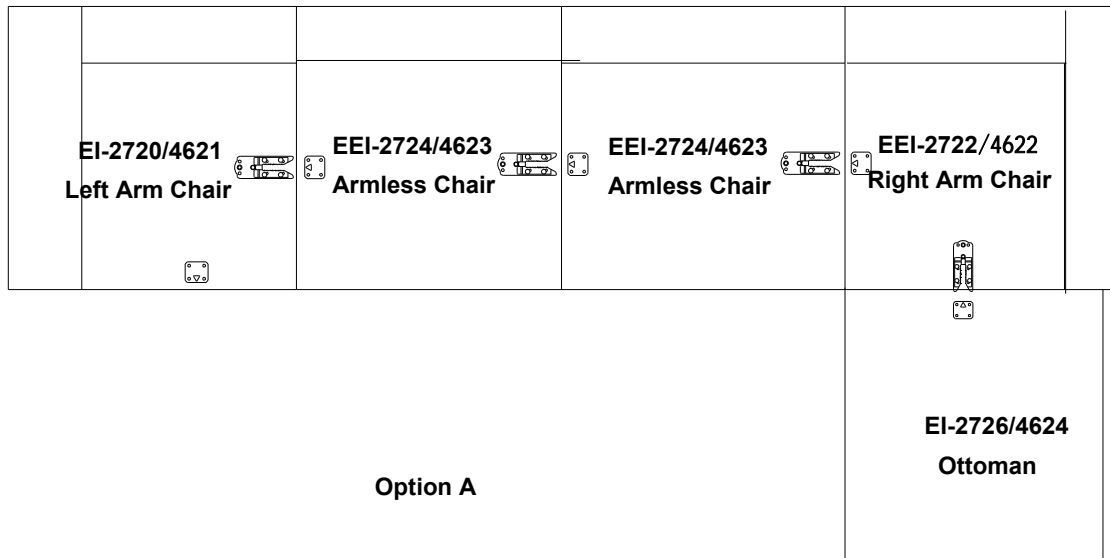

Option B

How to connect sofa sectional for EEI-2720/ EEI-4621&EEI-2722/ EEI-4622 & EEI-2724/ EEI-4623& EEI-2726/ EEI-4624& EEI-2728/ EEI-4625



Thank you for purchasing the **MODWAY SOFA!**

Before you start, here is some helpful advice:

1. We suggest you spend a short time reading through this leaflet and then follow the simple step-by-step instructions.
2. Owing to the size and weight of the sofa section, we recommend that it is assembled by two adults, on a carpeted or padded area, in the room that it is intended for. Approximate assembly time: 30 minutes.
3. Please do not use any tools other than those provided or recommended in these instructions.
4. Please do not throw away any of the packaging or instructions until you have checked all the components and hardware and the furniture is fully assembled.
5. Assemble all components loosely until advised to tighten. Depending on use, it may be necessary to tighten the components from time to time, so please save the tools that have been provided.
6. Please keep all pieces out of reach of children.

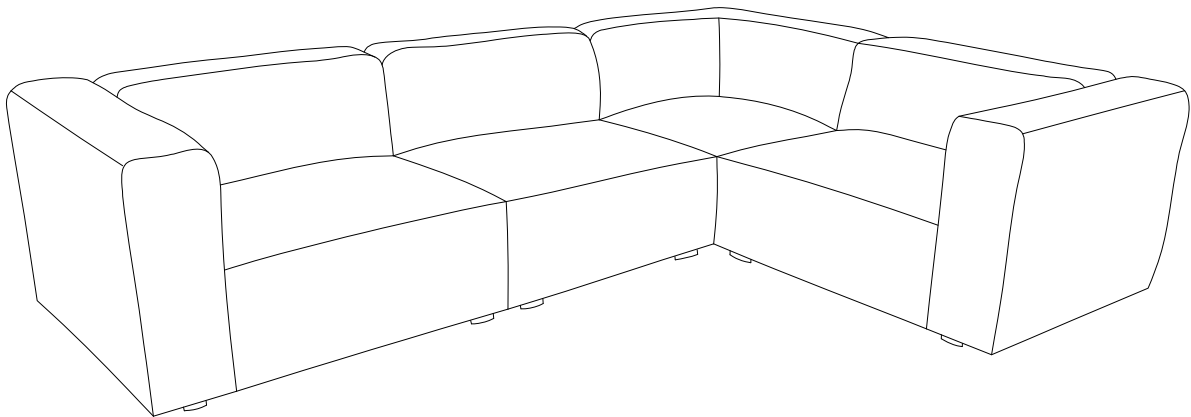

Component:

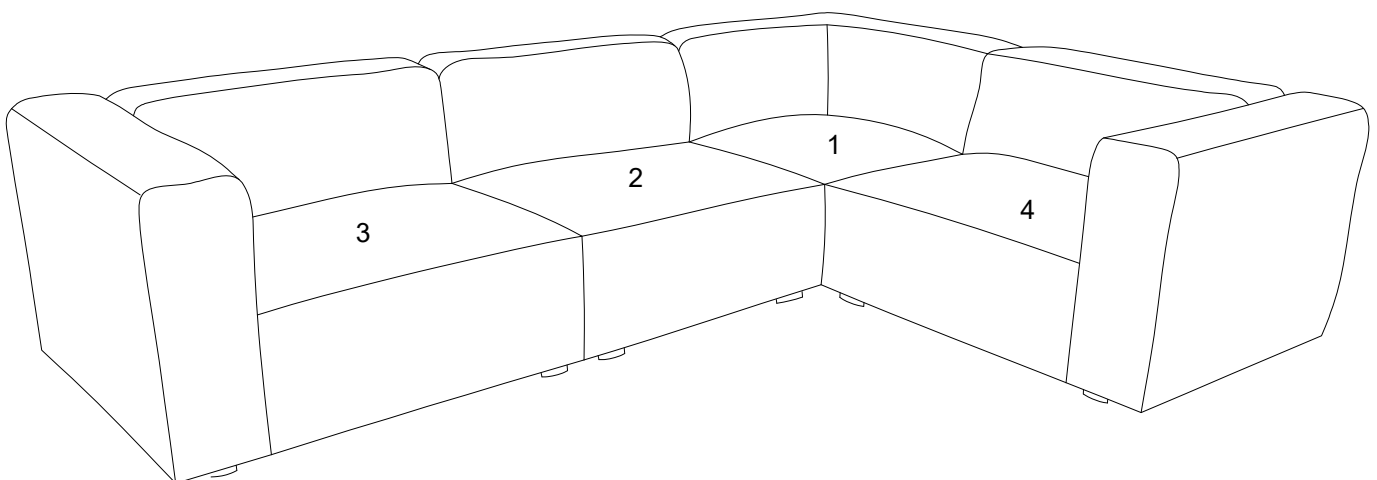

1 EEI-2728/EEI-4625 Corner Seat x1

2 EEI-2724/ EEI-4623 Armless Chair x1

3 EEI-2720/ EEI-4621 Left Arm Chair x1

4 EEI-2722/ EEI-4622 Right Arm Chair x1

STEP 1:

Please carefully place **EEI-2728/4625 Corner Seat (1)** at you desired location.

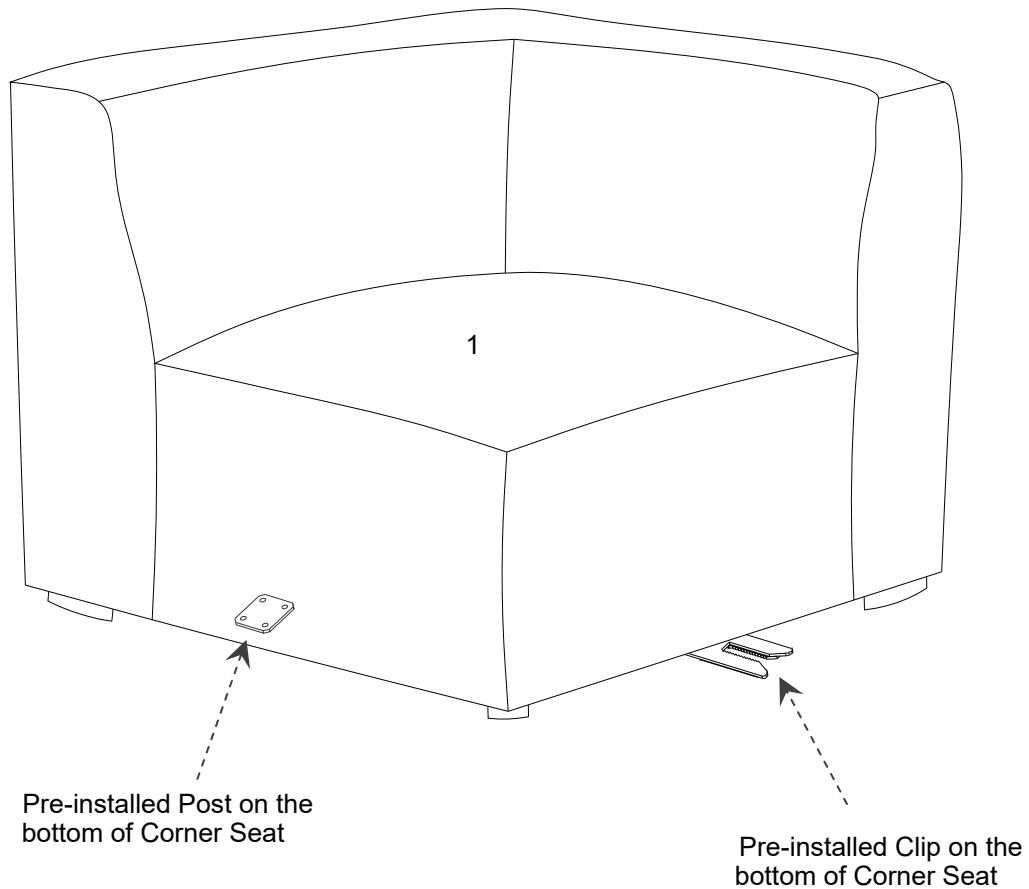

STEP 2:

Put **EEI-2722/4622 Right Arm Chair (4)** and **EEI-2724/4623 Armless Chair(2)** close to **EEI-2728/4625 Corner Seat (1)**. Align the pre-installed Clip to the pre-installed Post as shown.

Push **EEI-2722/4622 Right Arm Chair (4)** and **EEI-2724/4623 Armless Chair (2)** slowly until the Clip and the Post click together tightly.

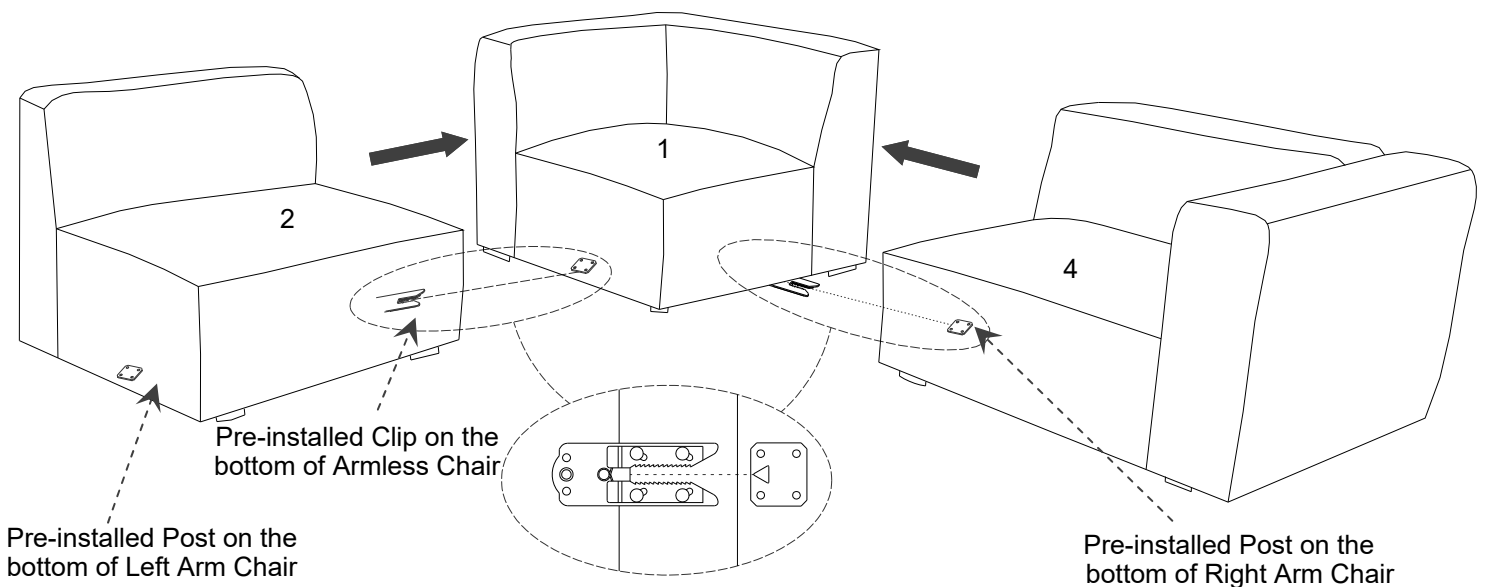

**How to connect sofa sectional for EEI-2720/ EEI-4621&EEI-2722/ EEI-4622
& EEI-2724/ EEI-4623& EEI-2726/ EEI-4624& EEI-2728/ EEI-4625**

STEP 3:

Put **EEI-2720/4621 Left Arm Chair (3)** close to **EEI-2724/4623 Armless Chair (2)**.

Align the pre-installed Clip to the pre-installed Post as shown.

Push **EEI-2720/4621 Left Arm Chair (3)** slowly until the Clip and the Post click together tightly.

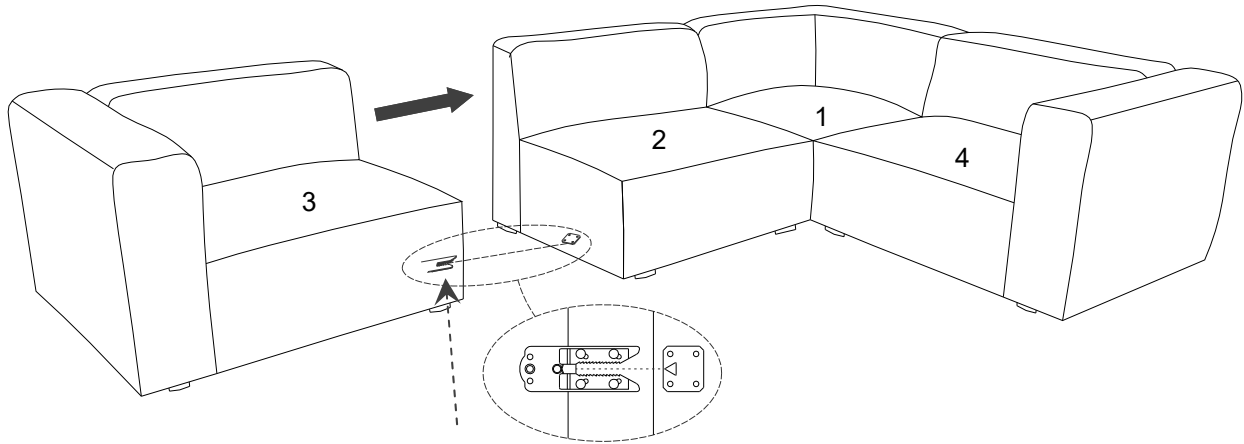

Pre-installed Clip on the bottom of Left Arm Chair

Assembly is complete. Your sofa combination is ready to be used now!

If you want to unlock the sofa combination.

Lift up **EEI-2724/4623 Armless Chair (2)** and move **EEI-2720/4621 Left Arm Chair (3)** apart to **EEI-2724/4623 Armless Chair (2)**.

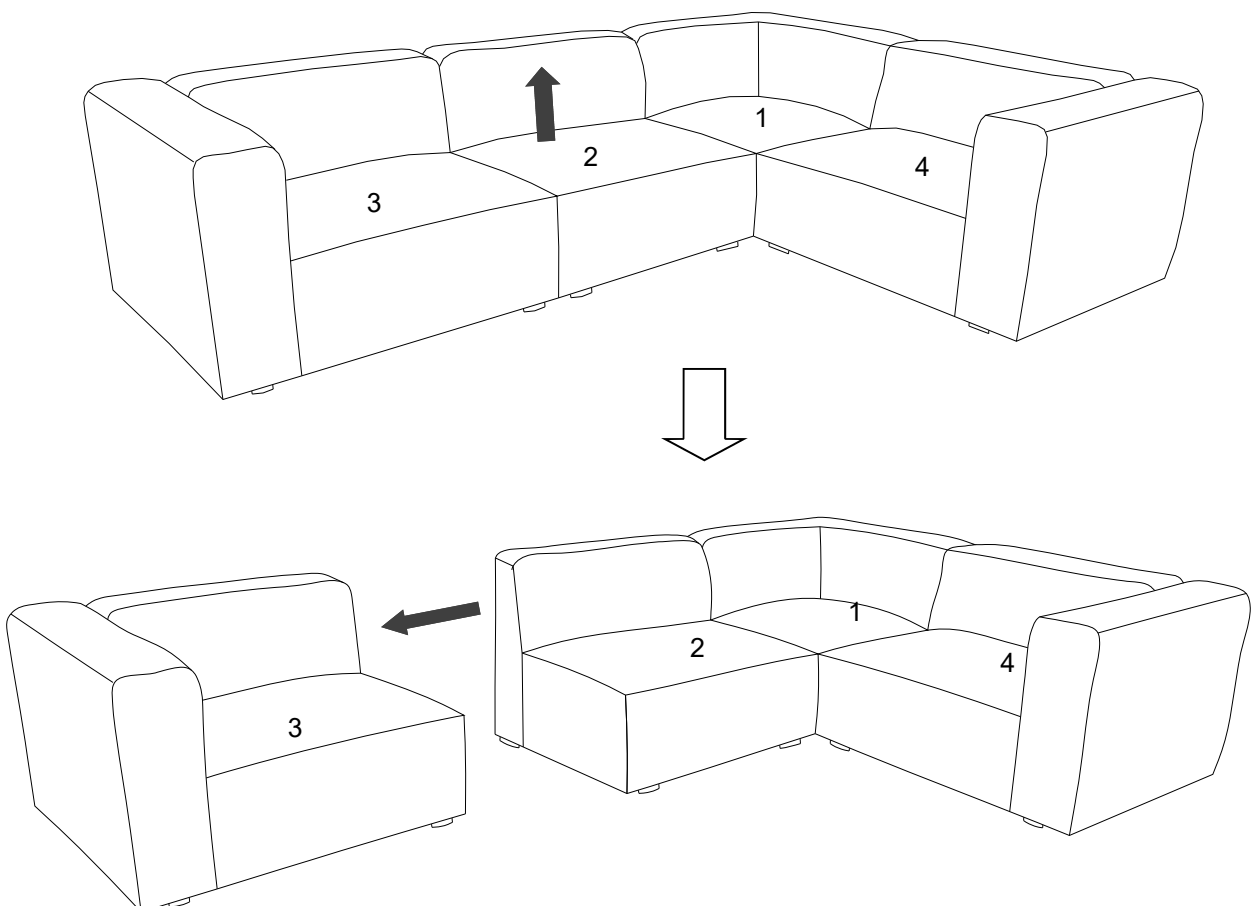

**How to connect sofa sectional for EEI-2720/ EEI-4621&EEI-2722/ EEI-4622
& EEI-2724/ EEI-4623& EEI-2726/ EEI-4624& EEI-2728/ EEI-4625**



Lift up **EEI-2728/4625 Corner Seat (1)** and move **EEI-2724/4623 Armless Chair (2)** apart to **EEI-2728/4625 Corner Seat (1)** as shown.

Lift up **EEI-2722/4622 Right Arm Chair (4)** and move **EEI-2722/4622 Right Arm Chair (4)** apart to **EEI-2728/4625 Corner Seat (1)**.

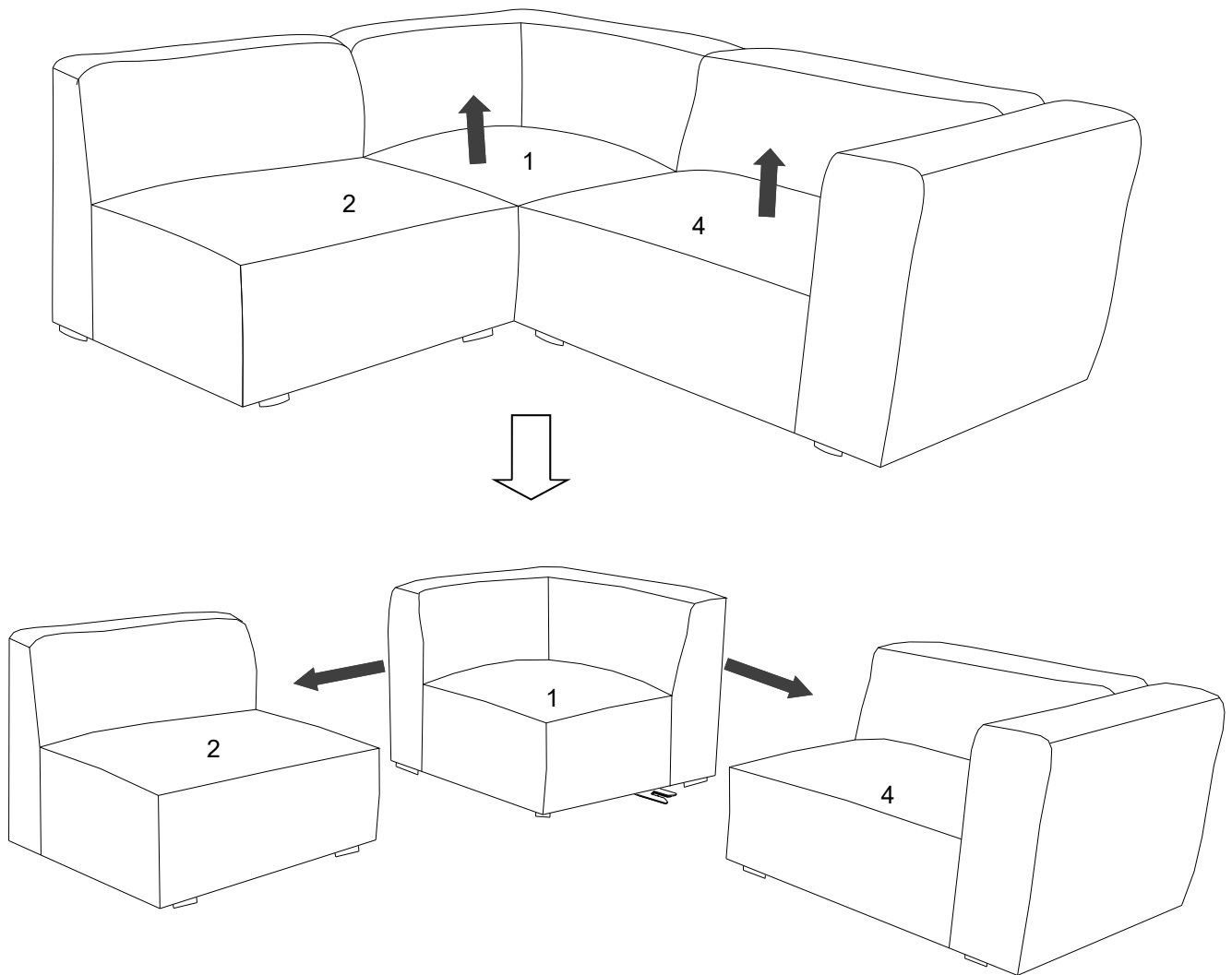

ASSEMBLY FOR EEI-2726/ EEI-4624 OTTOMAN

Please find the extra hardware from **EEI-2726/4624 Ottoman** carton.

Put **EEI-2726/4624 Ottoman** upside down on a carpeted or padded area.





Place the required Post/Clip to the pre-marked position on the bottom of **EEI-2726/4624 Ottoman** as shown.

Insert the **Screws** to the bottom of **EEI-2726/4624 Ottoman** through **Clip/Post** as shown.

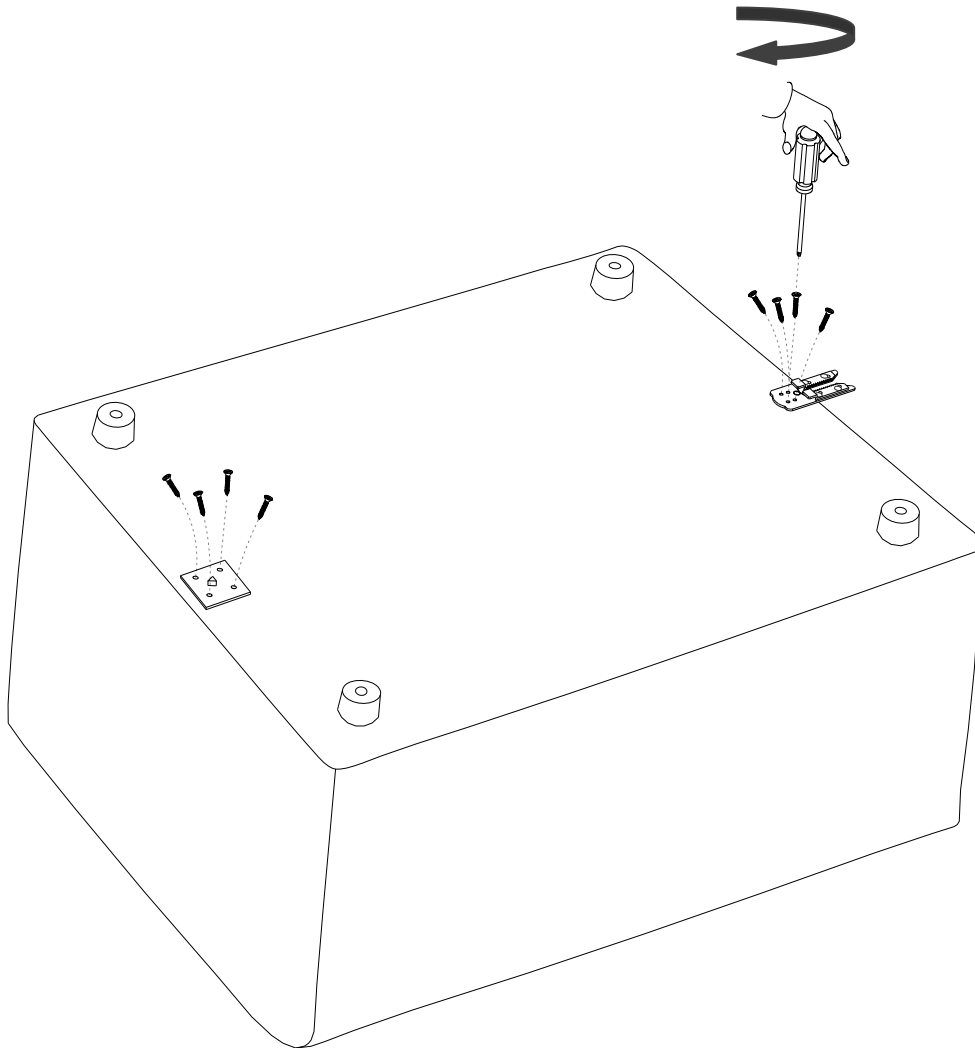
Use **Phillips Head Screwdriver (Not provided)** to tighten **Screws** clockwise until secure.

Repeat the same steps to lock the Clip and Post together tightly.



			
Screw x8	Clip x1	Post x1	Phillips Head Screwdriver (not included)

If you want to lock **EEI-2726/4624 Ottoman** to the sofa combination, the assembly instruction is as the following:

