

Thank you for purchasing the **MODWAY CORNER/ CHAIR/ OTTOMAN**

Before you start, here are some helpful advice:

1. We suggest you spend a short time reading through this leaflet and then follow the simple step-by-step instructions.
2. Owing to the size and weight of the sofa section, we recommend that it is assembled by two adults, on a carpeted or padded area, in the room that it is intended for. Approximate assembly time: 30 minutes.
3. Please do not use any tools other than those provided or recommended in these instructions.
4. Please do not throw away any of the packaging or the instruction until you have checked all the components and hardware and the furniture is fully assembled. Please ensure that the packaging is disposed of in a safe and environmentally friendly way.
5. Assemble all components loosely until advised to tighten. Depending on use, it may be necessary to tighten the components from time to time, so please save the tools that have been provided.
6. Please keep all pieces out of reach of children.

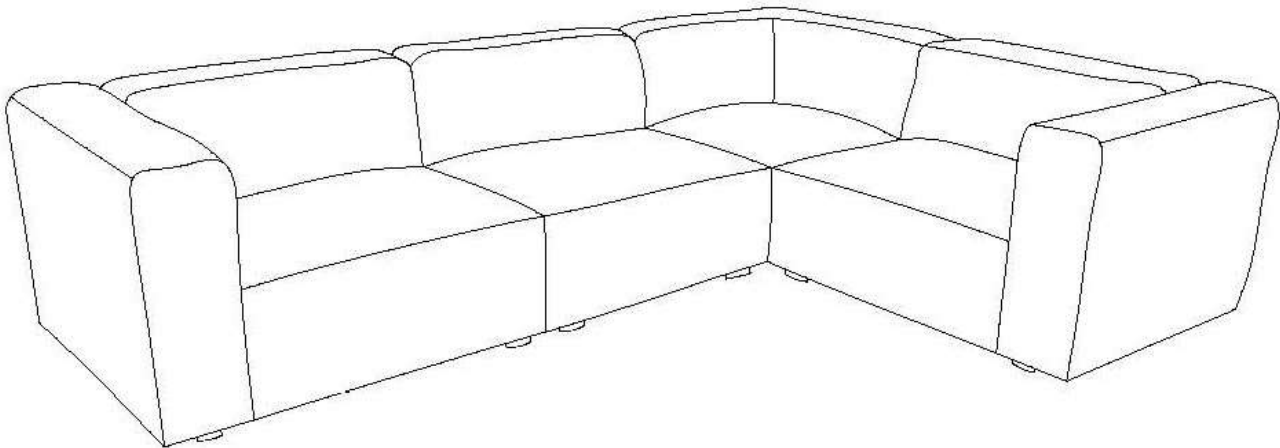

Components:

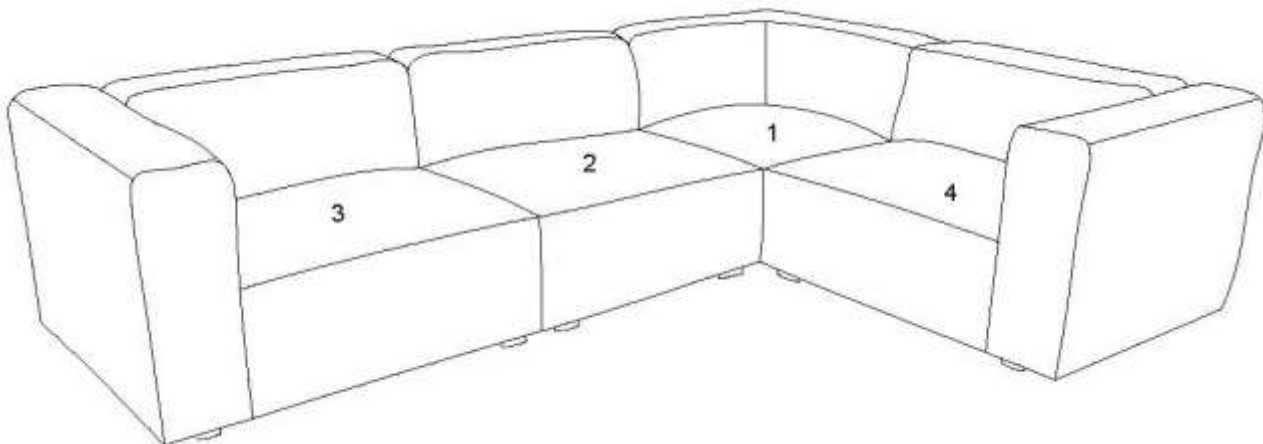

- | | | | |
|---------------------------------------|----|--|----|
| 1. E EI-4402/E EI-4403 Corner | x1 | 2. E EI-4398/E EI-4399 Armless Chair | x1 |
| 3. E EI-4396/E EI-4397 Left Arm Chair | x1 | 4. E EI-4394/E EI-4395 Right Arm Chair | x1 |

STEP 1:

Please carefully place **EEI-4402/4403 Corner (1)** at your desired location.

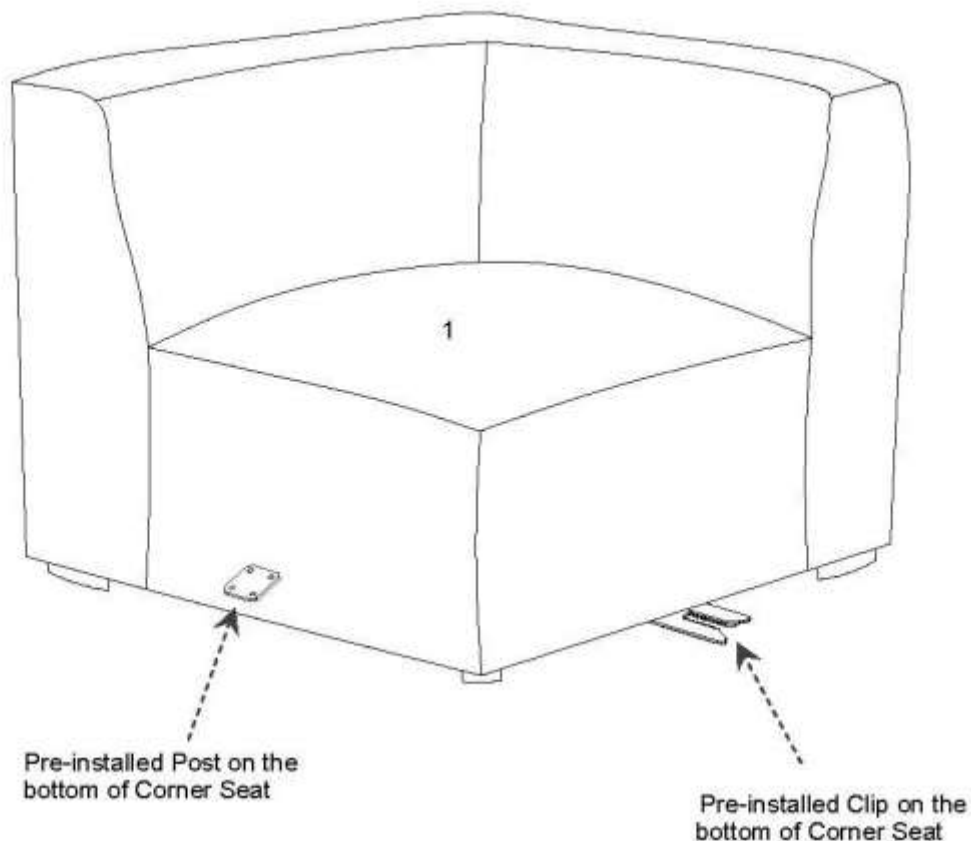

STEP 2:

1. Put **EEI-4398/4399 Armless Chair (2)** and **EEI-4394/4395 Right Arm Chair (4)** close to **EEI-4402/4403 Corner (1)**.
2. Align the pre-installed Clip to the pre-installed Post as shown.
3. Push **EEI-4398/4399 Armless Chair (2)** and **EEI-4394/4395 Right Arm Chair (4)** slowly until the Clip and the Post click together tightly.

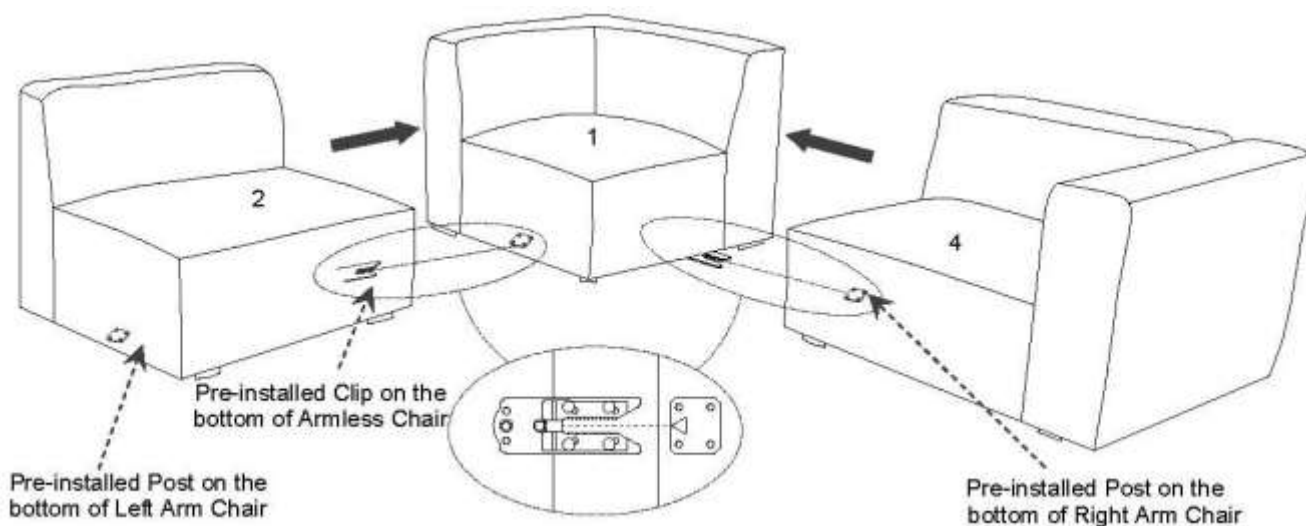

STEP 3:

1. Put **EEI-4396/4397 Left Arm Chair (3)** close to **EEI-4398/4399 Armless Chair (2)**.
2. Align the pre-installed Clip to the pre-installed Post as shown.
3. Push **EEI-4396/4397 Left Arm Chair (3)** slowly until the Clip and the Post click together tightly.

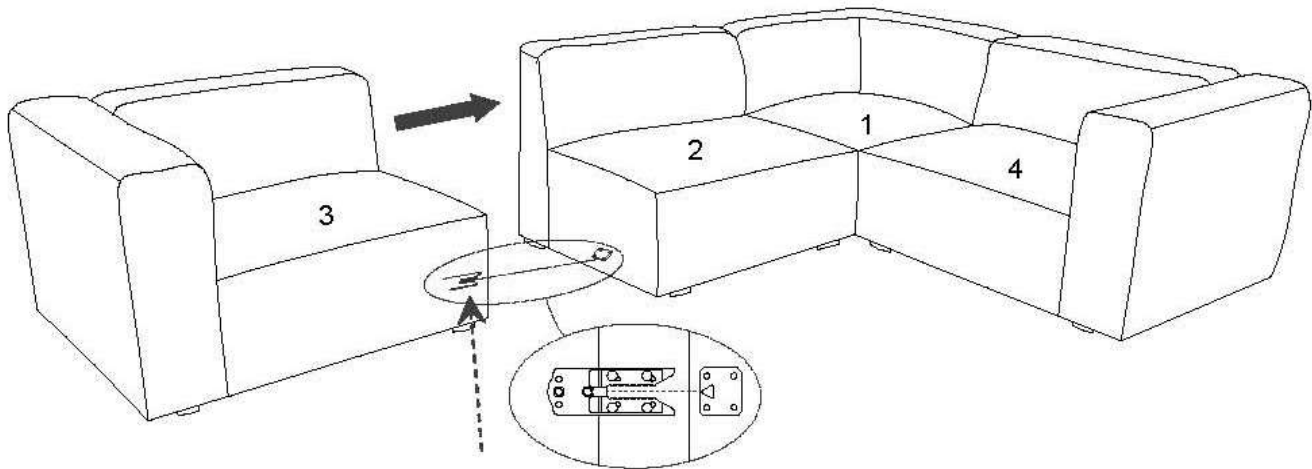

Pre-installed Clip on the
bottom of Left Arm Chair

Assembly is complete. Your sofa combination is ready to be used now!

If you want to unlock the sofa combination:

Lift up **EEI-4398/4399 Armless Chair (2)** and move **EEI-4396/4397 Left Arm Chair (3)** apart from **EEI-4398/4399 Armless Chair (2)**.

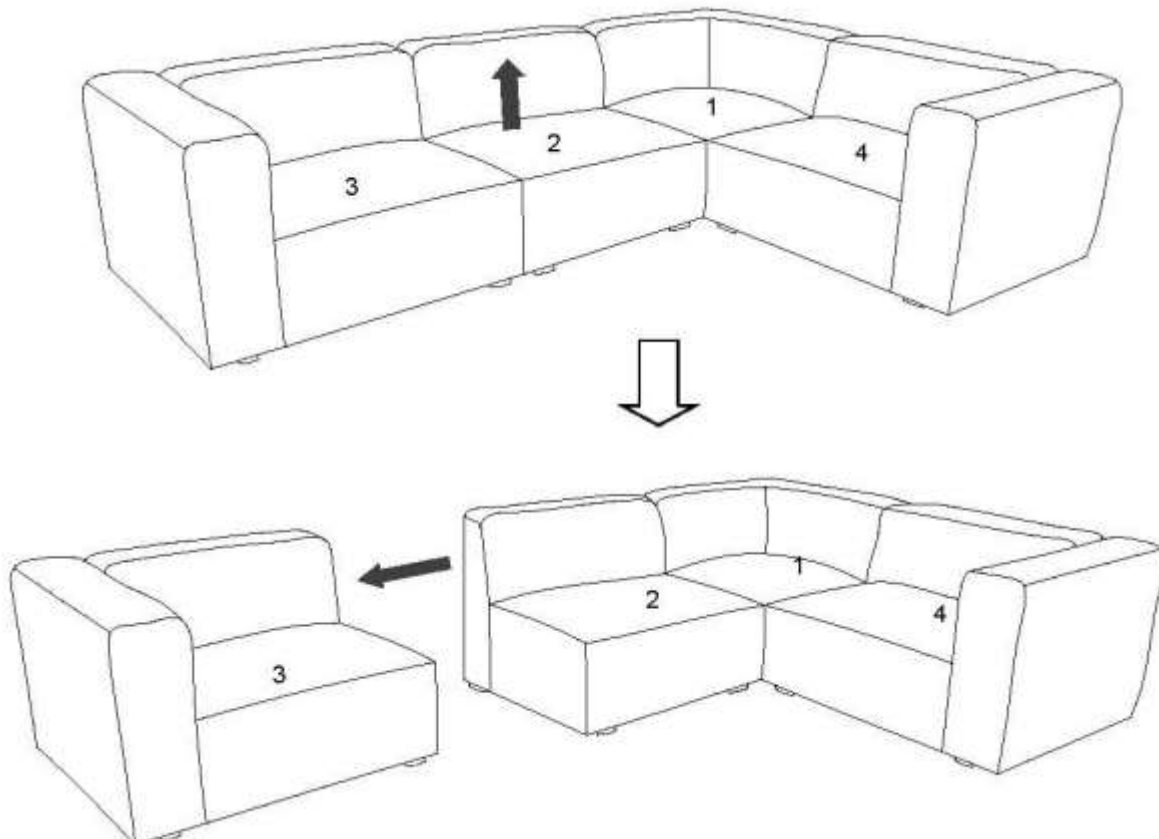

1. Lift up **EEI-4402/4403 Corner (1)** and move **EEI-4398/4399 Armless Chair (2)** apart from **EEI-4402/4403 Corner (1)** as shown.
2. Lift up **EEI-4394/4395 Right Arm Chair (4)** and move **EEI-4394/4395 Right Arm Chair (4)** apart from **EEI-4402/4403 Corner (1)** as shown.

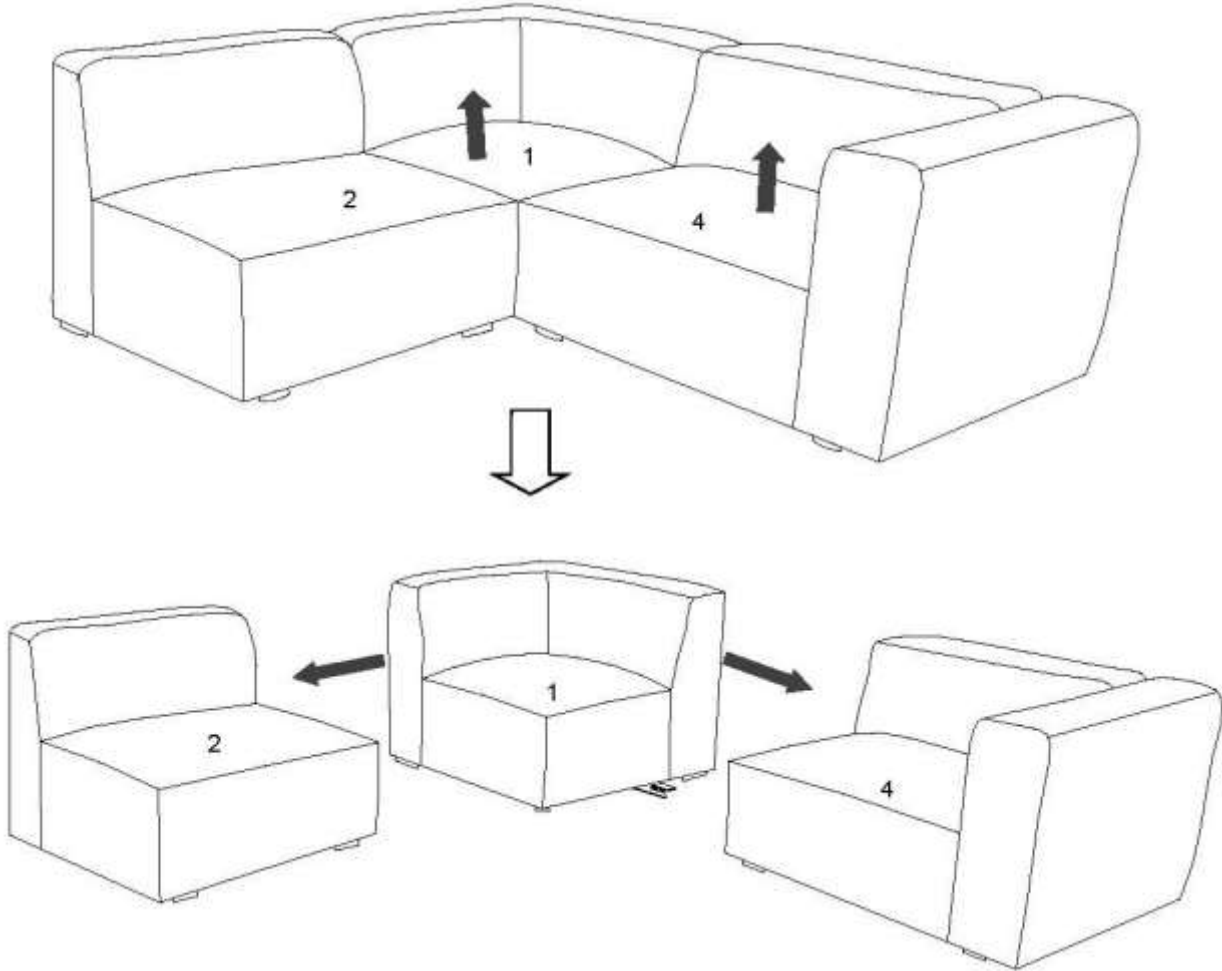

How to connect sofa sectional for

EEI-4394/4395 & EEI-4396/4397 & EEI-4398/4399 & EEI-4400/4401 & EEI-4402/4403

1. Please find the extra hardware from **EEI-4400/4401 Ottoman** carton.
2. Put **EEI-4400/4401 Ottoman** upside down on a carpeted or padded area.
3. If you want to adjust the position of the installed Post/Clip, please use Phillip Head Screwdriver (Not provided)
Tighten all Screws unscrew screw counterclockwise;
4. Take out all Screws and remove Post/Clip;
5. Place the Post/Clip to the pre-marked position on the bottom of **EEI-4400/4401 Ottoman** as shown.
6. Insert the Screws to the bottom of **EEI-4400/4401 Ottoman** through Clip/Post as shown.
7. Use Phillips Head Screwdriver (Not provided) to tighten Screws clockwise until secure.
8. Repeat the same steps to lock the Clip and Post together tightly.

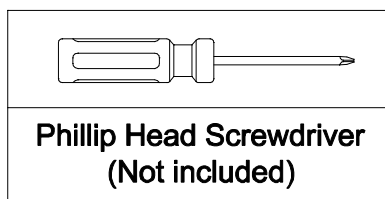
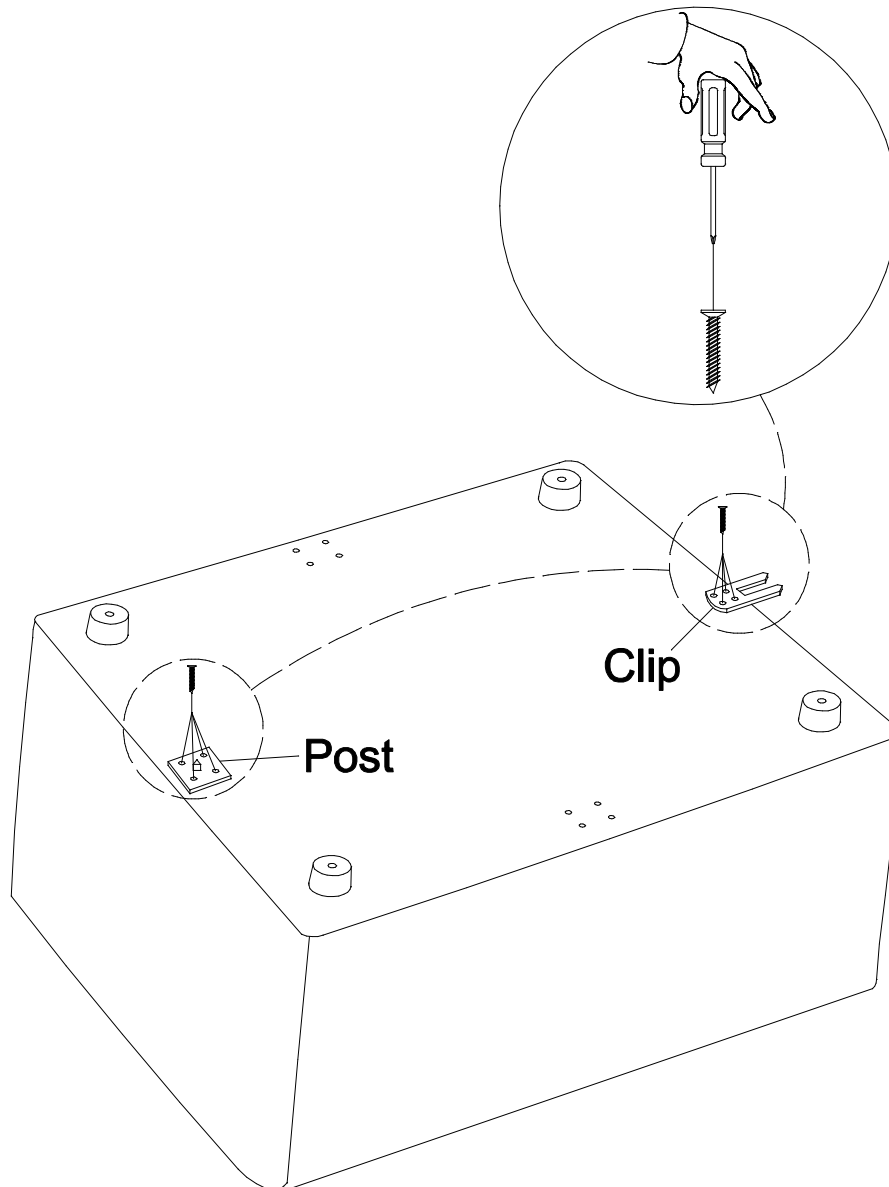

If you want to lock **EEI-4400/4401 Ottoman** to the sofa combination, the assembly instruction is as the following:

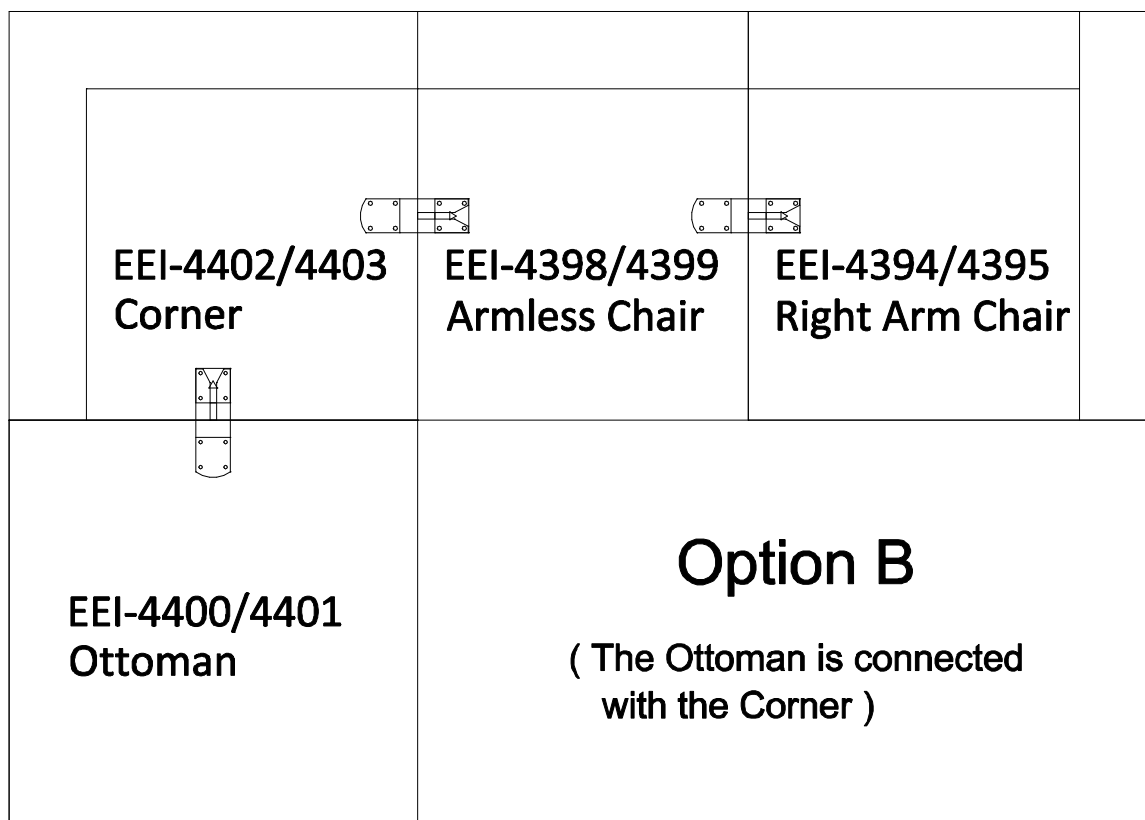
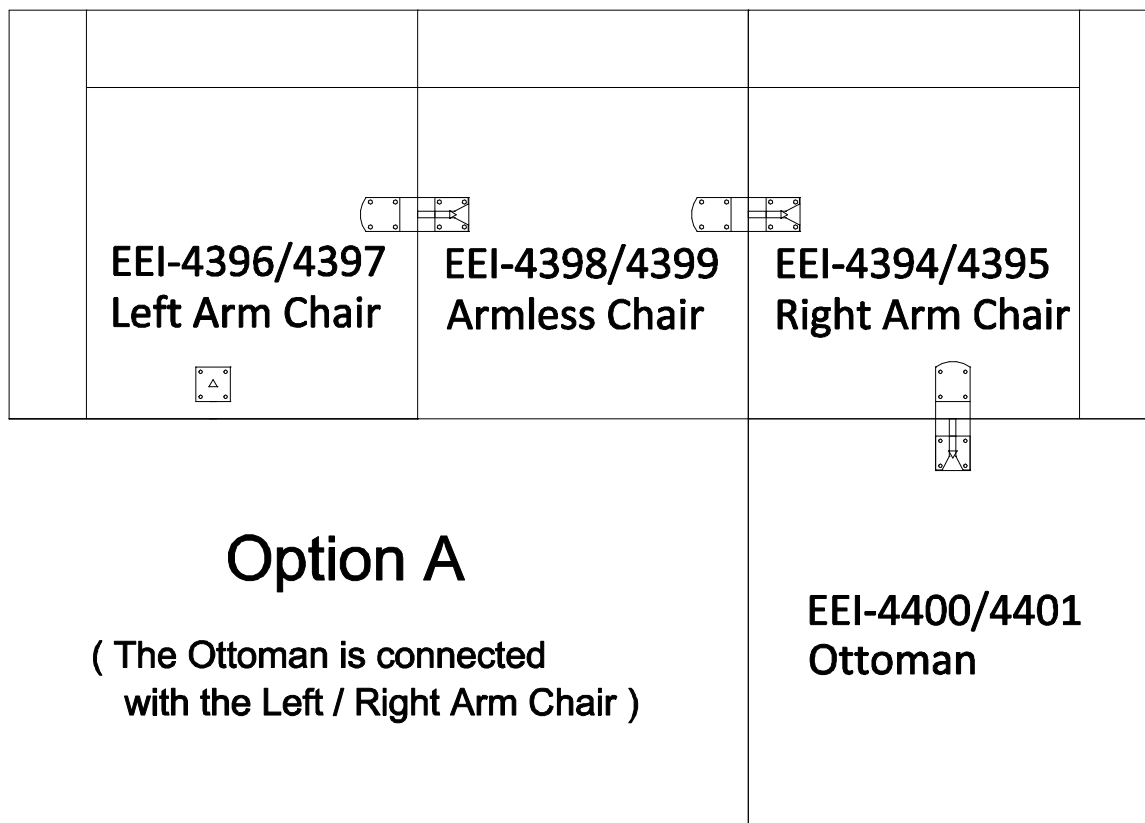

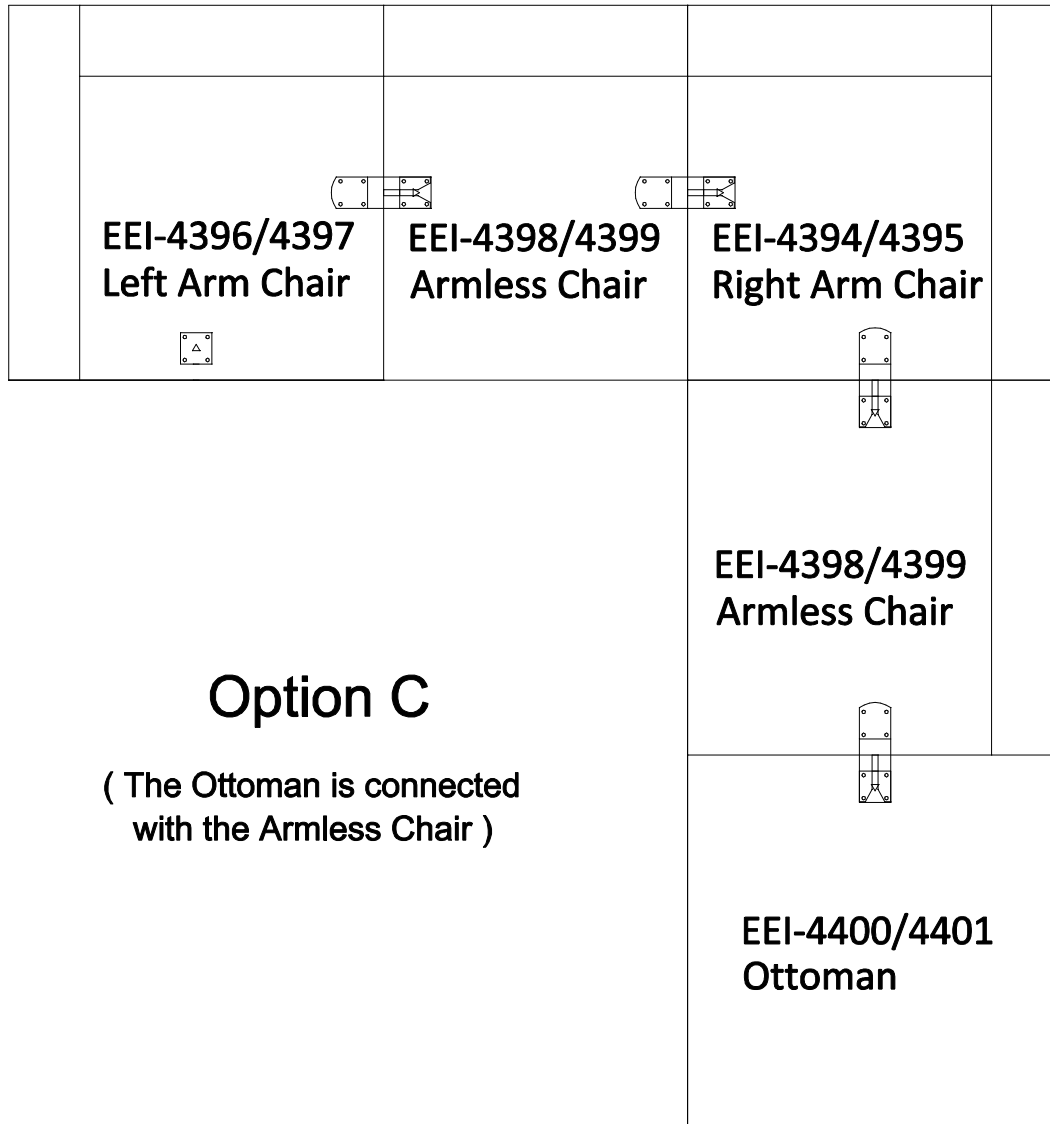

Option C

(The Ottoman is connected
 with the Armless Chair)

Thank you for purchasing the **MODWAY CORNER/ CHAIR/ OTTOMAN**

Before you start, here are some helpful advice:

1. We suggest you spend a short time reading through this leaflet and then follow the simple step-by-step instructions.
2. Owing to the size and weight of the sofa section, we recommend that it is assembled by two adults, on a carpeted or padded area, in the room that it is intended for. Approximate assembly time: 30 minutes.
3. Please do not use any tools other than those provided or recommended in these instructions.
4. Please do not throw away any of the packaging or the instruction until you have checked all the components and hardware and the furniture is fully assembled. Please ensure that the packaging is disposed of in a safe and environmentally friendly way.
5. Assemble all components loosely until advised to tighten. Depending on use, it may be necessary to tighten the components from time to time, so please save the tools that have been provided.
6. Please keep all pieces out of reach of children.

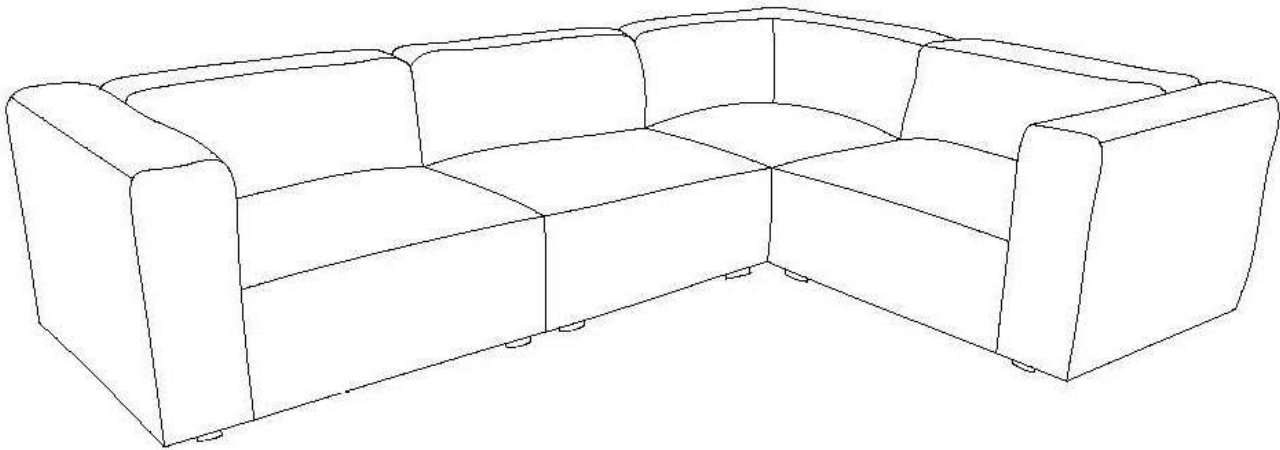

Components:

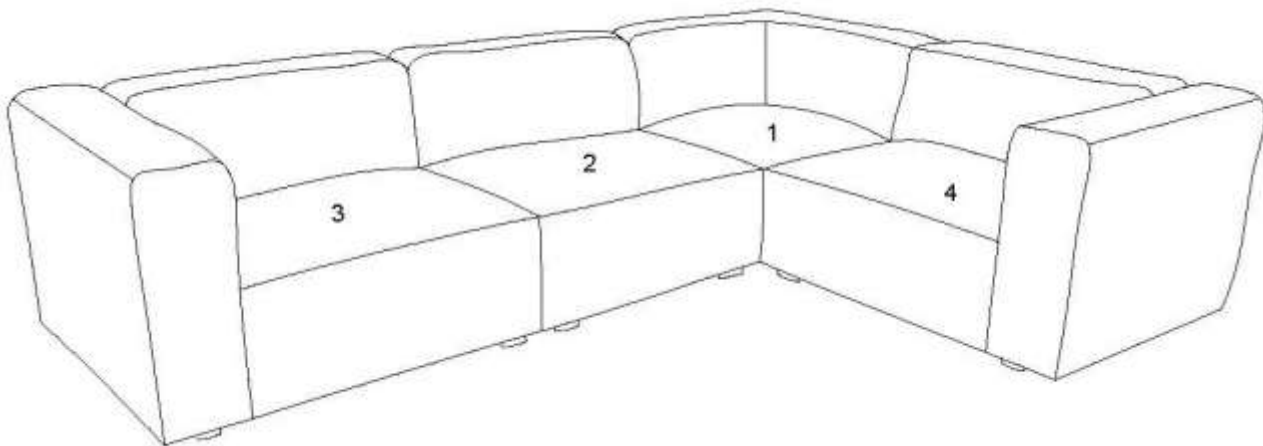

- | | | | |
|---------------------------------------|----|--|----|
| 1. E EI-4402/E EI-4403 Corner | x1 | 2. E EI-4398/E EI-4399 Armless Chair | x1 |
| 3. E EI-4396/E EI-4397 Left Arm Chair | x1 | 4. E EI-4394/E EI-4395 Right Arm Chair | x1 |

STEP 1:

Please carefully place **EEI-4402/4403 Corner (1)** at your desired location.

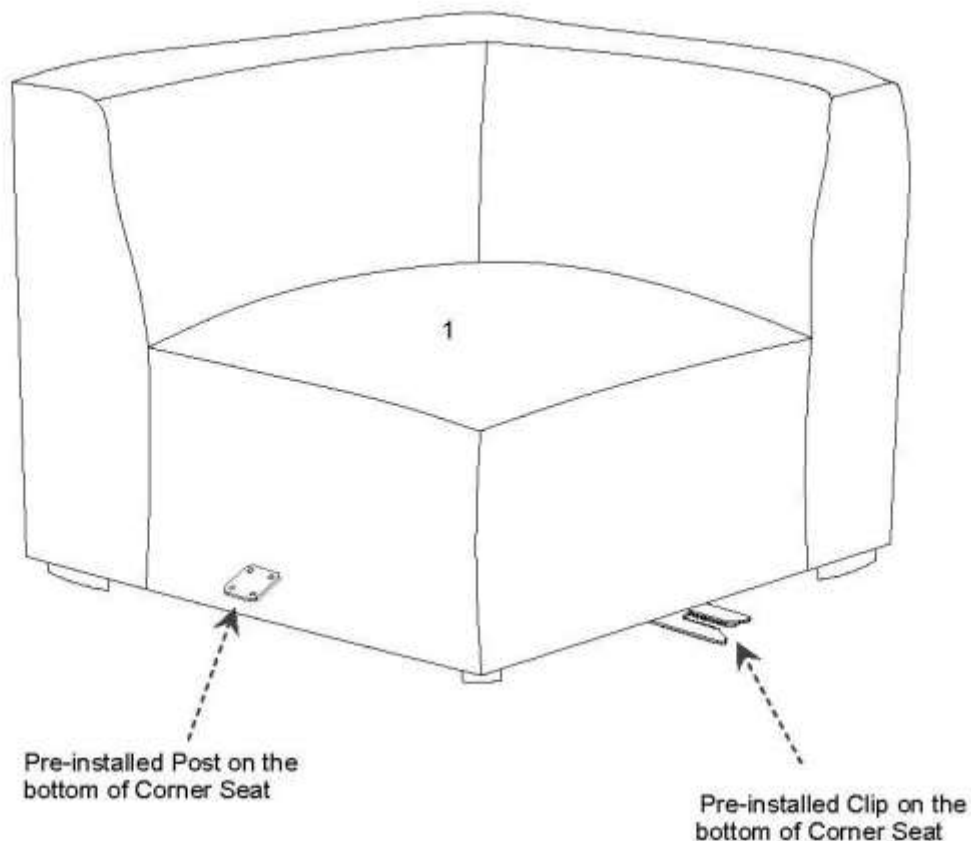

STEP 2:

1. Put **EEI-4398/4399 Armless Chair (2)** and **EEI-4394/4395 Right Arm Chair (4)** close to **EEI-4402/4403 Corner (1)**.
2. Align the pre-installed Clip to the pre-installed Post as shown.
3. Push **EEI-4398/4399 Armless Chair (2)** and **EEI-4394/4395 Right Arm Chair (4)** slowly until the Clip and the Post click together tightly.

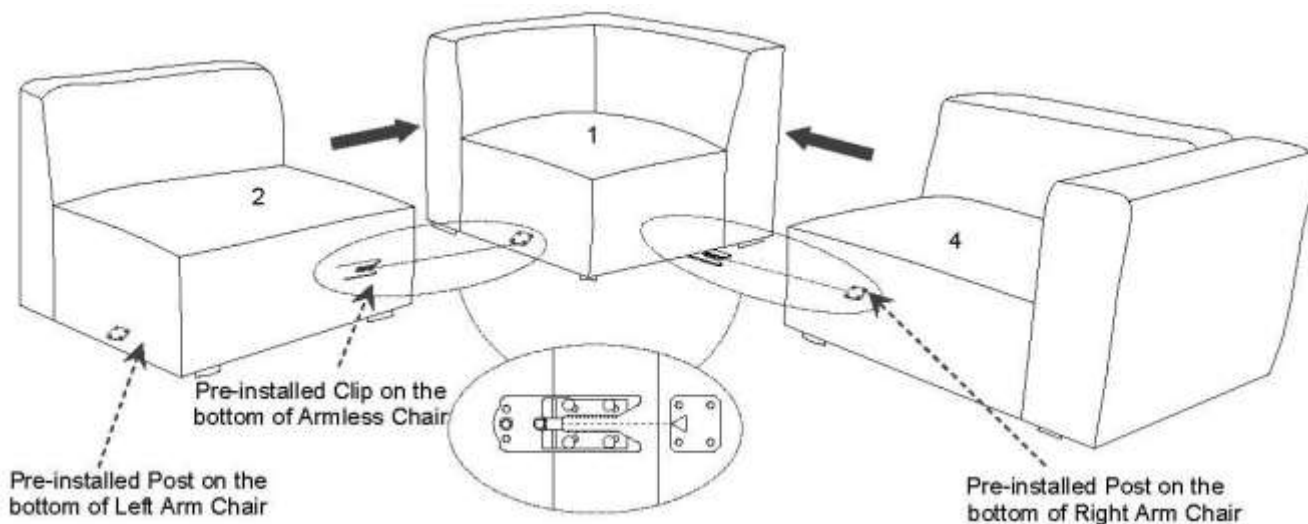

STEP 3:

1. Put **EEI-4396/4397 Left Arm Chair (3)** close to **EEI-4398/4399 Armless Chair (2)**.
2. Align the pre-installed Clip to the pre-installed Post as shown.
3. Push **EEI-4396/4397 Left Arm Chair (3)** slowly until the Clip and the Post click together tightly.

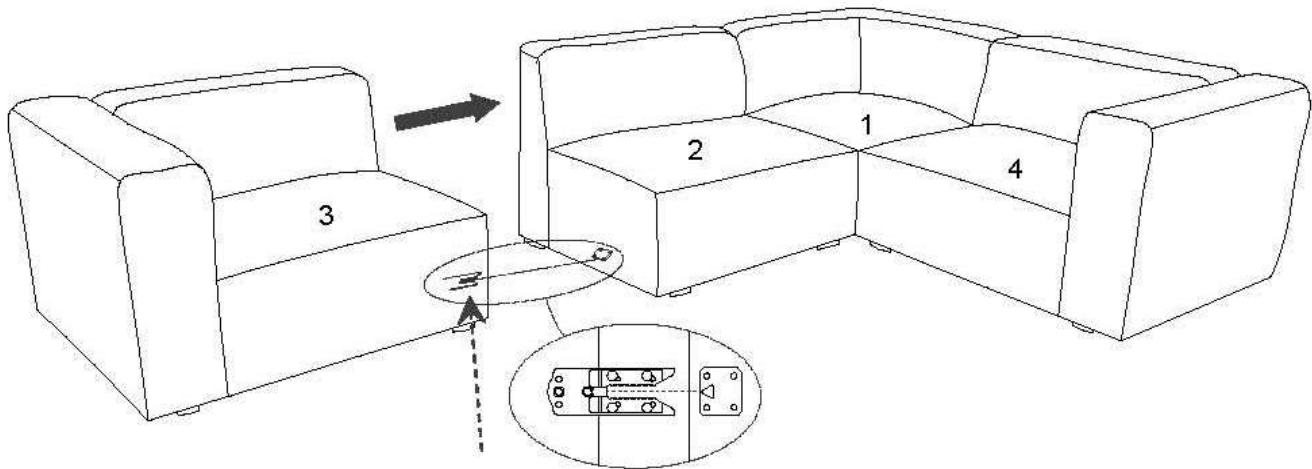

Pre-installed Clip on the
bottom of Left Arm Chair

Assembly is complete. Your sofa combination is ready to be used now!

If you want to unlock the sofa combination:

Lift up **EEI-4398/4399 Armless Chair (2)** and move **EEI-4396/4397 Left Arm Chair (3)** apart from **EEI-4398/4399 Armless Chair (2)**.

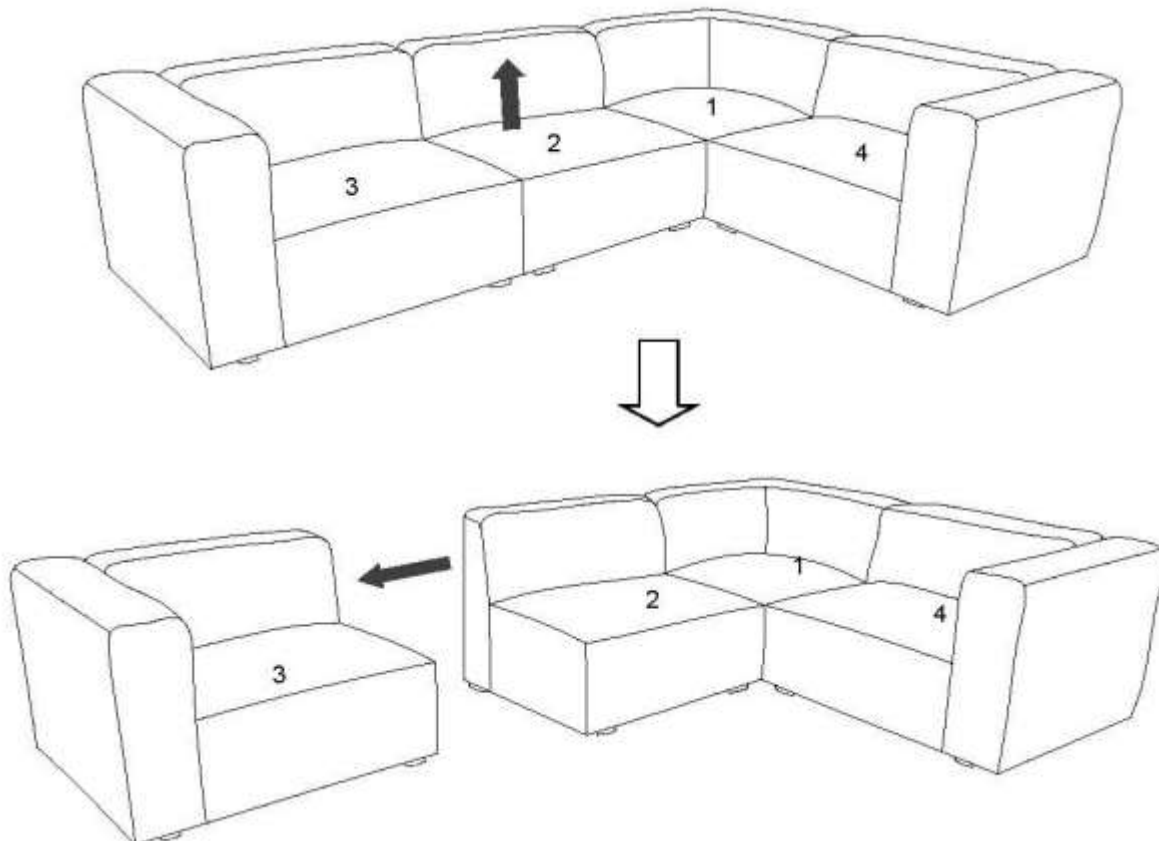

1. Lift up **EEI-4402/4403 Corner (1)** and move **EEI-4398/4399 Armless Chair (2)** apart from **EEI-4402/4403 Corner (1)** as shown.
2. Lift up **EEI-4394/4395 Right Arm Chair (4)** and move **EEI-4394/4395 Right Arm Chair (4)** apart from **EEI-4402/4403 Corner (1)** as shown.

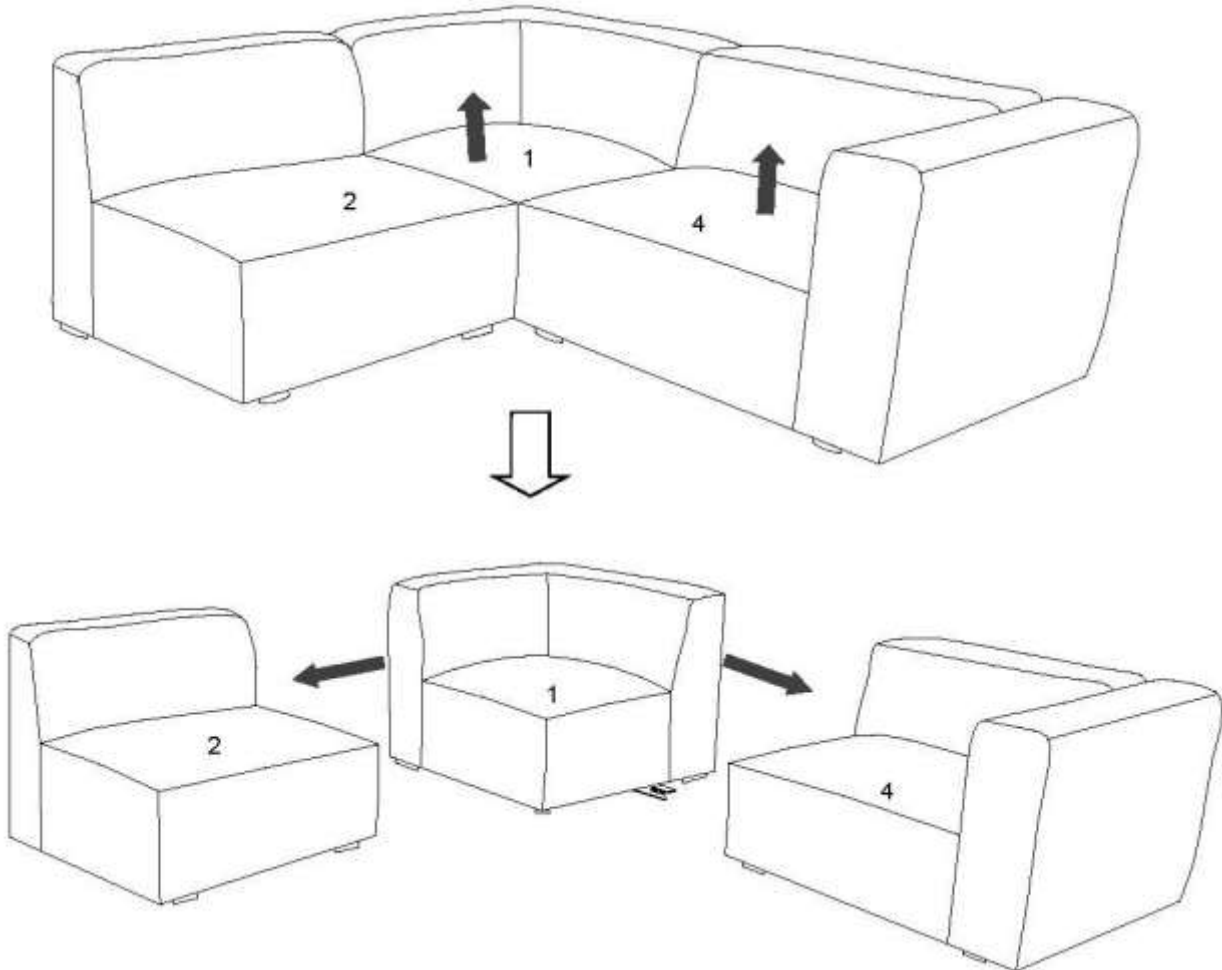

How to connect sofa sectional for

EEI-4394/4395 & EEI-4396/4397 & EEI-4398/4399 & EEI-4400/4401 & EEI-4402/4403

1. Please find the extra hardware from **EEI-4400/4401 Ottoman** carton.
2. Put **EEI-4400/4401 Ottoman** upside down on a carpeted or padded area.
3. If you want to adjust the position of the installed Post/Clip, please use Phillip Head Screwdriver (Not provided)
Tighten all Screws unscrew screw counterclockwise;
4. Take out all Screws and remove Post/Clip;
5. Place the Post/Clip to the pre-marked position on the bottom of **EEI-4400/4401 Ottoman** as shown.
6. Insert the Screws to the bottom of **EEI-4400/4401 Ottoman** through Clip/Post as shown.
7. Use Phillips Head Screwdriver (Not provided) to tighten Screws clockwise until secure.
8. Repeat the same steps to lock the Clip and Post together tightly.

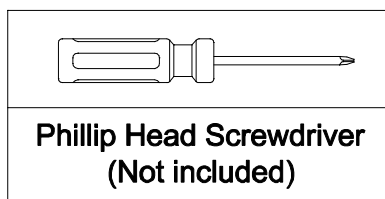
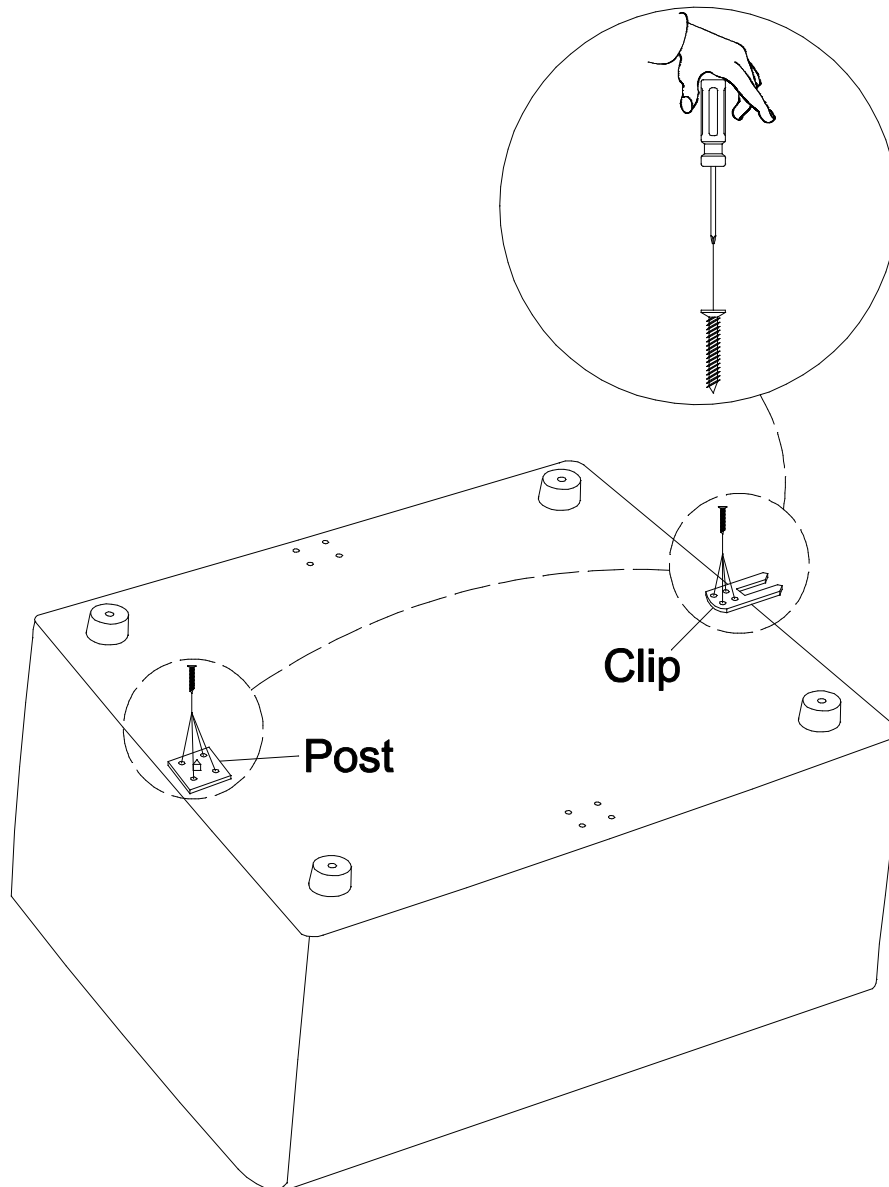

If you want to lock **EEI-4400/4401 Ottoman** to the sofa combination, the assembly instruction is as the following:

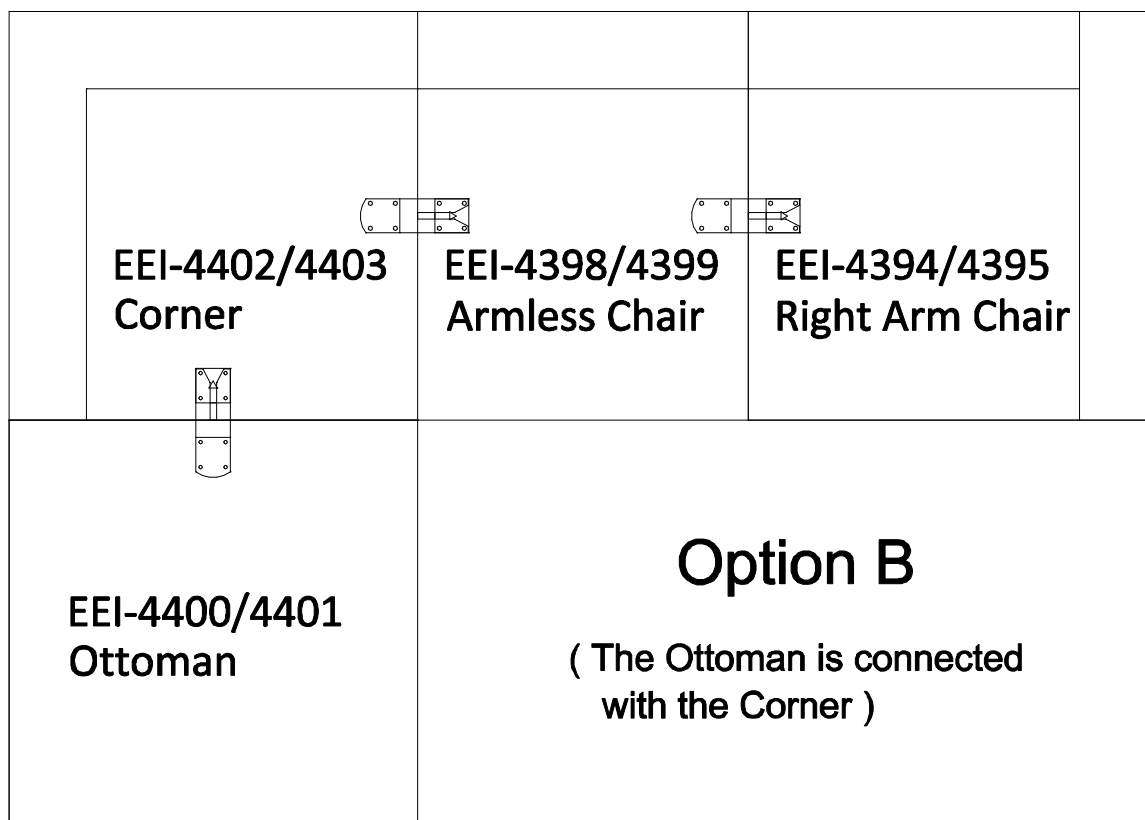
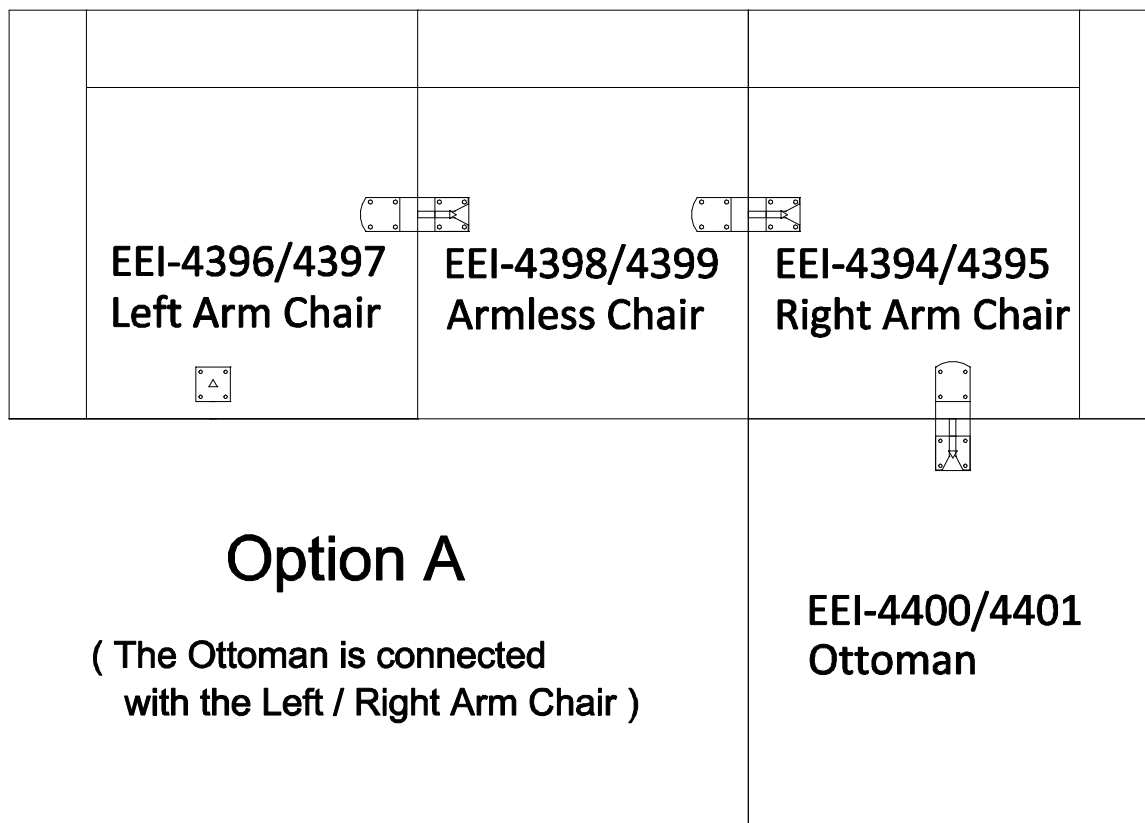

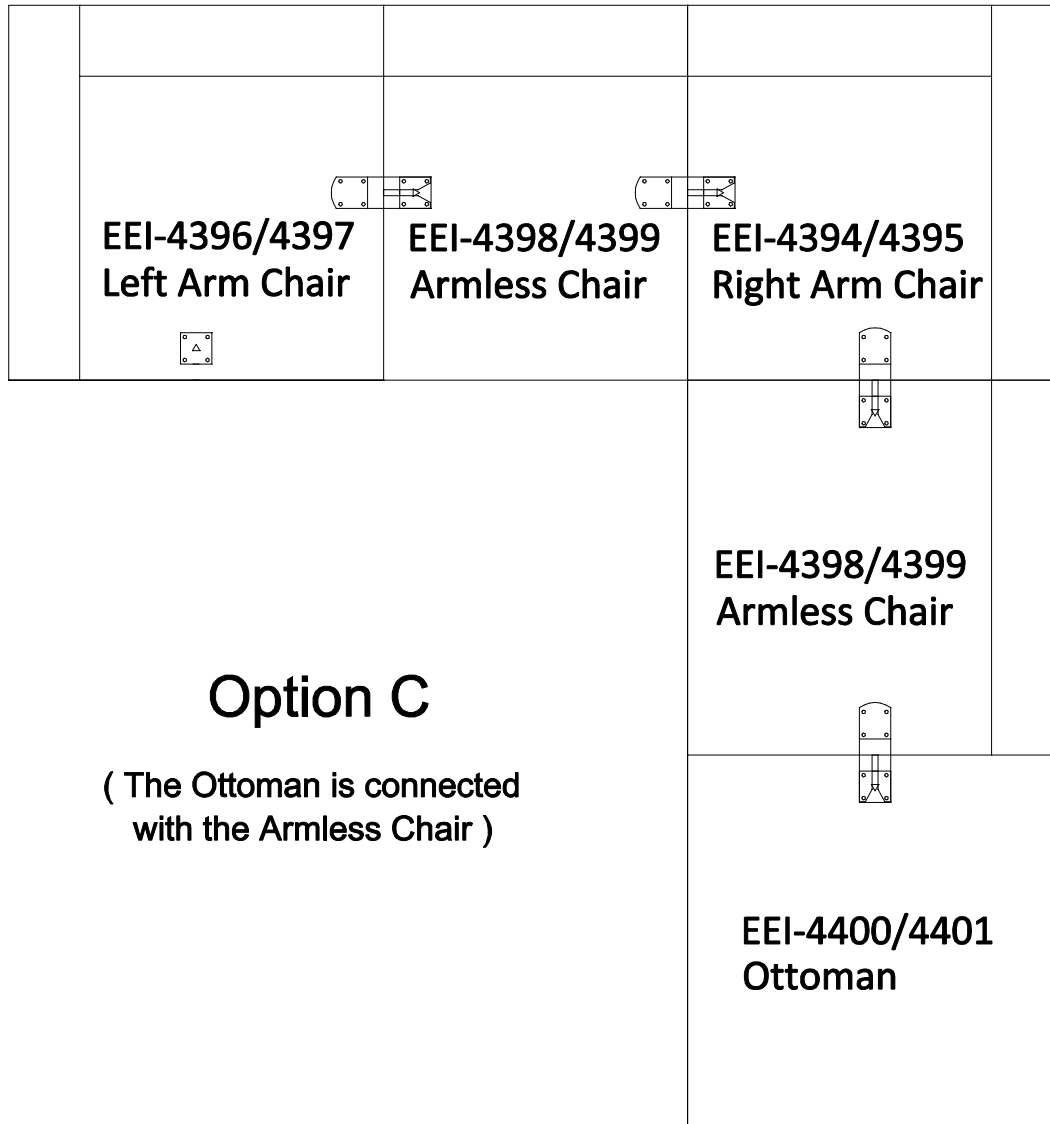

Thank you for purchasing the **MODWAY CORNER/ CHAIR/ OTTOMAN**

Before you start, here are some helpful advice:

1. We suggest you spend a short time reading through this leaflet and then follow the simple step-by-step instructions.
2. Owing to the size and weight of the sofa section, we recommend that it is assembled by two adults, on a carpeted or padded area, in the room that it is intended for. Approximate assembly time: 30 minutes.
3. Please do not use any tools other than those provided or recommended in these instructions.
4. Please do not throw away any of the packaging or the instruction until you have checked all the components and hardware and the furniture is fully assembled. Please ensure that the packaging is disposed of in a safe and environmentally friendly way.
5. Assemble all components loosely until advised to tighten. Depending on use, it may be necessary to tighten the components from time to time, so please save the tools that have been provided.
6. Please keep all pieces out of reach of children.

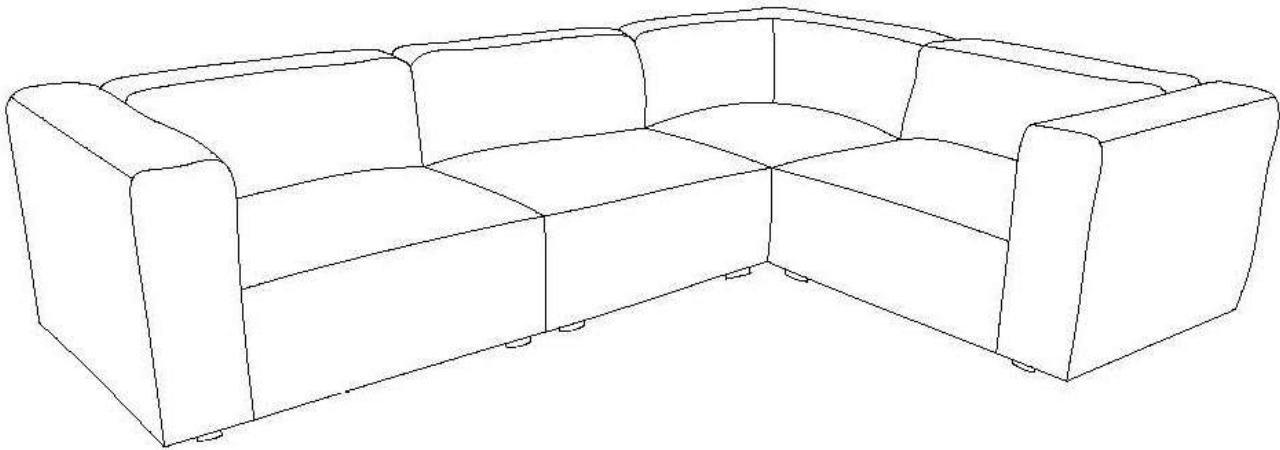

Components:

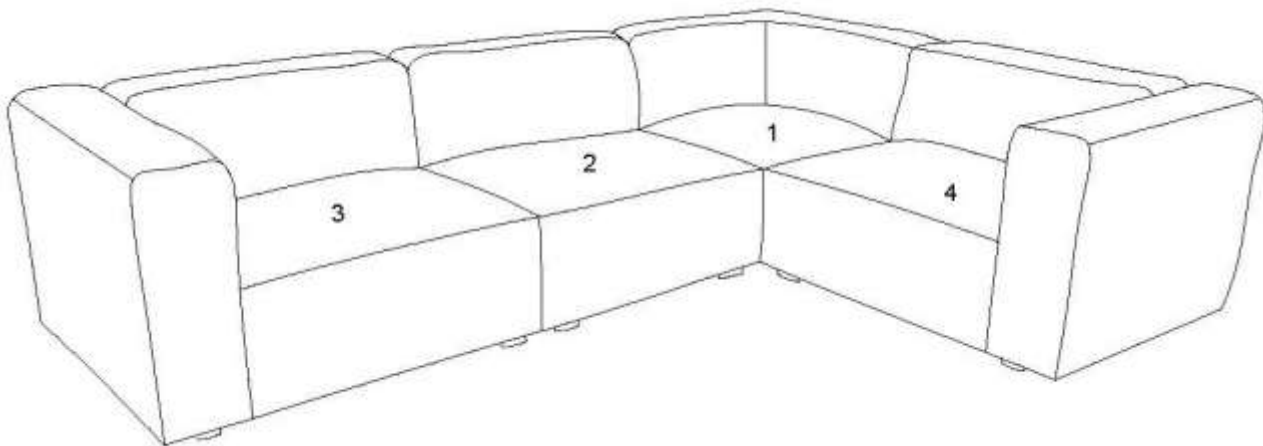

- | | | | |
|---------------------------------------|----|--|----|
| 1. E EI-4402/E EI-4403 Corner | x1 | 2. E EI-4398/E EI-4399 Armless Chair | x1 |
| 3. E EI-4396/E EI-4397 Left Arm Chair | x1 | 4. E EI-4394/E EI-4395 Right Arm Chair | x1 |

STEP 1:

Please carefully place **EEI-4402/4403 Corner (1)** at your desired location.

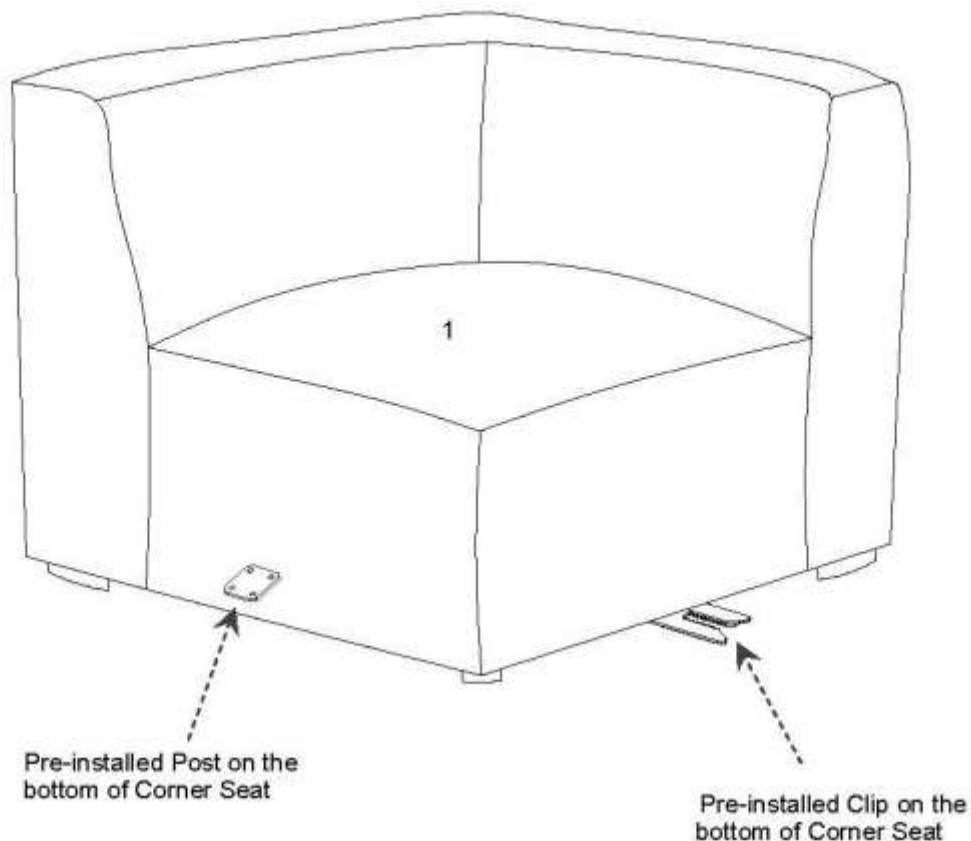

STEP 2:

1. Put **EEI-4398/4399 Armless Chair (2)** and **EEI-4394/4395 Right Arm Chair (4)** close to **EEI-4402/4403 Corner (1)**.
2. Align the pre-installed Clip to the pre-installed Post as shown.
3. Push **EEI-4398/4399 Armless Chair (2)** and **EEI-4394/4395 Right Arm Chair (4)** slowly until the Clip and the Post click together tightly.

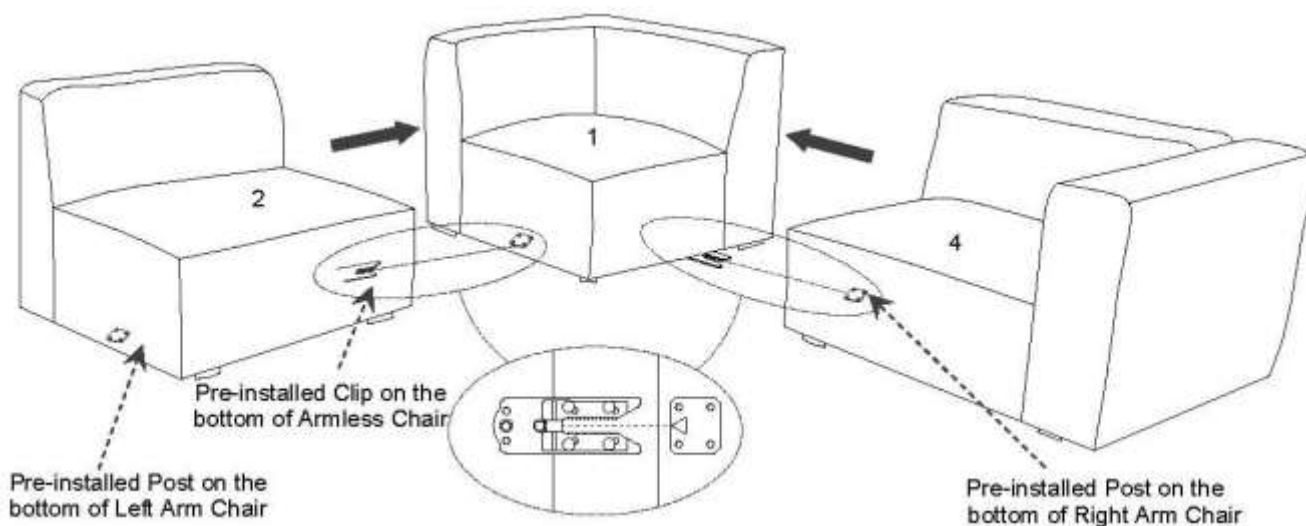

STEP 3:

1. Put **EEI-4396/4397 Left Arm Chair (3)** close to **EEI-4398/4399 Armless Chair (2)**.
2. Align the pre-installed Clip to the pre-installed Post as shown.
3. Push **EEI-4396/4397 Left Arm Chair (3)** slowly until the Clip and the Post click together tightly.

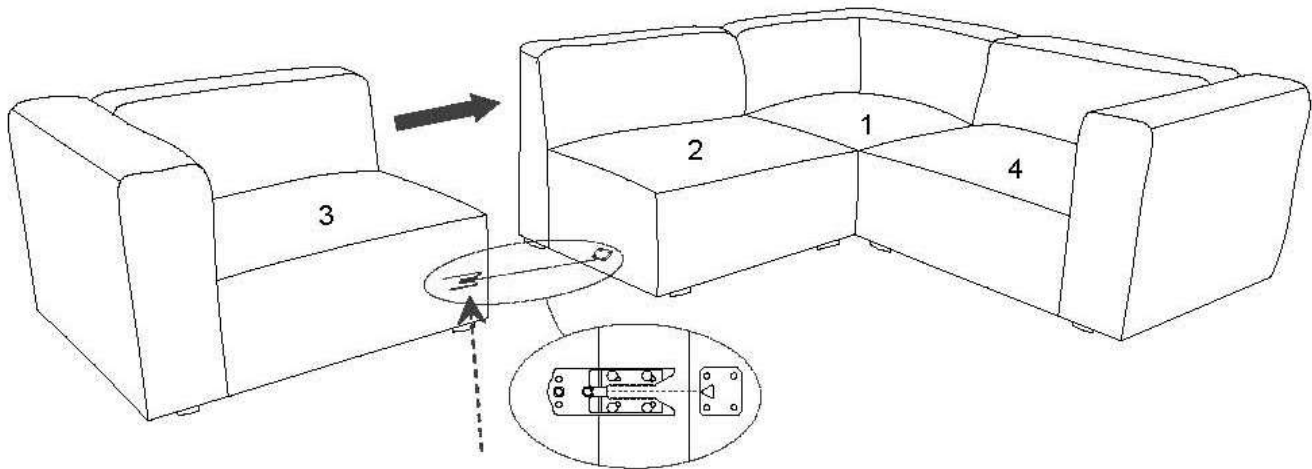

Pre-installed Clip on the
bottom of Left Arm Chair

Assembly is complete. Your sofa combination is ready to be used now!

If you want to unlock the sofa combination:

Lift up **EEI-4398/4399 Armless Chair (2)** and move **EEI-4396/4397 Left Arm Chair (3)** apart from **EEI-4398/4399 Armless Chair (2)**.

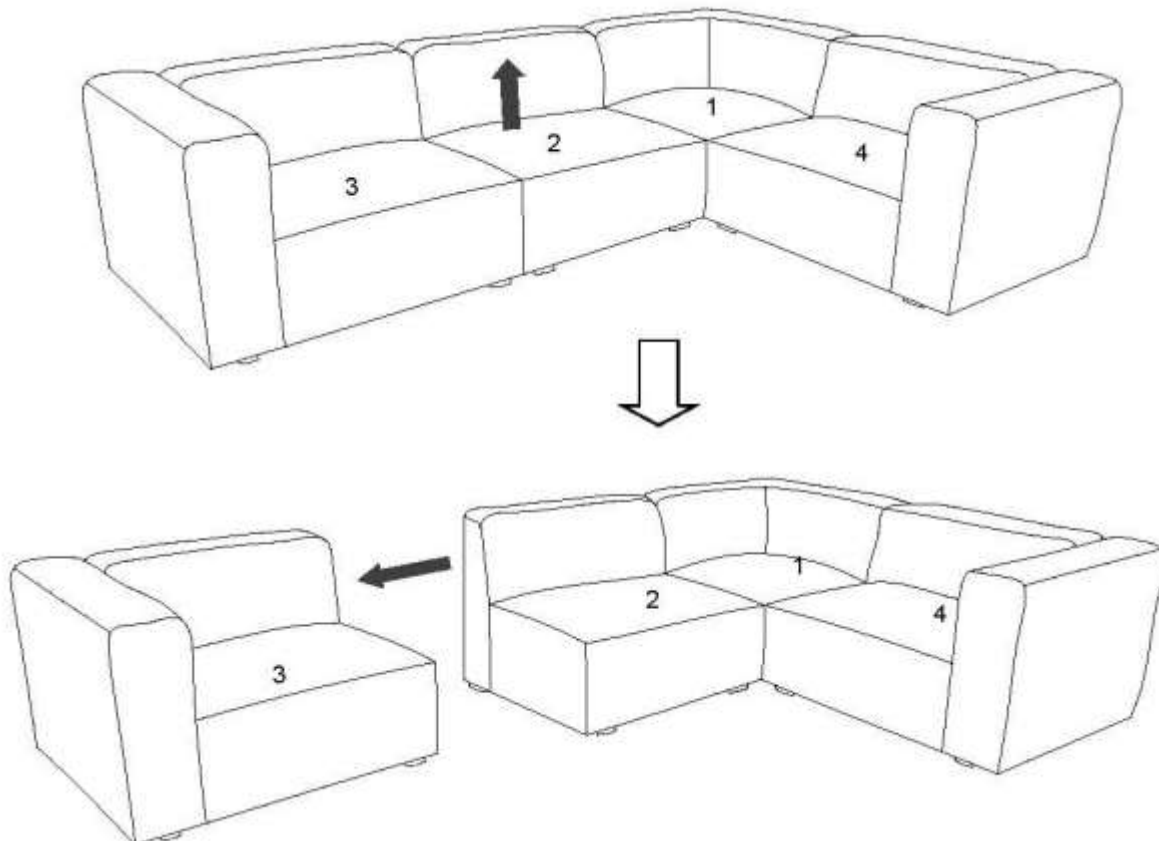

1. Lift up **EEI-4402/4403 Corner (1)** and move **EEI-4398/4399 Armless Chair (2)** apart from **EEI-4402/4403 Corner (1)** as shown.
2. Lift up **EEI-4394/4395 Right Arm Chair (4)** and move **EEI-4394/4395 Right Arm Chair (4)** apart from **EEI-4402/4403 Corner (1)** as shown.

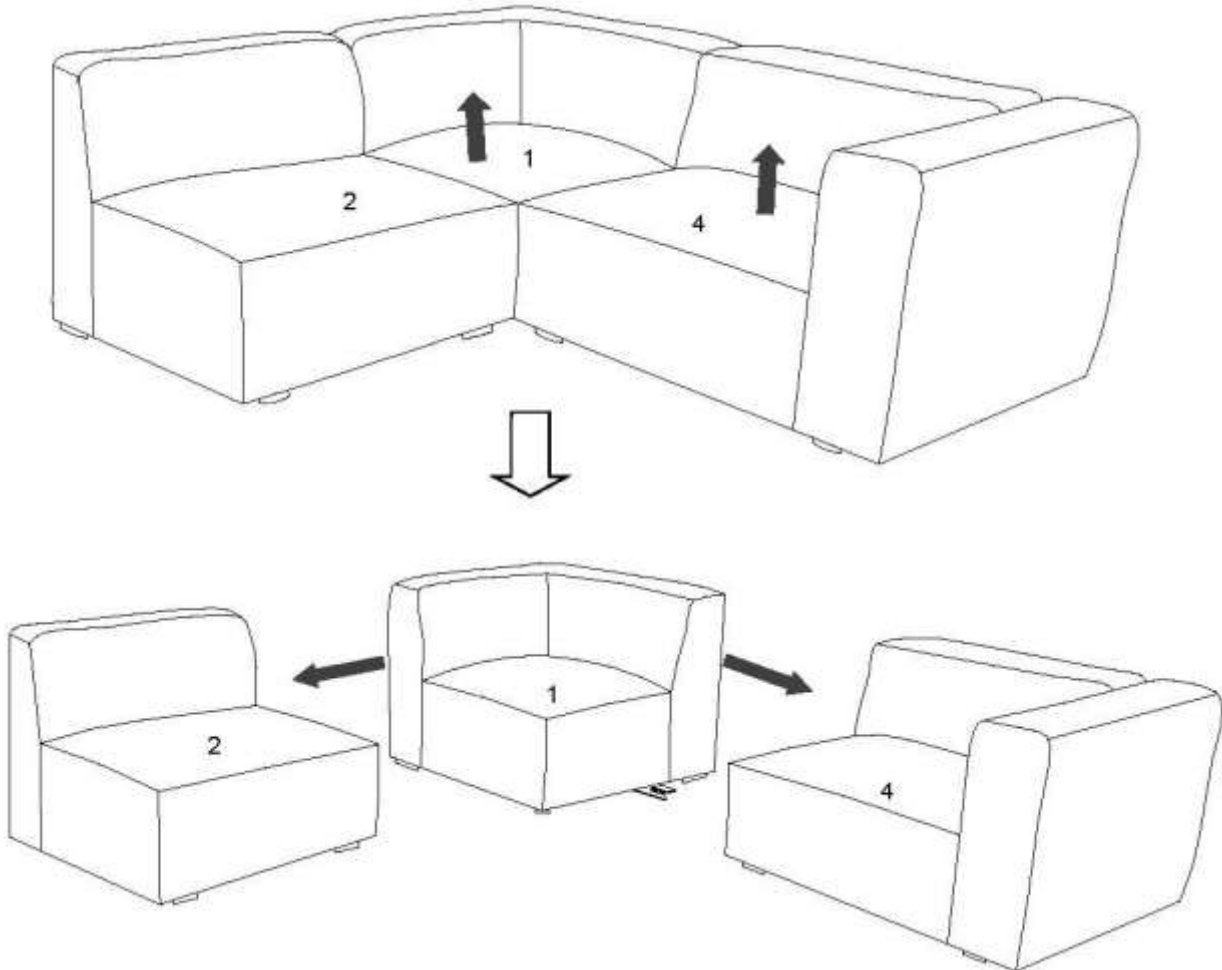

How to connect sofa sectional for

EEI-4394/4395 & EEI-4396/4397 & EEI-4398/4399 & EEI-4400/4401 & EEI-4402/4403

1. Please find the extra hardware from **EEI-4400/4401 Ottoman** carton.
2. Put **EEI-4400/4401 Ottoman** upside down on a carpeted or padded area.
3. If you want to adjust the position of the installed Post/Clip, please use Phillip Head Screwdriver (Not provided)
Tighten all Screws unscrew screw counterclockwise;
4. Take out all Screws and remove Post/Clip;
5. Place the Post/Clip to the pre-marked position on the bottom of **EEI-4400/4401 Ottoman** as shown.
6. Insert the Screws to the bottom of **EEI-4400/4401 Ottoman** through Clip/Post as shown.
7. Use Phillips Head Screwdriver (Not provided) to tighten Screws clockwise until secure.
8. Repeat the same steps to lock the Clip and Post together tightly.

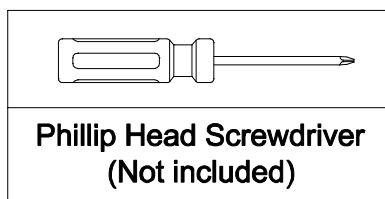
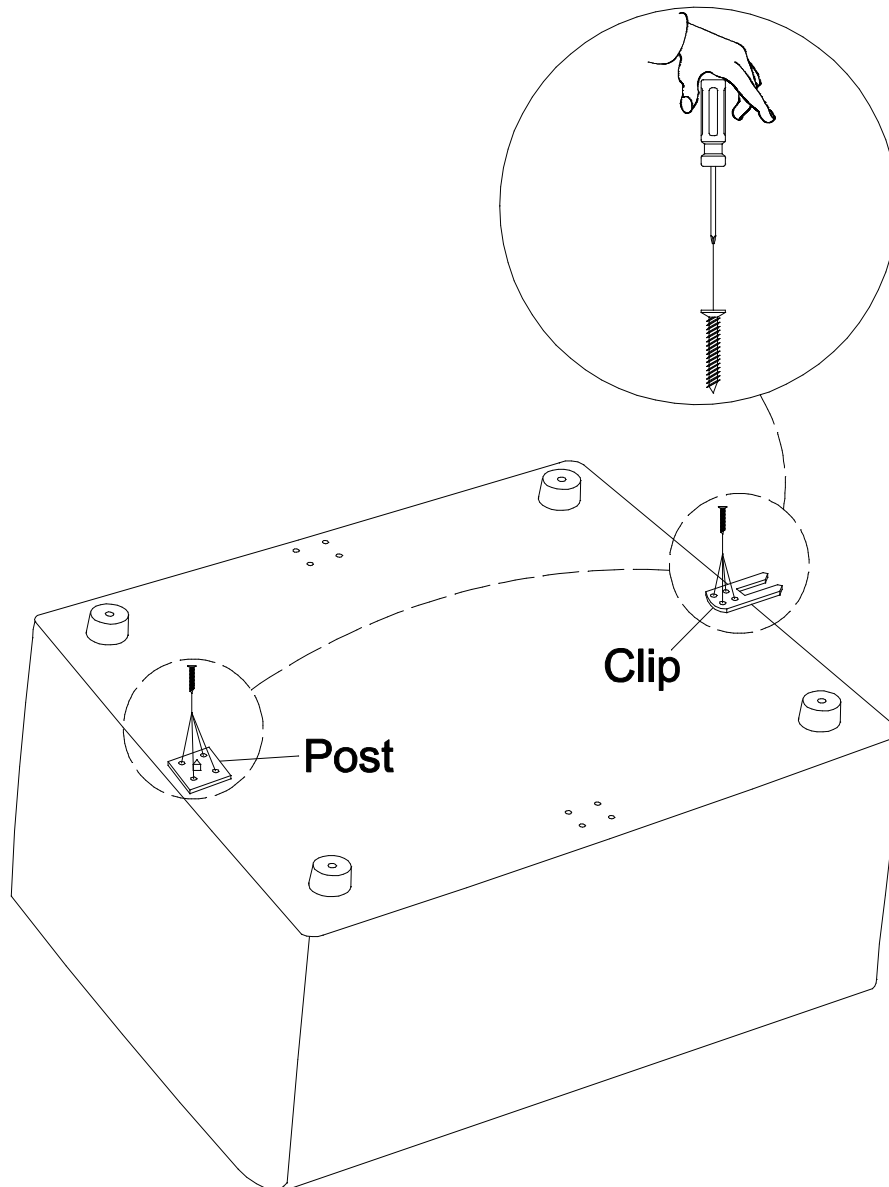

If you want to lock **EEI-4400/4401 Ottoman** to the sofa combination, the assembly instruction is as the following:

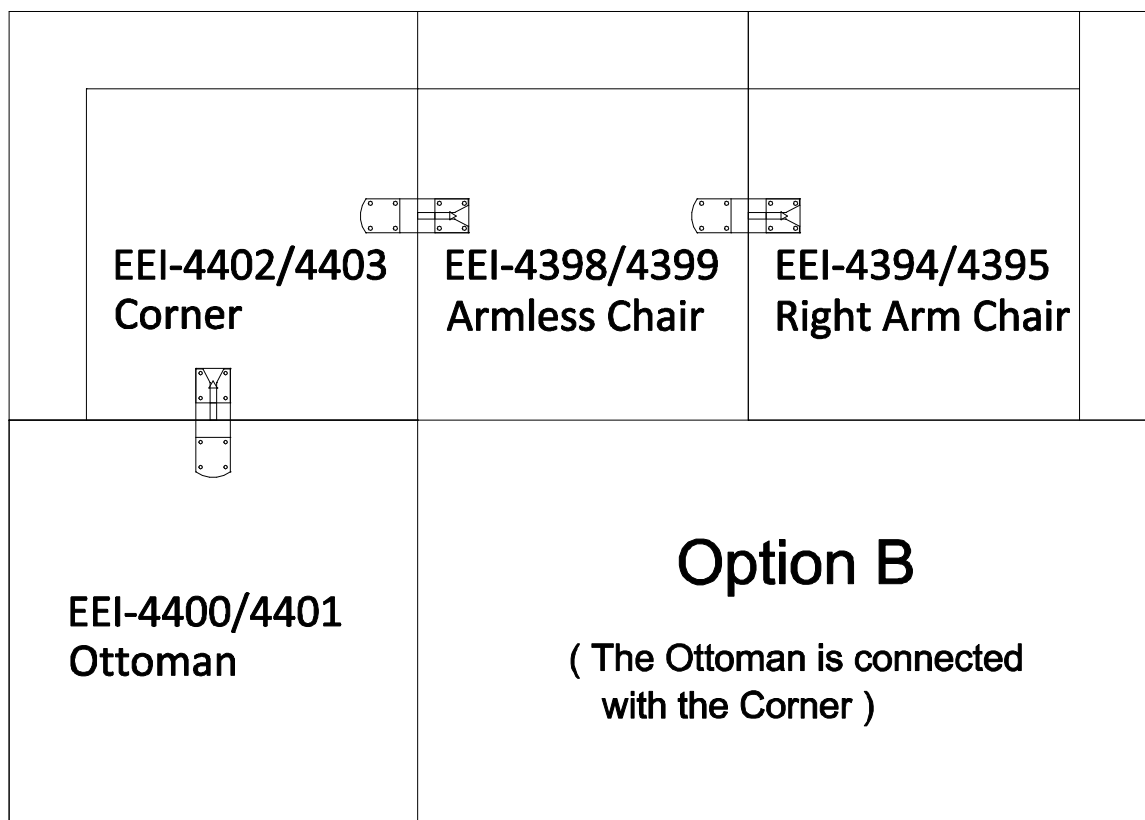
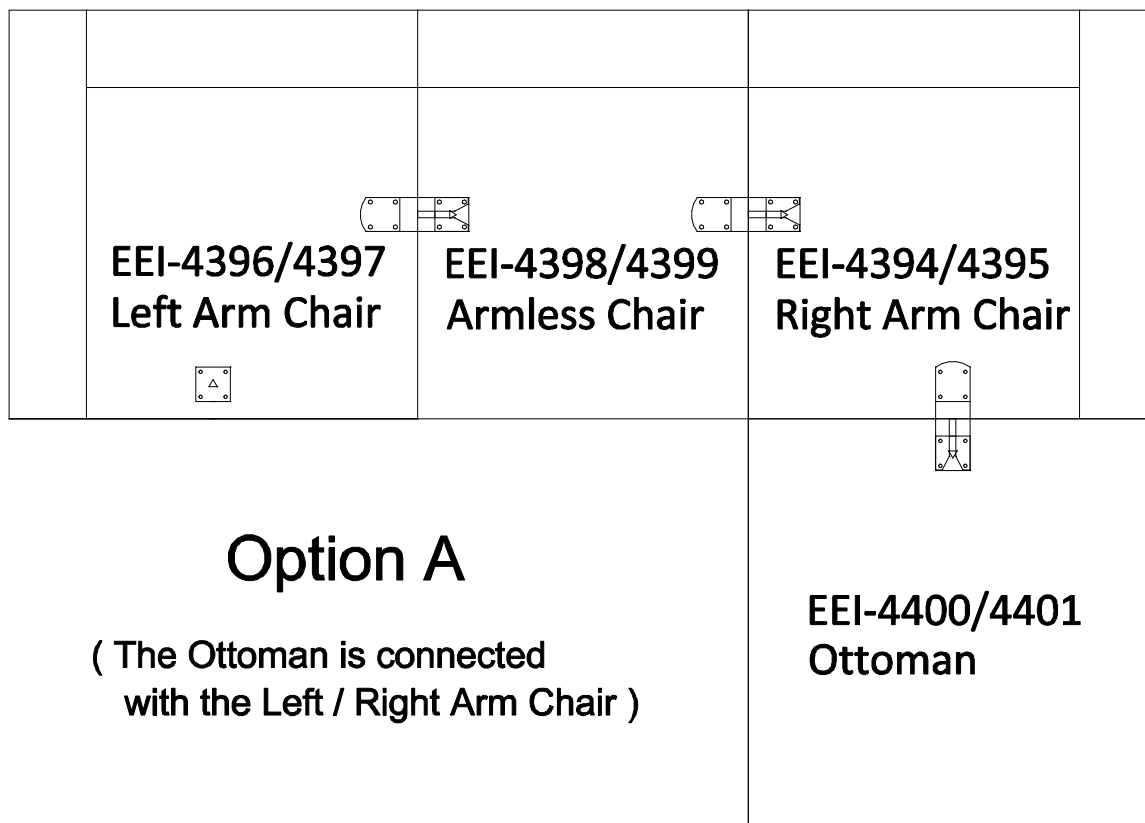

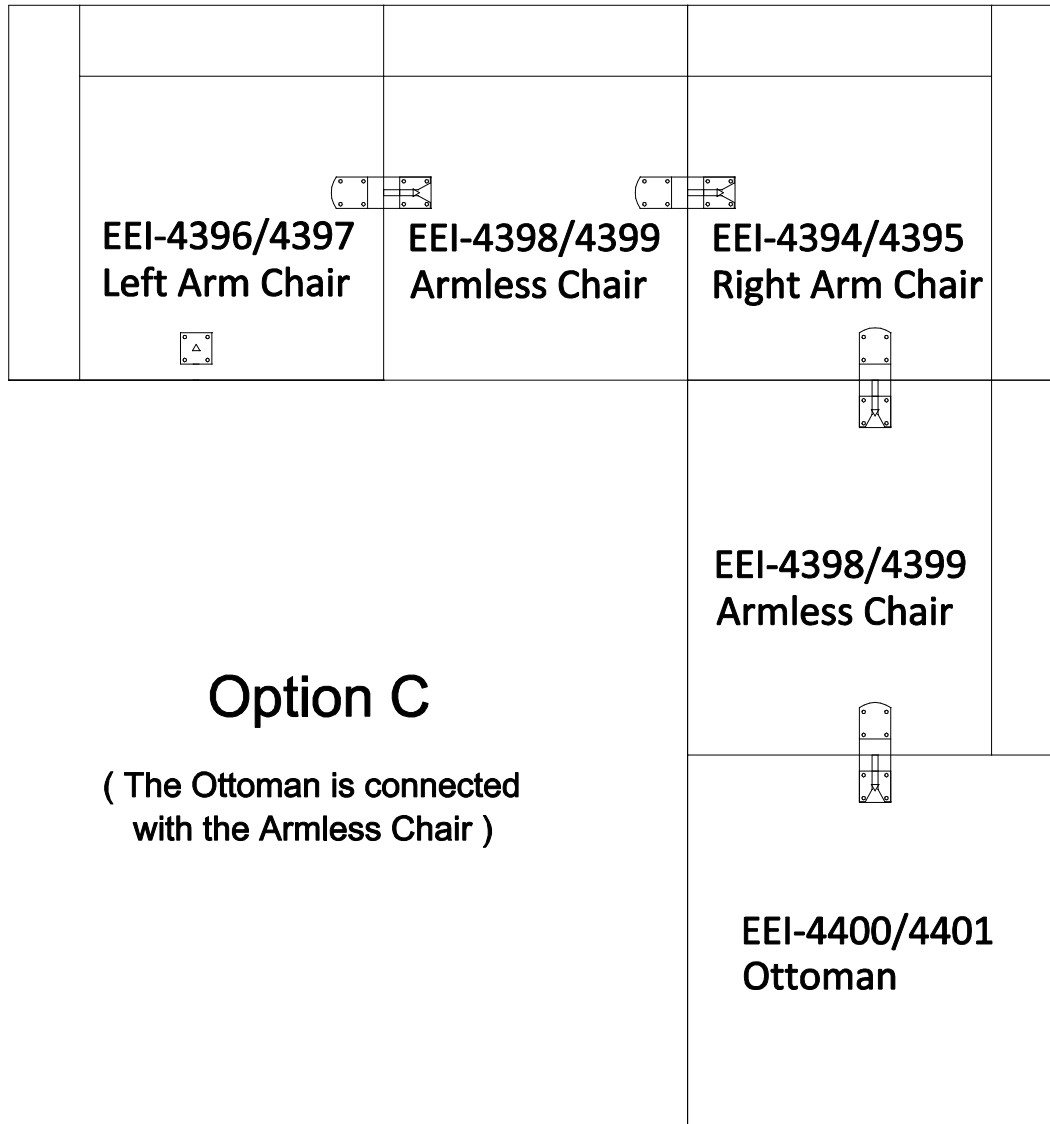

Thank you for purchasing the **MODWAY CORNER/ CHAIR/ OTTOMAN**

Before you start, here are some helpful advice:

1. We suggest you spend a short time reading through this leaflet and then follow the simple step-by-step instructions.
2. Owing to the size and weight of the sofa section, we recommend that it is assembled by two adults, on a carpeted or padded area, in the room that it is intended for. Approximate assembly time: 30 minutes.
3. Please do not use any tools other than those provided or recommended in these instructions.
4. Please do not throw away any of the packaging or the instruction until you have checked all the components and hardware and the furniture is fully assembled. Please ensure that the packaging is disposed of in a safe and environmentally friendly way.
5. Assemble all components loosely until advised to tighten. Depending on use, it may be necessary to tighten the components from time to time, so please save the tools that have been provided.
6. Please keep all pieces out of reach of children.

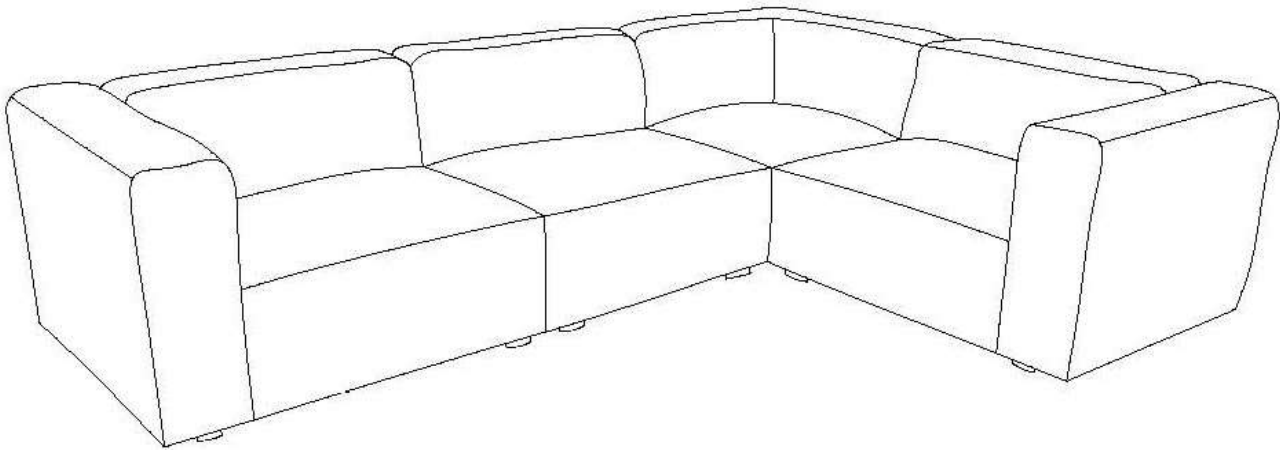

Components:

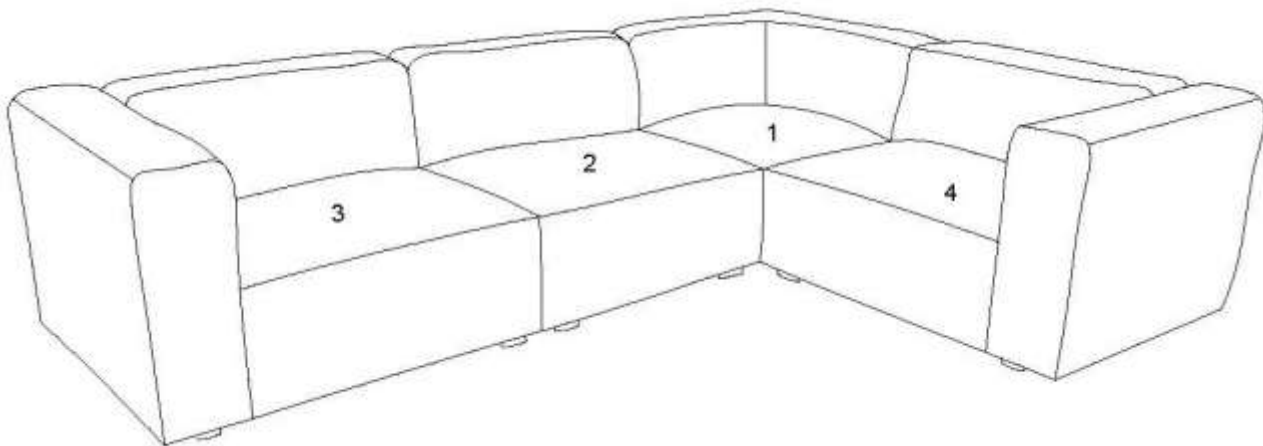

- | | | | |
|---------------------------------------|----|--|----|
| 1. E EI-4402/E EI-4403 Corner | x1 | 2. E EI-4398/E EI-4399 Armless Chair | x1 |
| 3. E EI-4396/E EI-4397 Left Arm Chair | x1 | 4. E EI-4394/E EI-4395 Right Arm Chair | x1 |

STEP 1:

Please carefully place **EEI-4402/4403 Corner (1)** at your desired location.

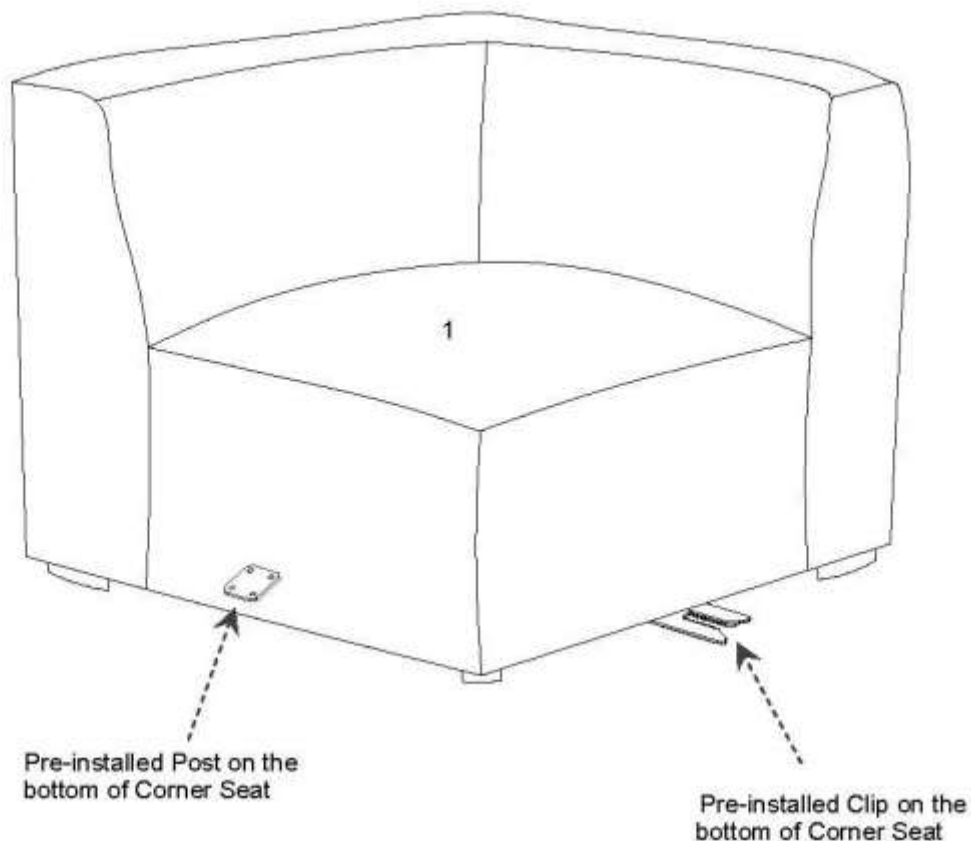

STEP 2:

1. Put **EEI-4398/4399 Armless Chair (2)** and **EEI-4394/4395 Right Arm Chair (4)** close to **EEI-4402/4403 Corner (1)**.
2. Align the pre-installed Clip to the pre-installed Post as shown.
3. Push **EEI-4398/4399 Armless Chair (2)** and **EEI-4394/4395 Right Arm Chair (4)** slowly until the Clip and the Post click together tightly.

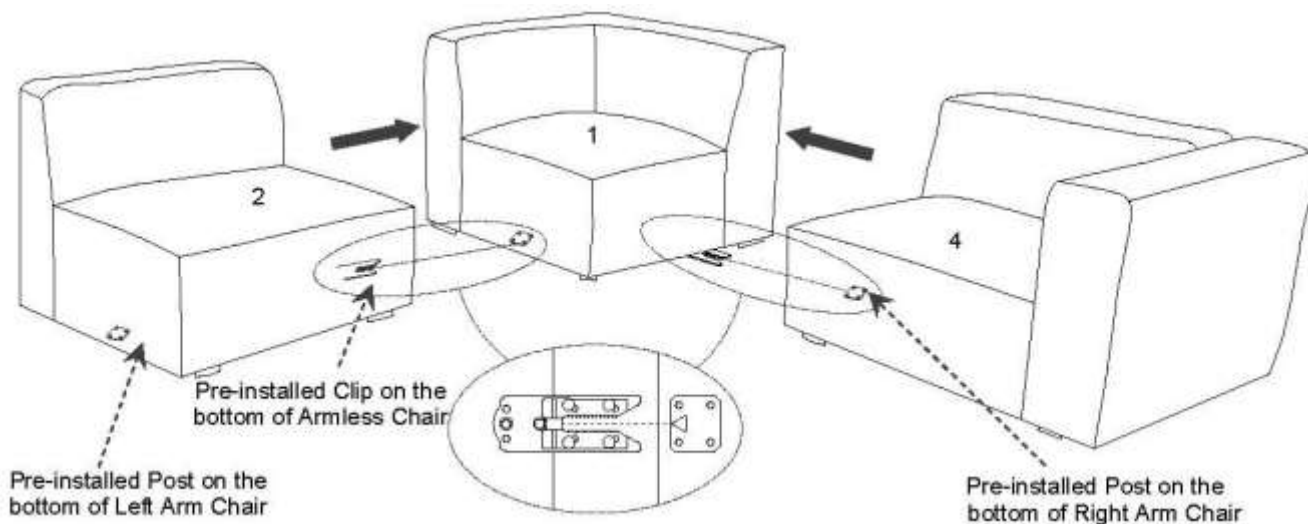

STEP 3:

1. Put **EEI-4396/4397 Left Arm Chair (3)** close to **EEI-4398/4399 Armless Chair (2)**.
2. Align the pre-installed Clip to the pre-installed Post as shown.
3. Push **EEI-4396/4397 Left Arm Chair (3)** slowly until the Clip and the Post click together tightly.

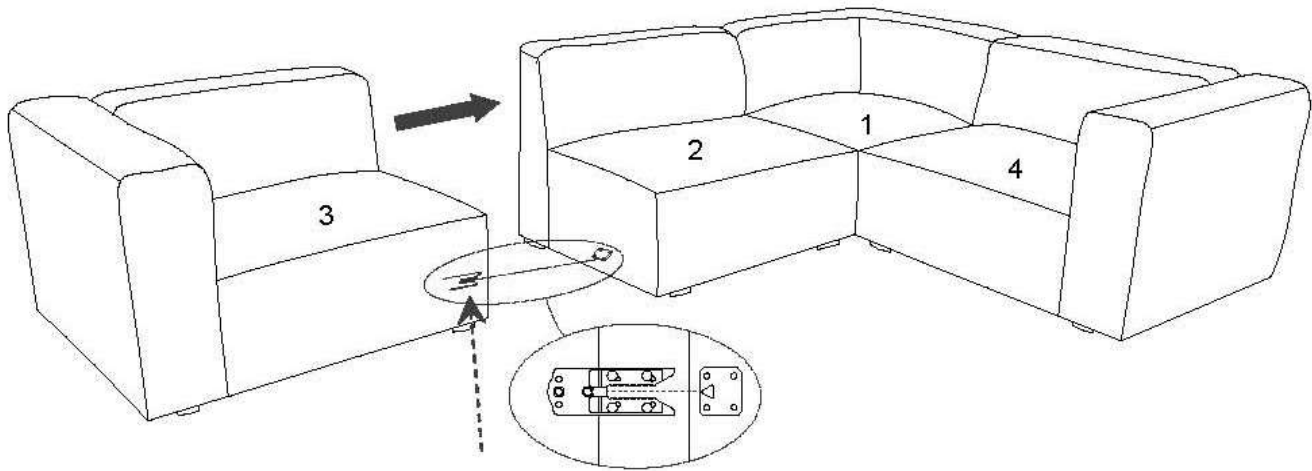

Pre-installed Clip on the
bottom of Left Arm Chair

Assembly is complete. Your sofa combination is ready to be used now!

If you want to unlock the sofa combination:

Lift up **EEI-4398/4399 Armless Chair (2)** and move **EEI-4396/4397 Left Arm Chair (3)** apart from **EEI-4398/4399 Armless Chair (2)**.

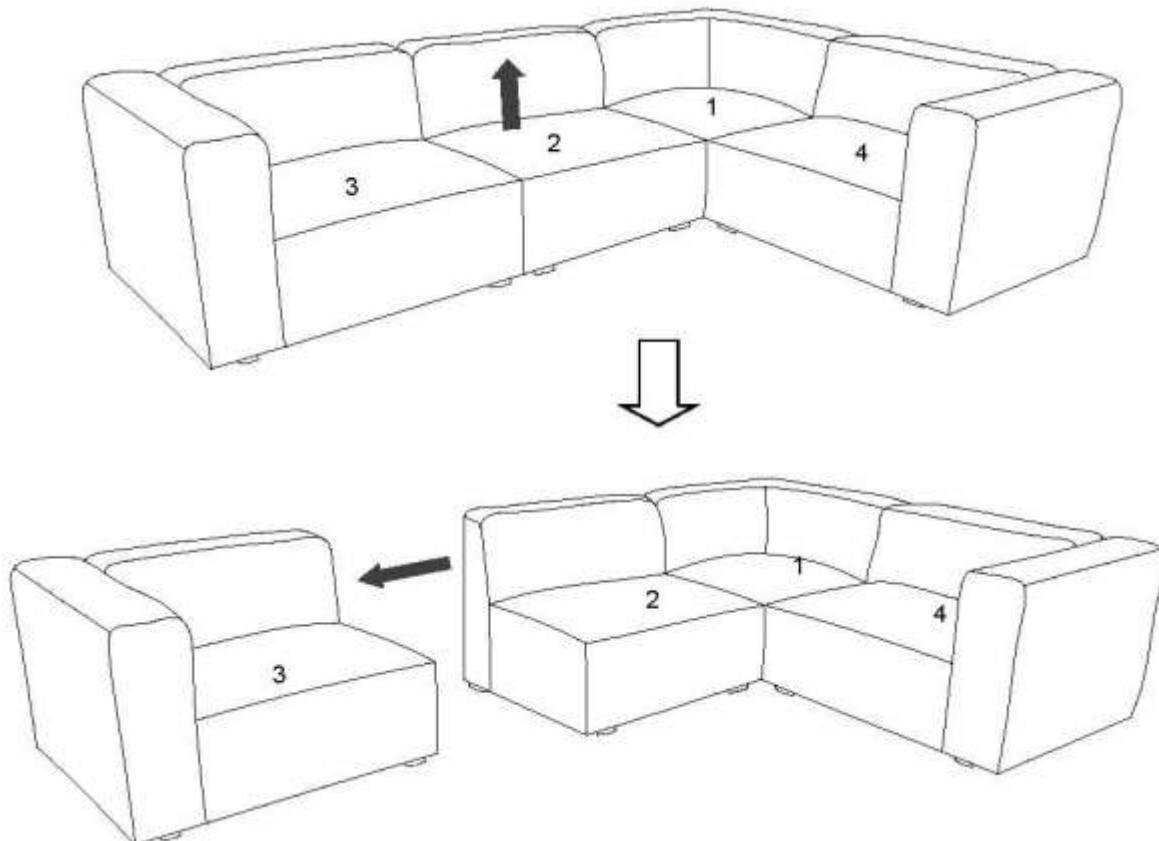

1. Lift up **EEI-4402/4403 Corner (1)** and move **EEI-4398/4399 Armless Chair (2)** apart from **EEI-4402/4403 Corner (1)** as shown.
2. Lift up **EEI-4394/4395 Right Arm Chair (4)** and move **EEI-4394/4395 Right Arm Chair (4)** apart from **EEI-4402/4403 Corner (1)** as shown.

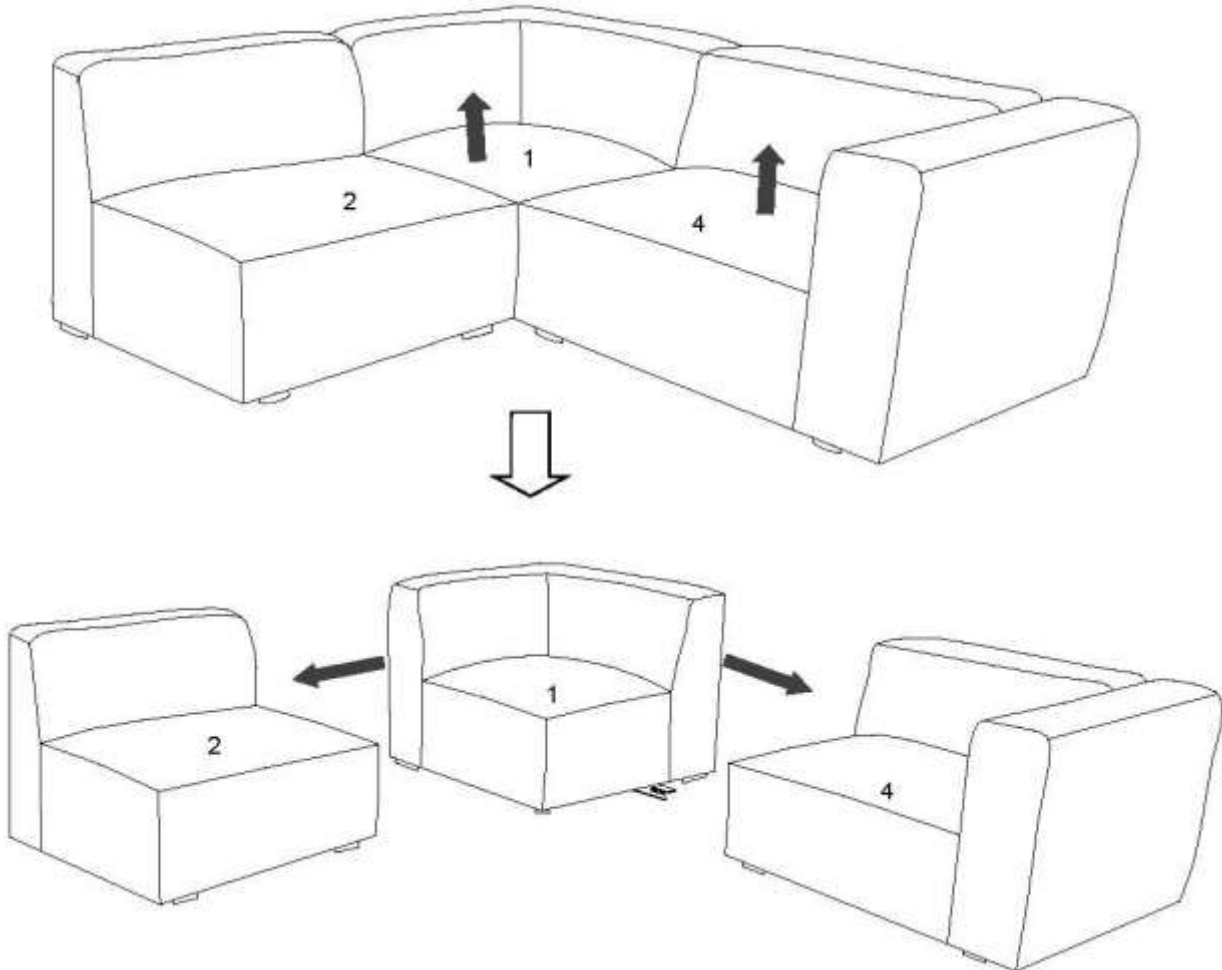

How to connect sofa sectional for

EEI-4394/4395 & EEI-4396/4397 & EEI-4398/4399 & EEI-4400/4401 & EEI-4402/4403

1. Please find the extra hardware from **EEI-4400/4401 Ottoman** carton.
2. Put **EEI-4400/4401 Ottoman** upside down on a carpeted or padded area.
3. If you want to adjust the position of the installed Post/Clip, please use Phillip Head Screwdriver (Not provided)
Tighten all Screws unscrew screw counterclockwise;
4. Take out all Screws and remove Post/Clip;
5. Place the Post/Clip to the pre-marked position on the bottom of **EEI-4400/4401 Ottoman** as shown.
6. Insert the Screws to the bottom of **EEI-4400/4401 Ottoman** through Clip/Post as shown.
7. Use Phillips Head Screwdriver (Not provided) to tighten Screws clockwise until secure.
8. Repeat the same steps to lock the Clip and Post together tightly.

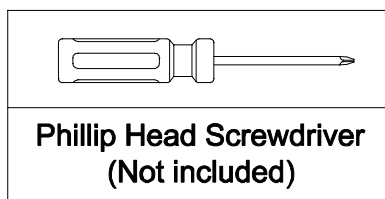
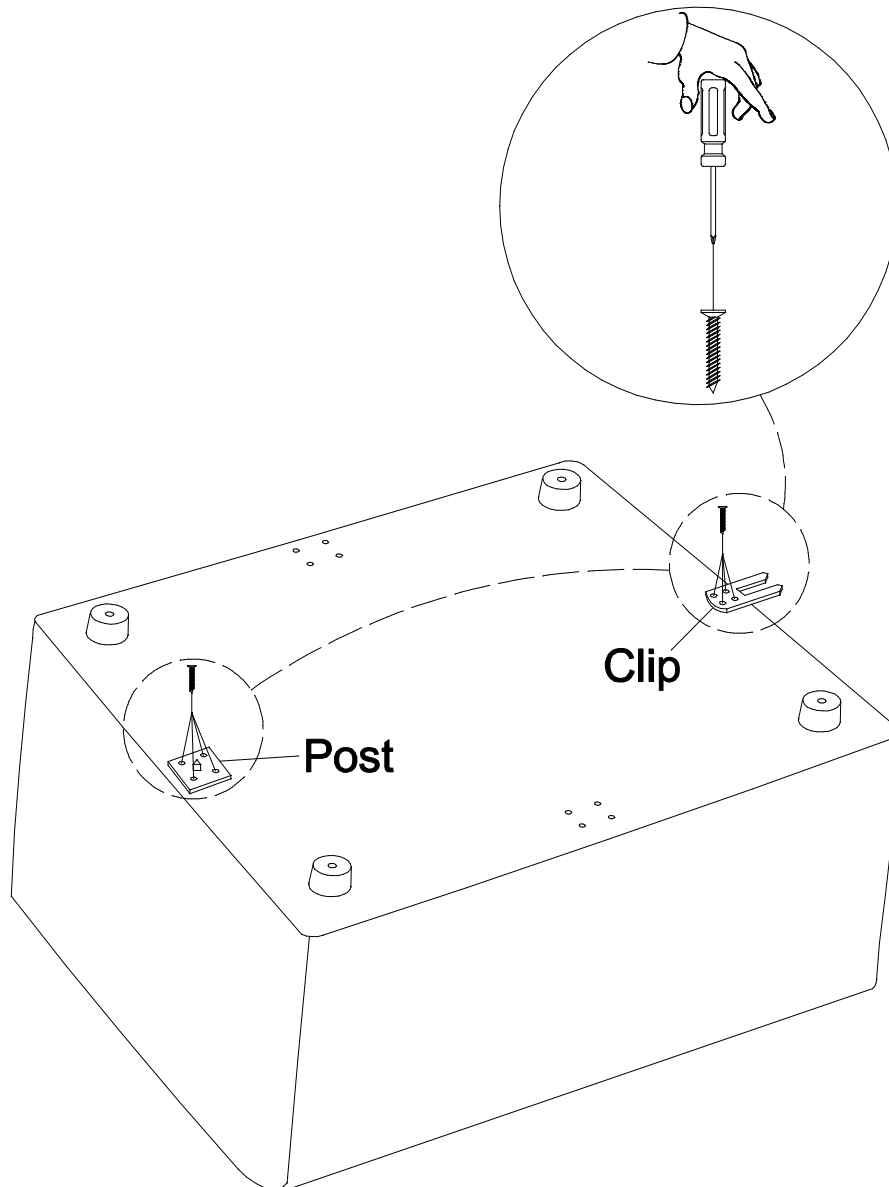

If you want to lock **EEI-4400/4401 Ottoman** to the sofa combination, the assembly instruction is as the following:

