

Thank you for purchasing the **MODWAY Chair/ Loveseat/ Sofa**.

Before you start, here are some helpful advice:

1. We suggest you spend a short time reading through this leaflet and then follow the simple step-by-step instructions.
2. Owing to the size and weight of the table/loveseat, we recommend that it is assembled by two adults, on a carpeted or padded area, in the room that it is intended for. Approximate assembly time: 30 minutes.
3. Please do not use any tools other than those provided or recommended in these instructions.
4. Please do not throw away any of the packaging or the instruction until you have checked all the components and hardware and the furniture is fully assembled. Please ensure that the packaging is disposed of in a safe and environmentally friendly way.
5. Assemble all components loosely until advised to tighten. Depending on use, it may be necessary to tighten the components from time to time, so please save the tools that have been provided.
6. Please keep all pieces out of reach of children.



EEI-3446 Chair

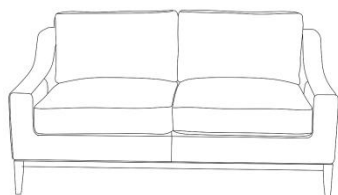

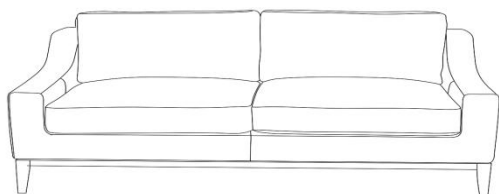

EEI-3445 Loveseat



EEI-3444 Sofa

A.  Bolt M8*60mm x 4

B.  Flat Washer $\phi 8.59-22*1.18\text{mm}$ x 4

C.  Allen Wrench M5 x 1

Components:

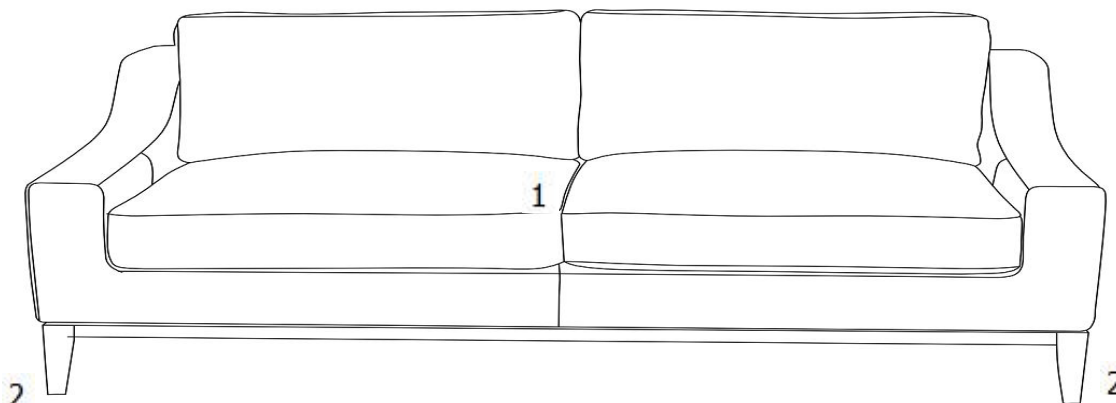

1. Sofa body x1

2. Leg x 4

STEP 1:

Please put the **Sofa Body (1)** upside down on a carpeted or padded area by two adults.
 Open the Zipper on the bottom of **Sofa Body (1)** as shown.
 Take out the 4 pieces of **Legs (2)** and hardware package on the bottom of the **Sofa Body (1)**.
 Attach 1 piece of **Leg (2)** to the bottom of **Sofa Body (1)** by using 1 piece of **Bolt (A)** with 1 piece of **Flat Washer (B)** as shown.
 Repeat the same steps for other 3 pieces of **Legs (2)**.
 Tighten **Bolts (A)** by using **Allen Wrench (C)** as shown.

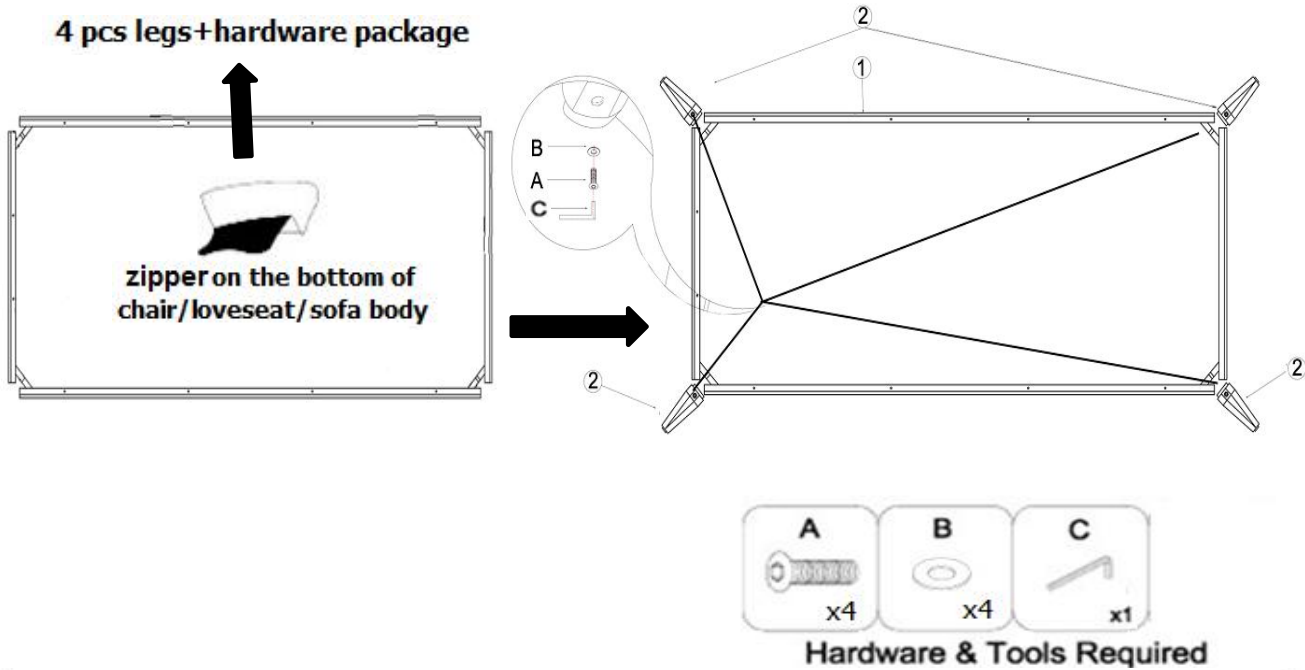

STEP 2:

Close the zipper on the bottom of the **Sofa Body (1)**.
 Carefully turn over the assembled **Sofa Body (1)** and **Legs (2)** from step 1 as shown.

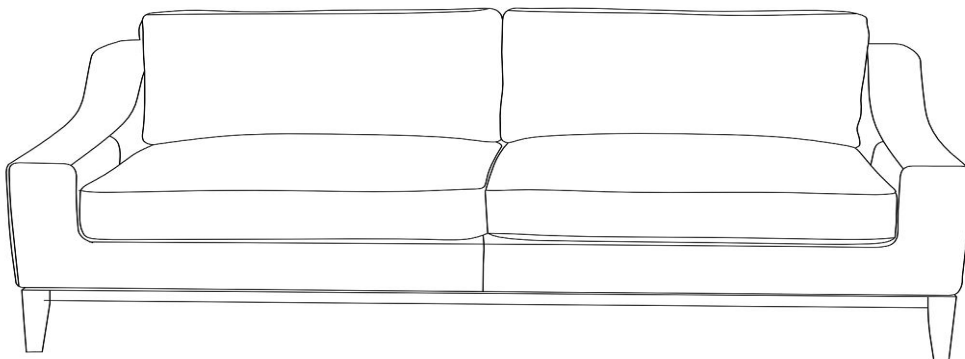

Assembly is complete. Your Sofa is ready to enjoy now!

Thank you for purchasing the **MODWAY Chair/ Loveseat/ Sofa**.

Before you start, here are some helpful advice:

1. We suggest you spend a short time reading through this leaflet and then follow the simple step-by-step instructions.
2. Owing to the size and weight of the table/loveseat, we recommend that it is assembled by two adults, on a carpeted or padded area, in the room that it is intended for. Approximate assembly time: 30 minutes.
3. Please do not use any tools other than those provided or recommended in these instructions.
4. Please do not throw away any of the packaging or the instruction until you have checked all the components and hardware and the furniture is fully assembled. Please ensure that the packaging is disposed of in a safe and environmentally friendly way.
5. Assemble all components loosely until advised to tighten. Depending on use, it may be necessary to tighten the components from time to time, so please save the tools that have been provided.
6. Please keep all pieces out of reach of children.



EEI-3446 Chair

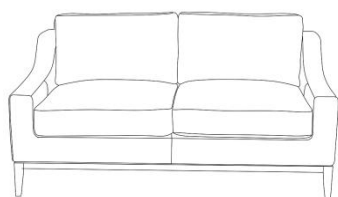

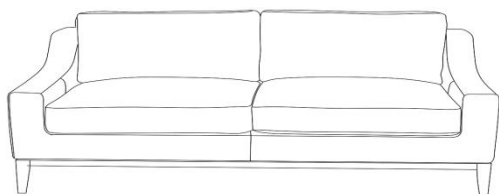

EEI-3445 Loveseat



EEI-3444 Sofa

A.  Bolt M8*60mm x 4

B.  Flat Washer $\phi 8.59-22*1.18\text{mm}$ x 4

C.  Allen Wrench M5 x 1

Components:

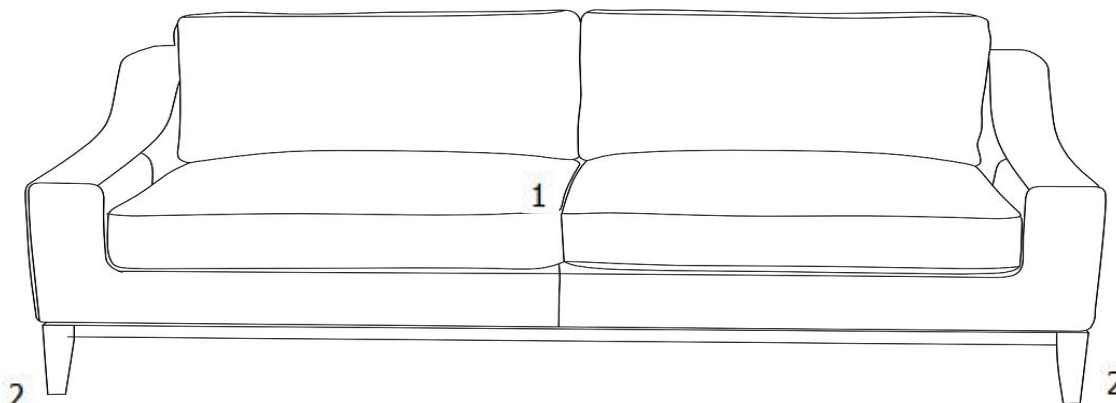

1. Sofa body x1

2. Leg x 4

STEP 1:

Please put the **Sofa Body (1)** upside down on a carpeted or padded area by two adults.
 Open the Zipper on the bottom of **Sofa Body (1)** as shown.
 Take out the 4 pieces of **Legs (2)** and hardware package on the bottom of the **Sofa Body (1)**.
 Attach 1 piece of **Leg (2)** to the bottom of **Sofa Body (1)** by using 1 piece of **Bolt (A)** with 1 piece of **Flat Washer (B)** as shown.
 Repeat the same steps for other 3 pieces of **Legs (2)**.
 Tighten **Bolts (A)** by using **Allen Wrench (C)** as shown.

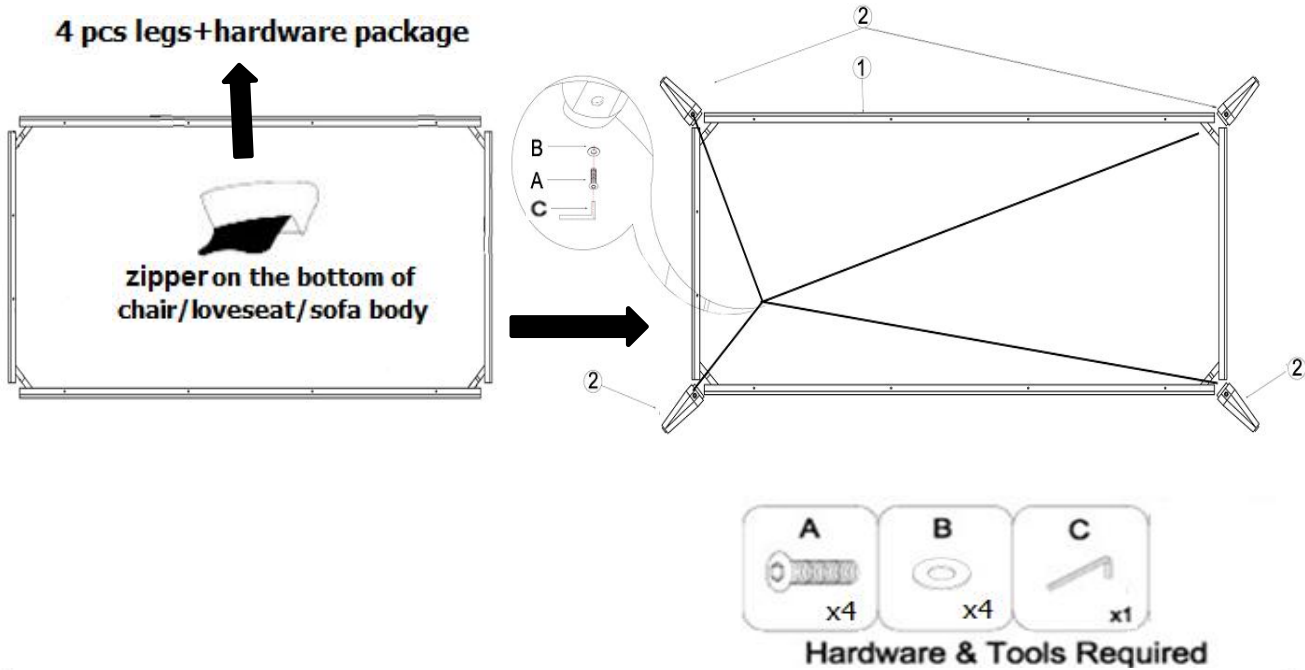

STEP 2:

Close the zipper on the bottom of the **Sofa Body (1)**.
 Carefully turn over the assembled **Sofa Body (1)** and **Legs (2)** from step 1 as shown.

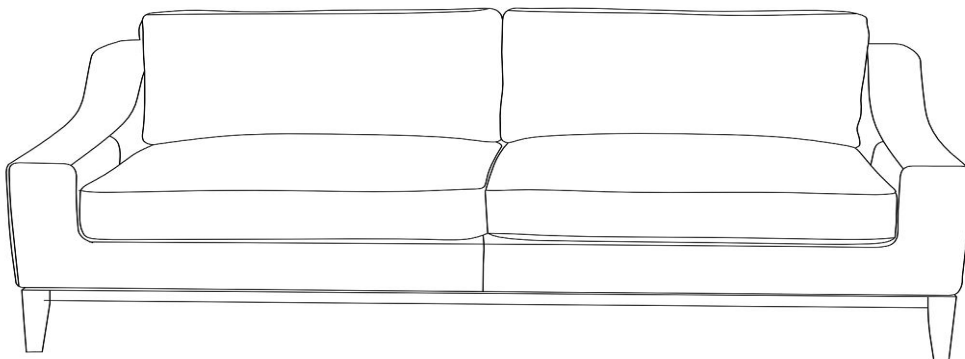

Assembly is complete. Your Sofa is ready to enjoy now!