

# ASSEMBLY INSTRUCTIONS

# EEI-3385

V1.09.01.23

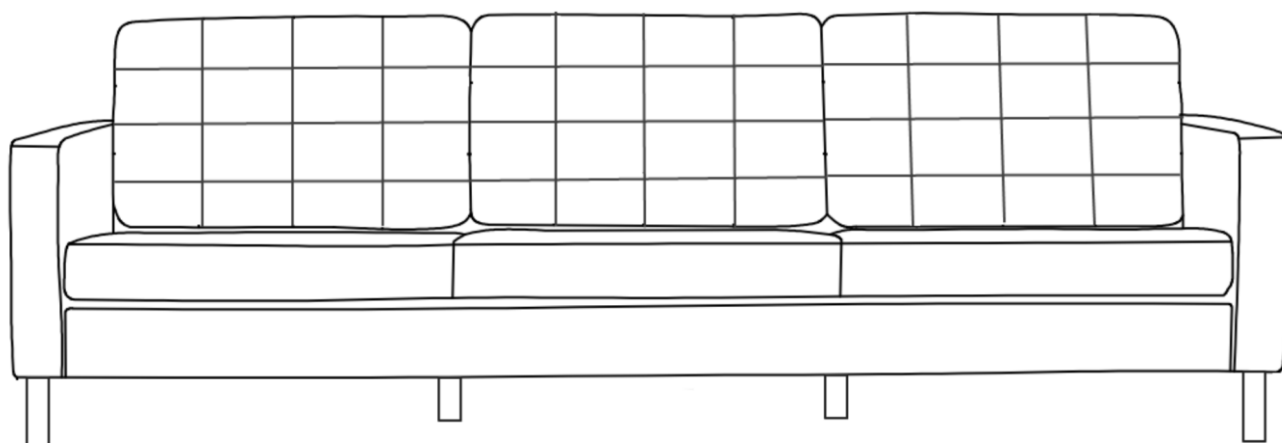

**Questions? Contact us!**

609.256.9000 • [cs@modway.com](mailto:cs@modway.com)  
[www.modway.com](http://www.modway.com)

\*modway

# Let's get started!

\*modway



Read through all of the instructions before starting



Care instructions are listed in the last step of this manual



Approx. 30 minutes assembly time



Make sure you have all parts and components before discarding any packing materials



2 people recommended for assembly

**Only use hand tools to assemble this item.** Do not use power tools. Do not tighten bolts or screws completely until all hardware is lined up and inserted into the holes.

Do not over-tighten screws and bolts to avoid stripping the hardware or cracking the item.

Assemble your item on a flat, carpeted area, with plenty of space to work. This will prevent damage and scratches to your floors or the item while you're assembling the product.

Keep all components and packaging out of reach of children or animals to avoid risk of choking or suffocation.

## Furniture components:

1	Sofa Base	x1
2	Back Cushion	x3
3	Metal Leg	x4
4	Middle Leg	x2

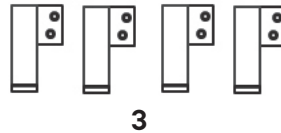
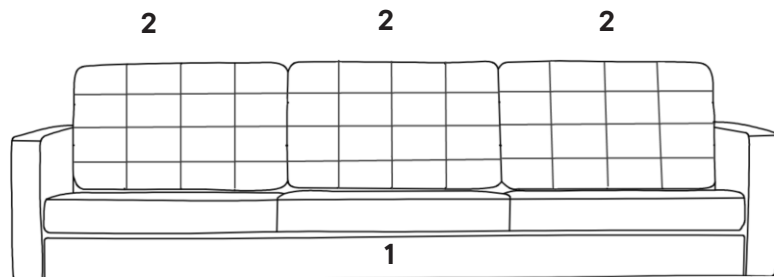

## Provided hardware:

A		Bolt M8 x 35mm	x12
B		Flat Washer M8	x12
C		Allen Wrench M8	x1

Wait!

Missing parts or hardware? Need assistance?  
Contact us before returning your item. We're here to help!  
609.256.9000 • cs@modway.com

# Step 1

## COMPONENTS

1	Sofa Base	x1
3	Metal Leg	x4
4	Middle Leg	x2

## HARDWARE

A	Bolt M8 x 35mm	x12
B	Flat Washer M8	x12
C	Allen Wrench M8	x1

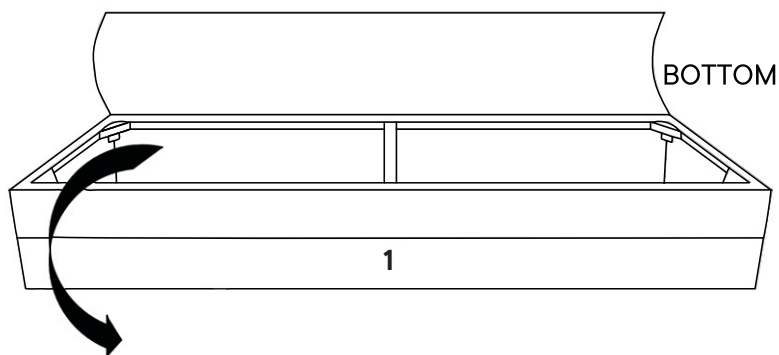

Unzip the bottom cover and locate the Metal Leg (3) + Middle Leg (4) + Hardware package.

# Step 2

## COMPONENTS

1	Sofa Base	x1
3	Metal Leg	x4
4	Middle Leg	x2

## HARDWARE

A	Bolt M8 x 65mm	x12
B	Flat Washer M8	x12
C	Allen Wrench M8	x1

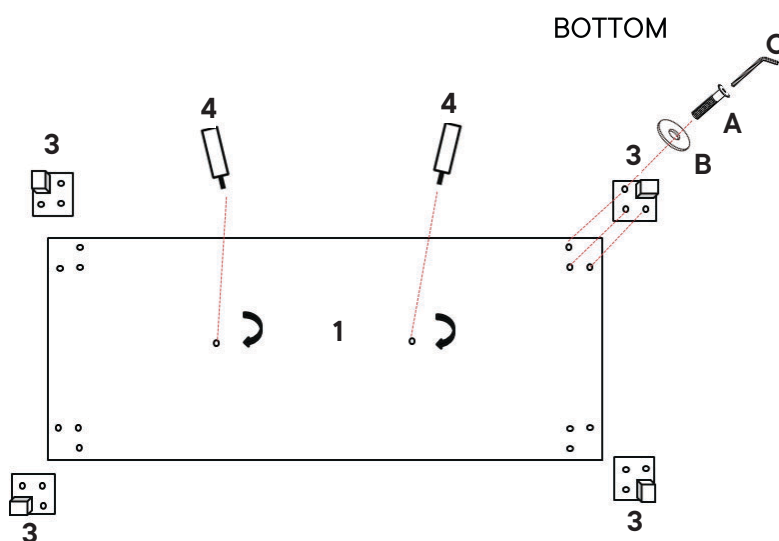

# Step 3

## COMPONENTS

2 Back Cushion x3

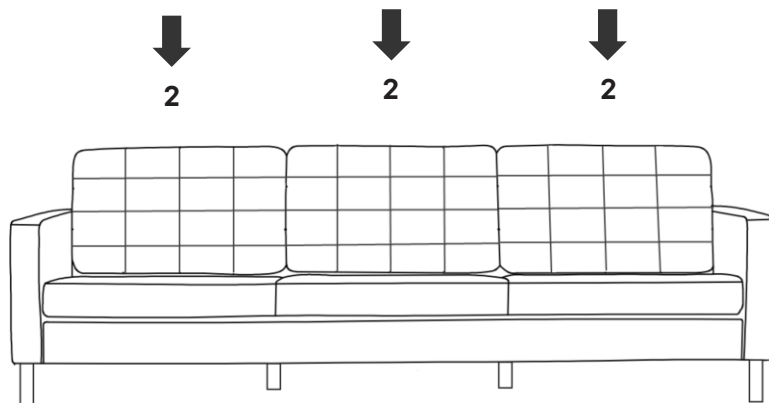

# Great job!

Your sofa is complete and ready to enjoy.

## ♥ CARING FOR YOUR ITEM

Indoor use only.

Not contract grade.

Clean using a non-abrasive cloth and a mild cleaner.

Never use harsh chemicals, as they could damage the finish or integrity of the item.

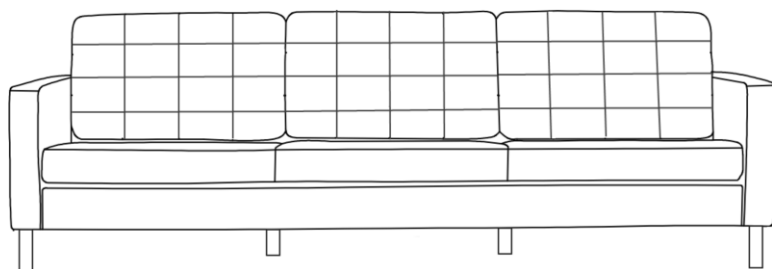

CONNECT WITH US!   

Tag us [@modway\\_furniture](#) and [#modway](#) for a chance to be featured.

# ASSEMBLY INSTRUCTIONS

# EEI-3388

V1.09.01.23

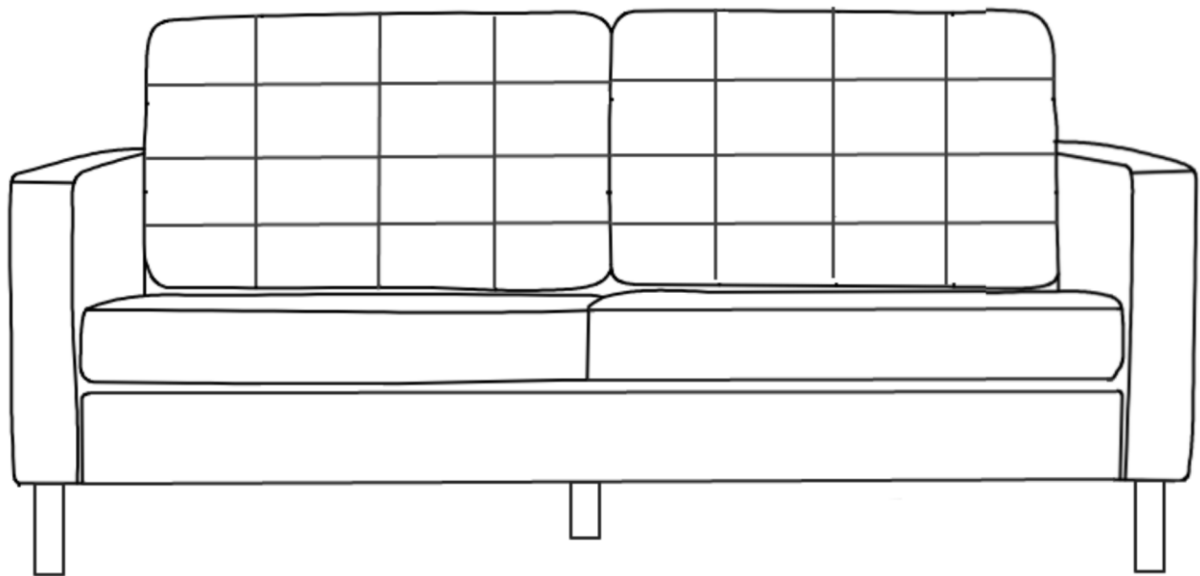

**Questions? Contact us!**

609.256.9000 • [cs@modway.com](mailto:cs@modway.com)  
[www.modway.com](http://www.modway.com)

\*modway

# Let's get started!

\*modway



Read through all of the instructions before starting



Care instructions are listed in the last step of this manual



Approx. 30 minutes assembly time



Make sure you have all parts and components before discarding any packing materials



2 people recommended for assembly

**Only use hand tools to assemble this item.** Do not use power tools. Do not tighten bolts or screws completely until all hardware is lined up and inserted into the holes.

Do not over-tighten screws and bolts to avoid stripping the hardware or cracking the item.

Assemble your item on a flat, carpeted area, with plenty of space to work. This will prevent damage and scratches to your floors or the item while you're assembling the product.



Keep all components and packaging out of reach of children or animals to avoid risk of choking or suffocation.

## Furniture components:

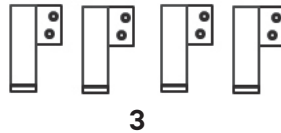
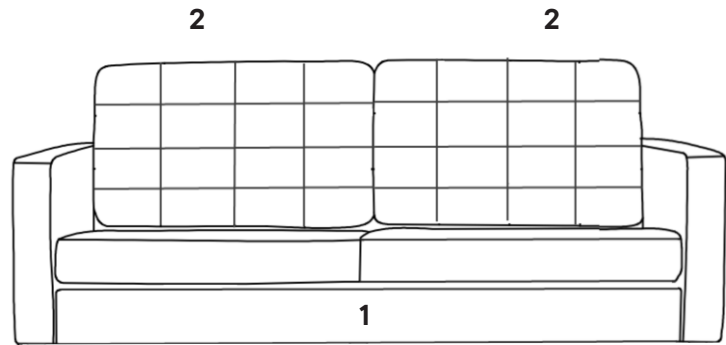
1	Loveseat Base	x1
2	Back Cushion	x2
3	Metal Leg	x4
4	Middle Leg	x1



## Provided hardware:

A		Bolt M8 x 35mm	x12
B		Flat Washer M8	x12
C		Allen Wrench M8	x1

Wait!

Missing parts or hardware? Need assistance?  
Contact us before returning your item. We're here to help!  
609.256.9000 • cs@modway.com

# Step 1

## COMPONENTS

1	Loveseat Base	x1
3	Metal Leg	x4
4	Middle Leg	x1

## HARDWARE

A	Bolt M8 x 35mm	x12
B	Flat Washer M8	x12
C	Allen Wrench M8	x1

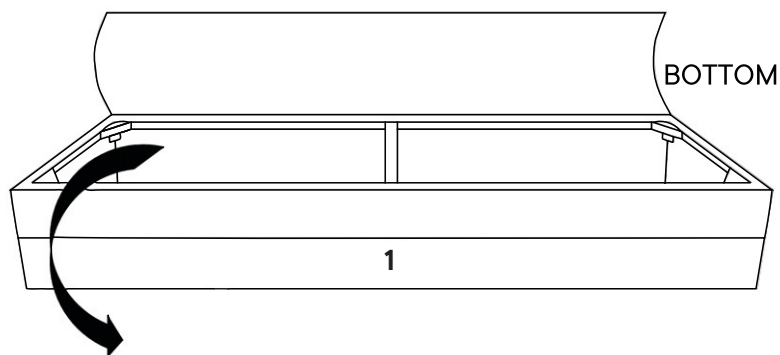

Unzip the bottom cover and locate the Metal Leg (3) + Middle Leg (4) + Hardware package.

# Step 2

## COMPONENTS

1	Loveseat Base	x1
3	Metal Leg	x4
4	Middle Leg	x1

## HARDWARE

A	Bolt M8 x 65mm	x12
B	Flat Washer M8	x12
C	Allen Wrench M8	x1

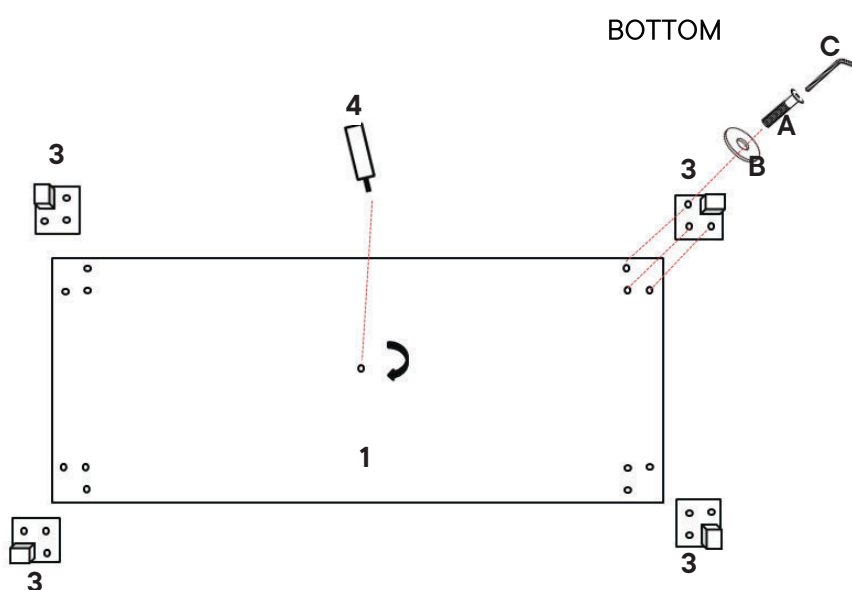

# Step 3

## COMPONENTS

2 Back Cushion x2

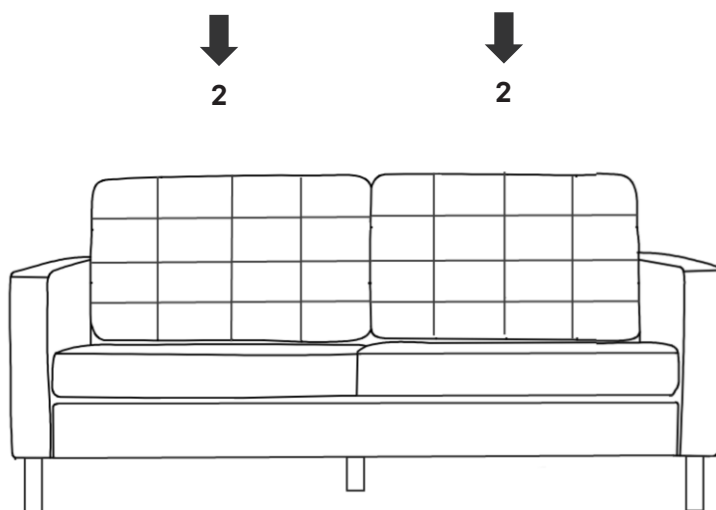

# Great job!

Your loveseat is complete and ready to enjoy.

## ♥ CARING FOR YOUR ITEM

Indoor use only.

Not contract grade.

Clean using a non-abrasive cloth and a mild cleaner.

Never use harsh chemicals, as they could damage the finish or integrity of the item.

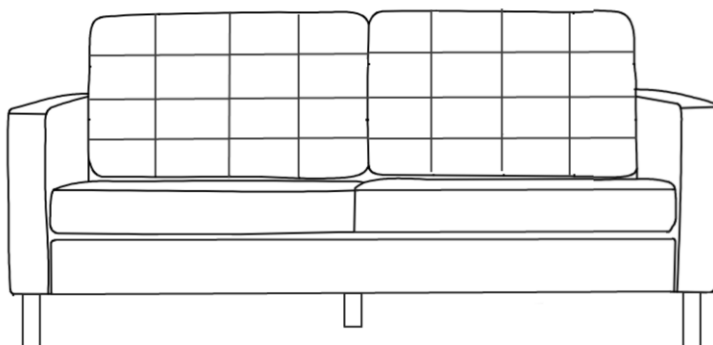

CONNECT WITH US!   

Tag us @modway\_furniture and #modway for a chance to be featured.

# ASSEMBLY INSTRUCTIONS

# EEI-3391

V1.09.01.23

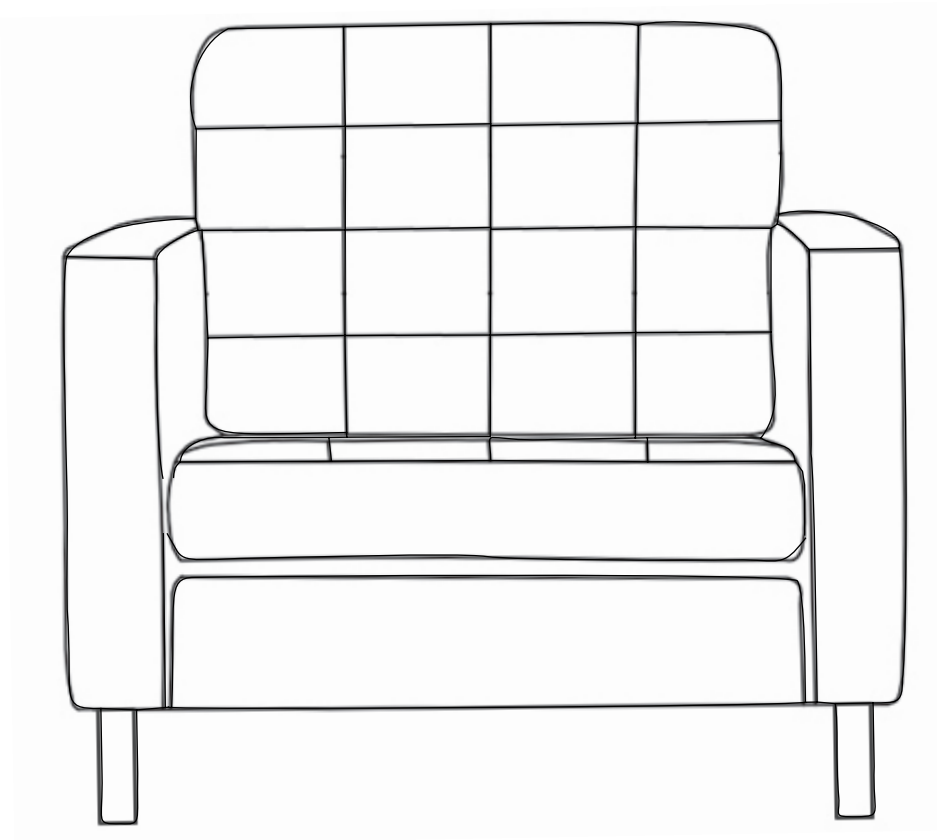

**Questions? Contact us!**

609.256.9000 • [cs@modway.com](mailto:cs@modway.com)  
[www.modway.com](http://www.modway.com)

\*modway



Read through all of the instructions before starting



Care instructions are listed in the last step of this manual



Approx. 30 minutes assembly time



Make sure you have all parts and components before discarding any packing materials



2 people recommended for assembly

**Only use hand tools to assemble this item.** Do not use power tools. Do not tighten bolts or screws completely until all hardware is lined up and inserted into the holes.

Do not over-tighten screws and bolts to avoid stripping the hardware or cracking the item.

Assemble your item on a flat, carpeted area, with plenty of space to work. This will prevent damage and scratches to your floors or the item while you're assembling the product.



Keep all components and packaging out of reach of children or animals to avoid risk of choking or suffocation.

## Furniture components:

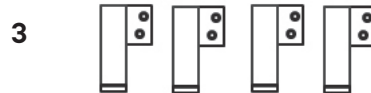
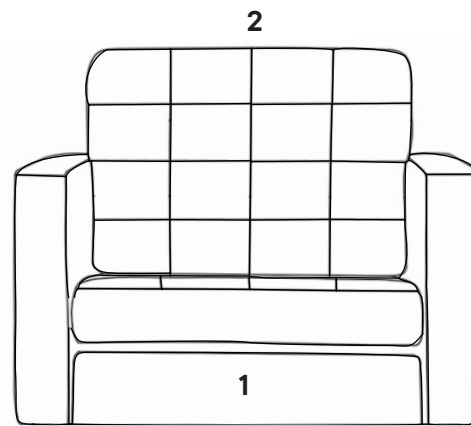
1	Armchair Base	x1
2	Back Cushion	x1
3	Metal Leg	x4



## Provided hardware:

A		Bolt M8 x 35mm	x12
B		Flat Washer M8	x12
C		Allen Wrench M8	x1

**Wait!**

Missing parts or hardware? Need assistance?  
Contact us before returning your item. We're here to help!  
609.256.9000 • cs@modway.com

# Step 1

## COMPONENTS

- ① Armchair Base x1
- ③ Metal Leg x4

## HARDWARE

- Ⓐ Bolt M8 x 35mm x12
- Ⓑ Flat Washer M8 x12
- Ⓒ Allen Wrench M8 x1

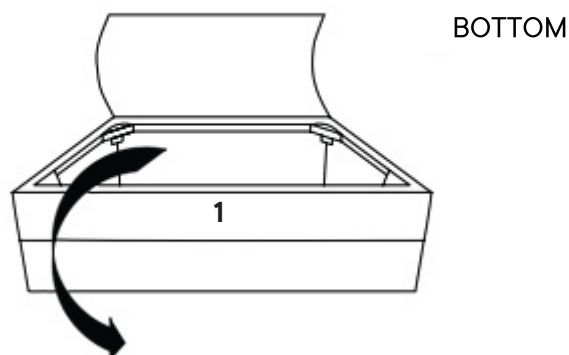

Unzip the bottom cover and locate the Metal Leg (3) + Hardware package.

# Step 2

## COMPONENTS

- ① Armchair Base x1
- ③ Metal Leg x4

## HARDWARE

- Ⓐ Bolt M8 x 65mm x12
- Ⓑ Flat Washer M8 x12
- Ⓒ Allen Wrench M8 x1

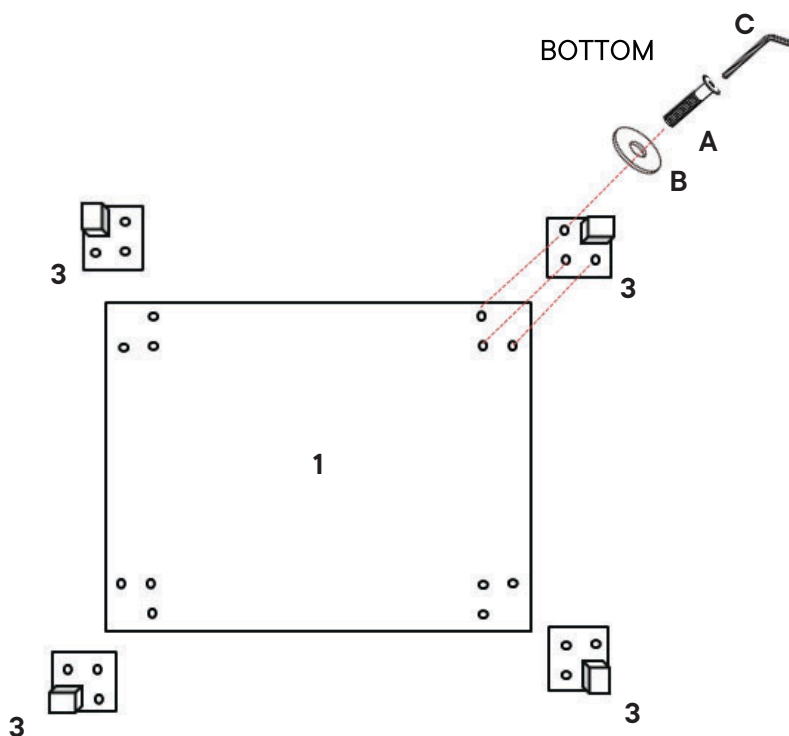

# Step 3

## COMPONENTS

2 Back Cushion x1



2

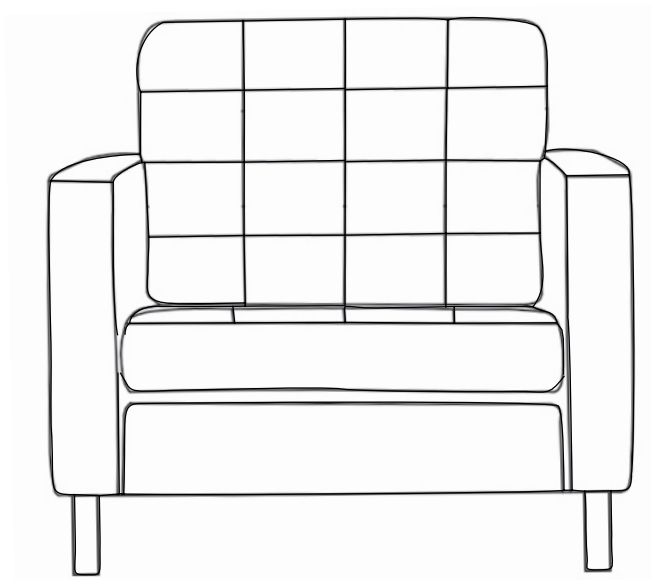

# Great job!

Your armchair is complete and ready to enjoy.

## ♥ CARING FOR YOUR ITEM

Indoor use only.

Not contract grade.

Clean using a non-abrasive cloth and a mild cleaner.

Never use harsh chemicals, as they could damage the finish or integrity of the item.

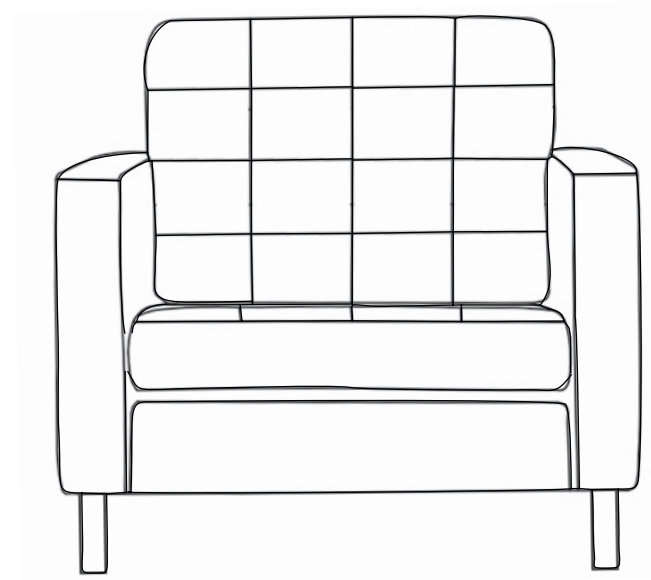

CONNECT WITH US!   

Tag us @modway\_furniture and #modway for a chance to be featured.