

DEEP SEATING SOFA 1 SEATER

CODE SKU NO : EEI-1143-NAT-WHI

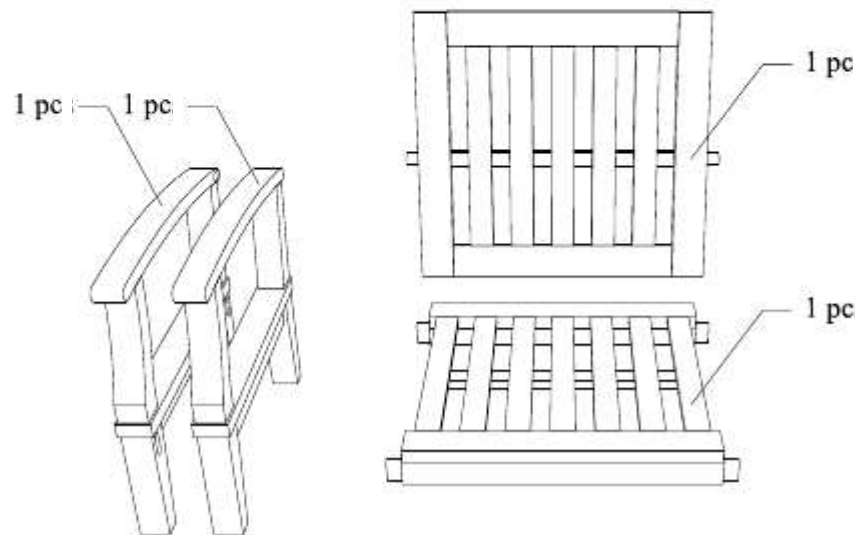

1

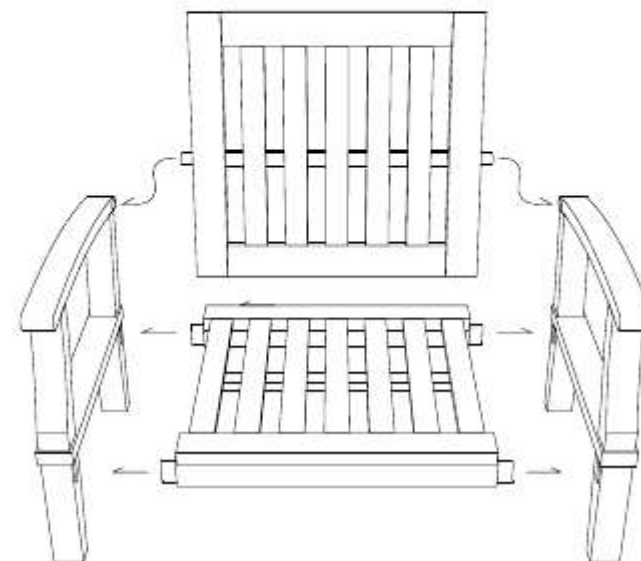

2

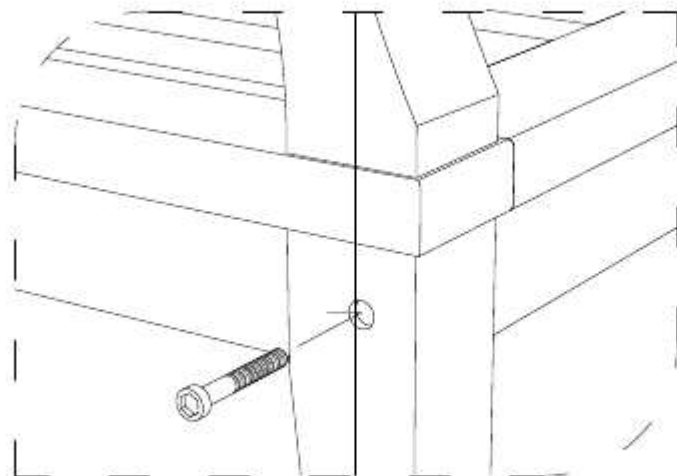

3

**STAINLESS STEEL
HARDWARE**



M 6 X 7cm = 8 pcs



Allen Wrench M4 = 1 pc



4

DEEP SEATING RIGHT

CODE SKU NO : EEI-1148-NAT-WHI

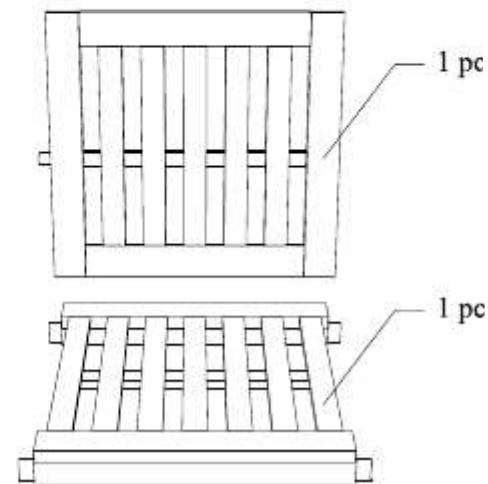
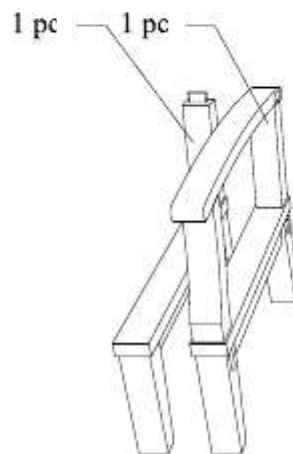
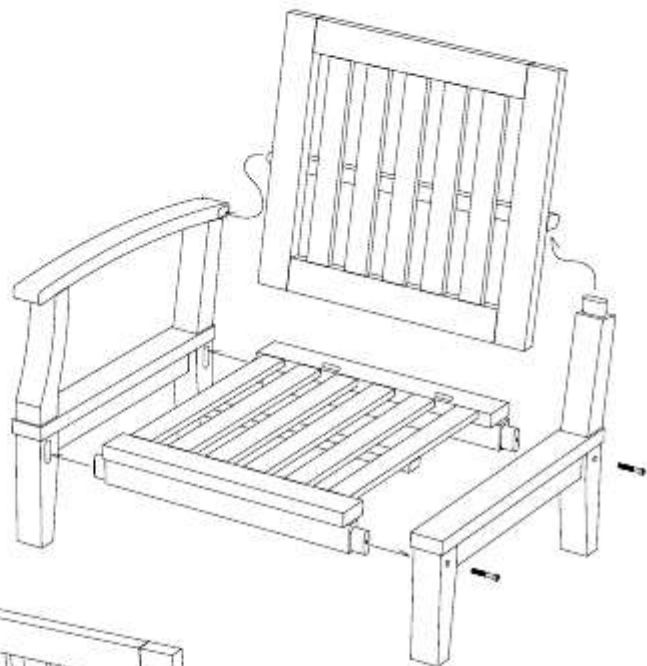

1

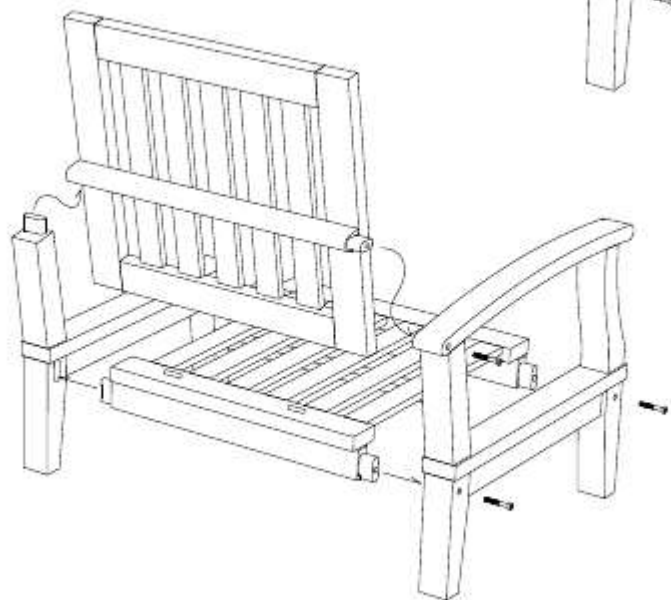

STAINLESS STEEL HARDWARE

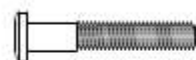

M 6 X 4cm = 1 pc



M 6 X 7cm = 6 pcs



Allen Wrench M4= 1 pc



3

2

DEEP SEATING LEFT

CODE SKU NO : EEI-1149-NAT-WHI

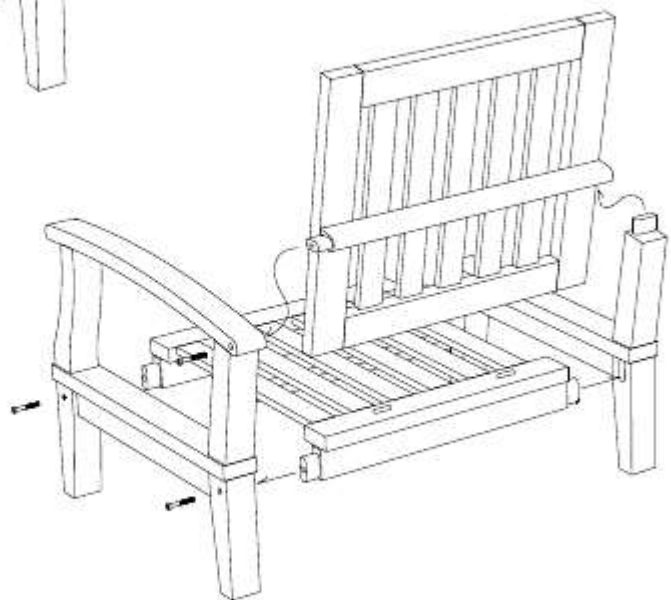
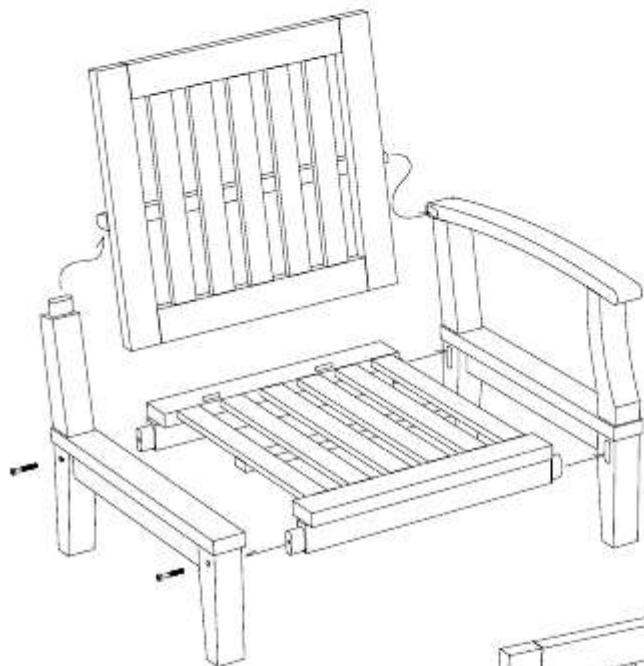

2

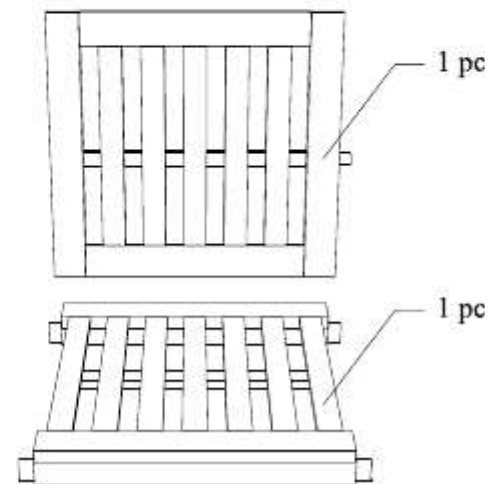
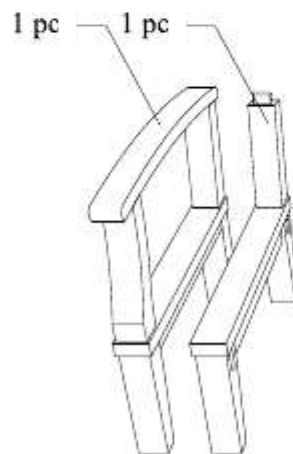

1

STAINLESS STEEL HARDWARE

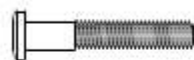

M 6 X 4cm = 1 pcs



M 6 X 7cm = 6 pcs



Allen Wrench M4= 1 pc



3

DEEP SEATING CENTER UNIT

CODE SKU NO : EEI-1150-NAT-WHI

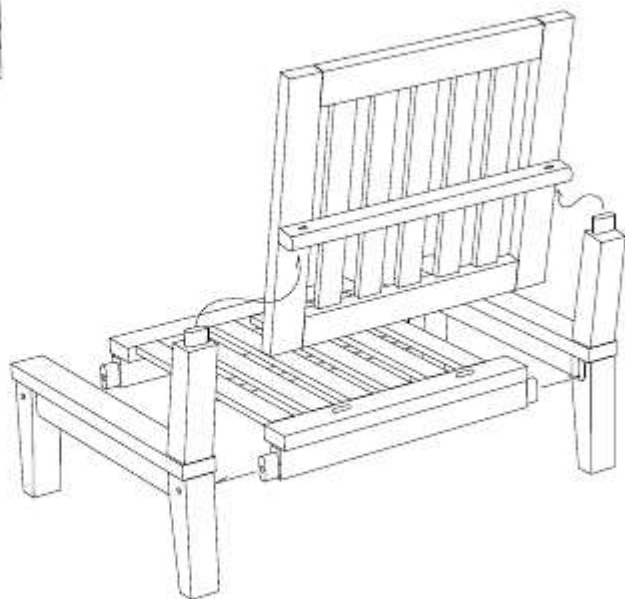
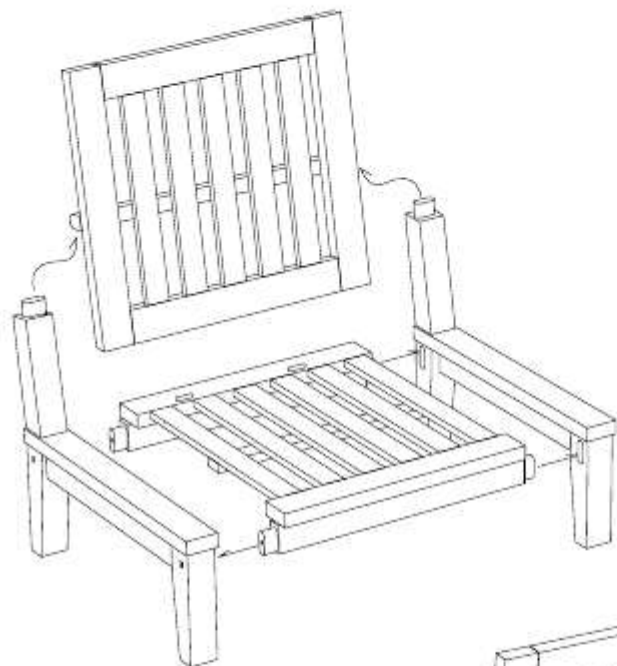

2

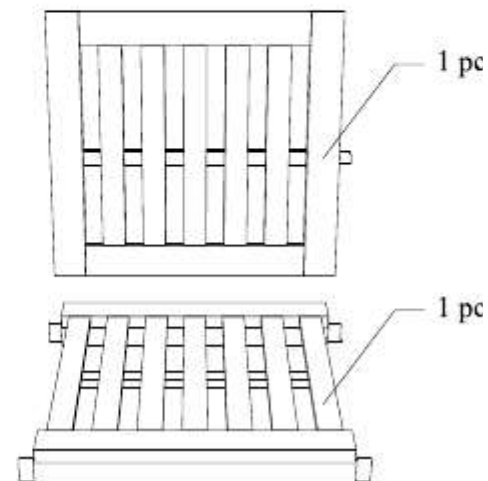
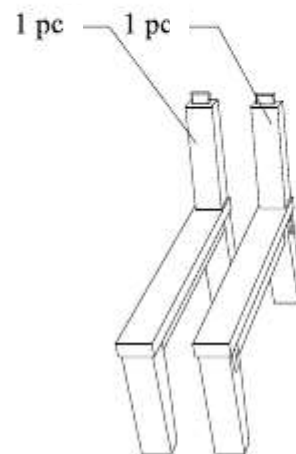

1

STAINLESS STEEL HARDWARE

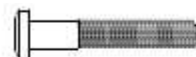

M 6 X 4cm = 2 pcs



M 6 X 7cm = 4 pcs



Allen Wrench M4 = 1 pc



3

OTTOMAN

CODE SKU NO : EEI-1152-NAT-WHI

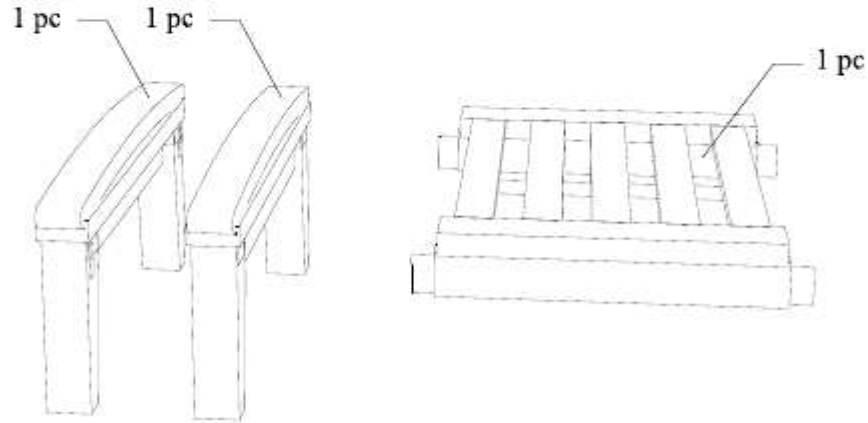

1

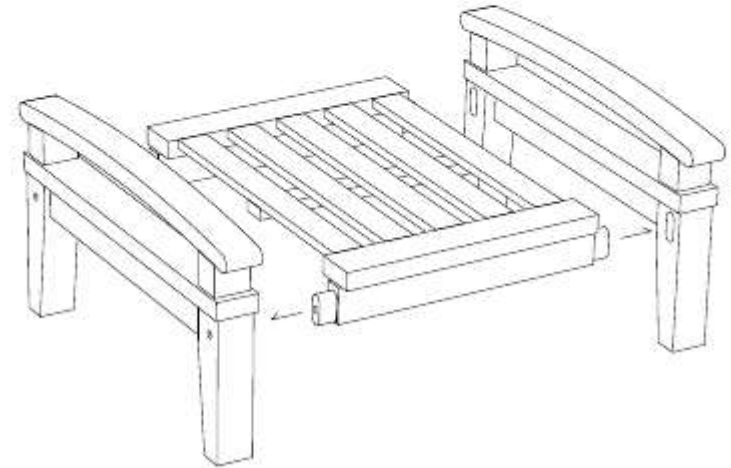

2

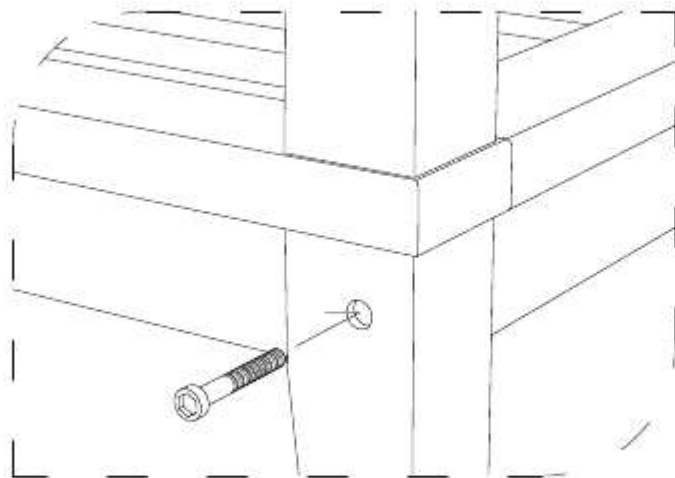

3

STAINLESS STEEL HARDWARE



M 6 X 7cm = 4 pcs



Allen Wrench = 1 pc

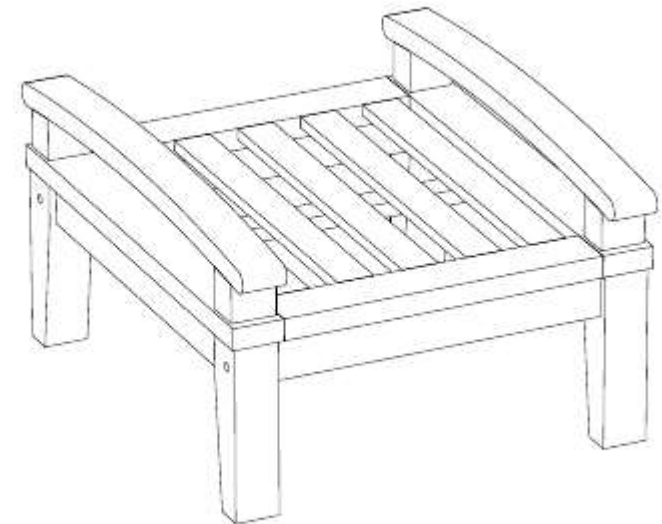

4

COFFEE TABLE

CODE SKU NO : EEI-1154-NAT

modway

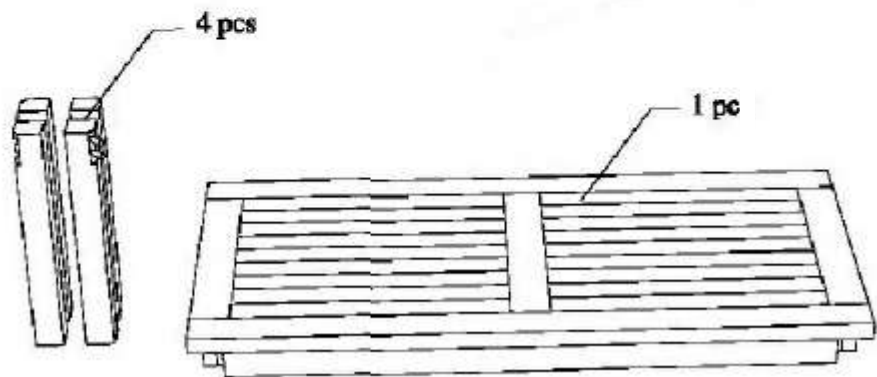

1

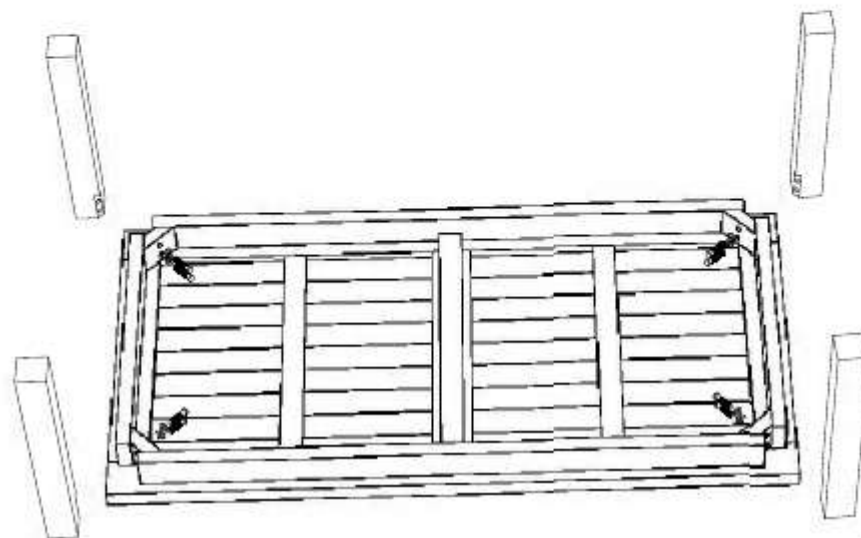

2

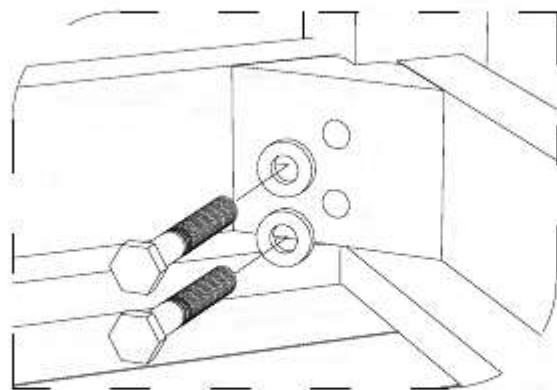

STAINLESS STEEL HARDWARE



M 8 X 6cm = 8 pcs



Flat Washer M 8 = 8 pcs

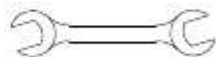

Open Wrench M5 = 1 pc

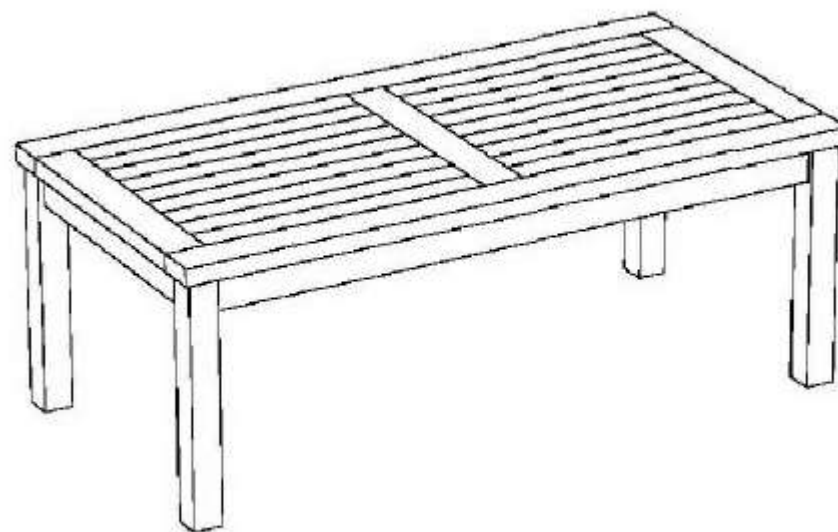

4