

TOV



Follow us!

Show your new purchase some love by tagging it on our Instagram!

 @tovfurniture

 516-888-3355

 hello@tovfurniture.com

 www.tovfurniture.com

If the future is female—your furniture should be, too. No mahogany in sight. Sexy settees shaped like lips. Price points for any budget. At TOV, we do things differently.

TOV

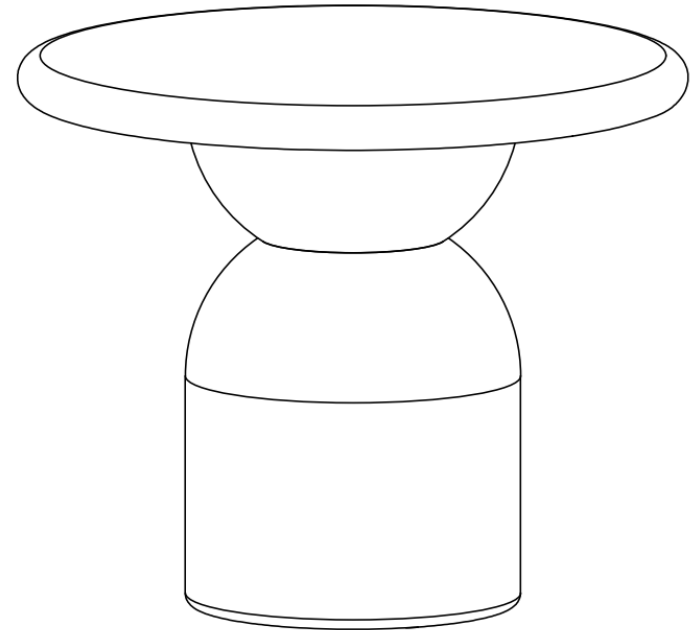

Cynthia Concrete Side Table

DON'T BE BORING.

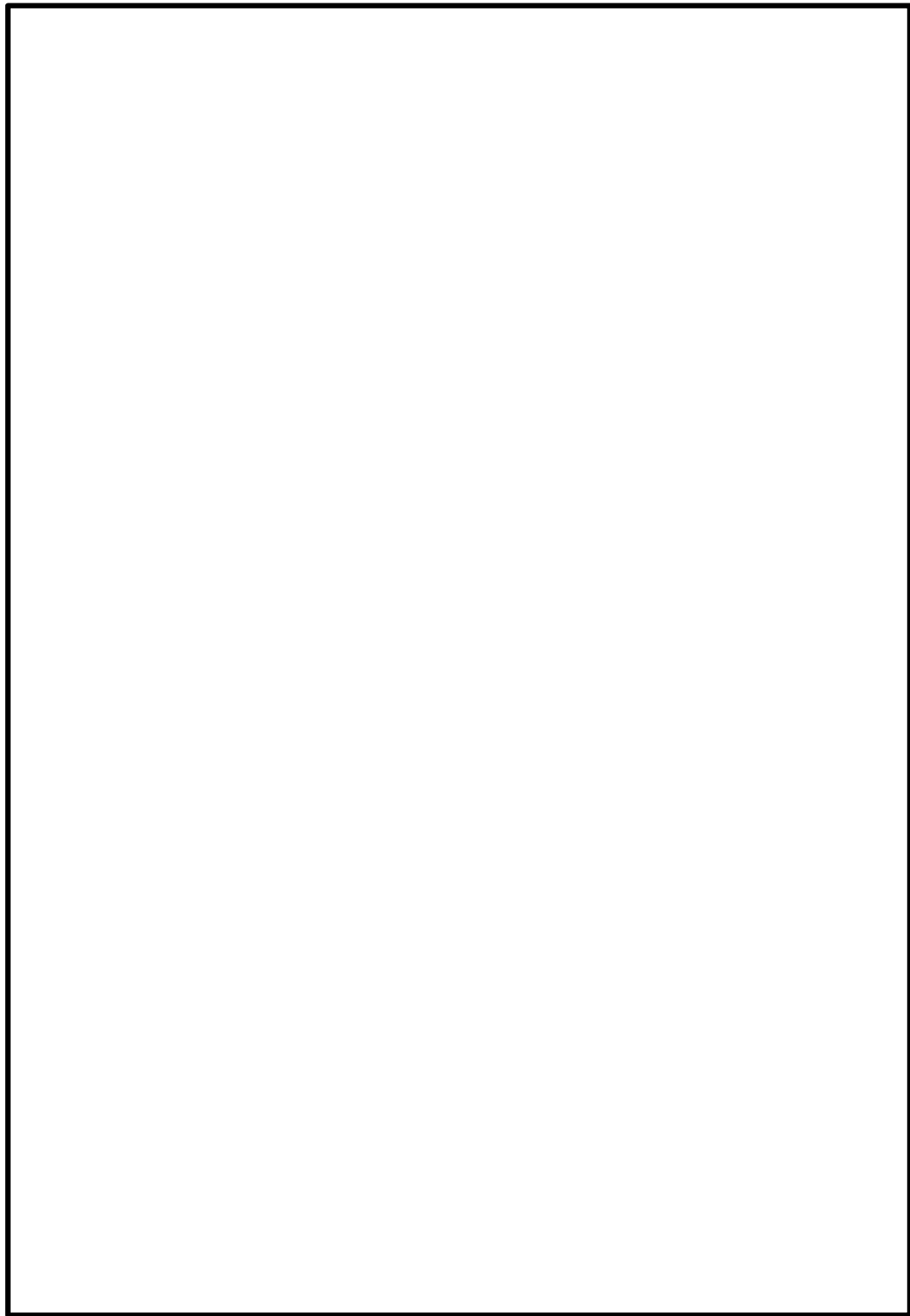
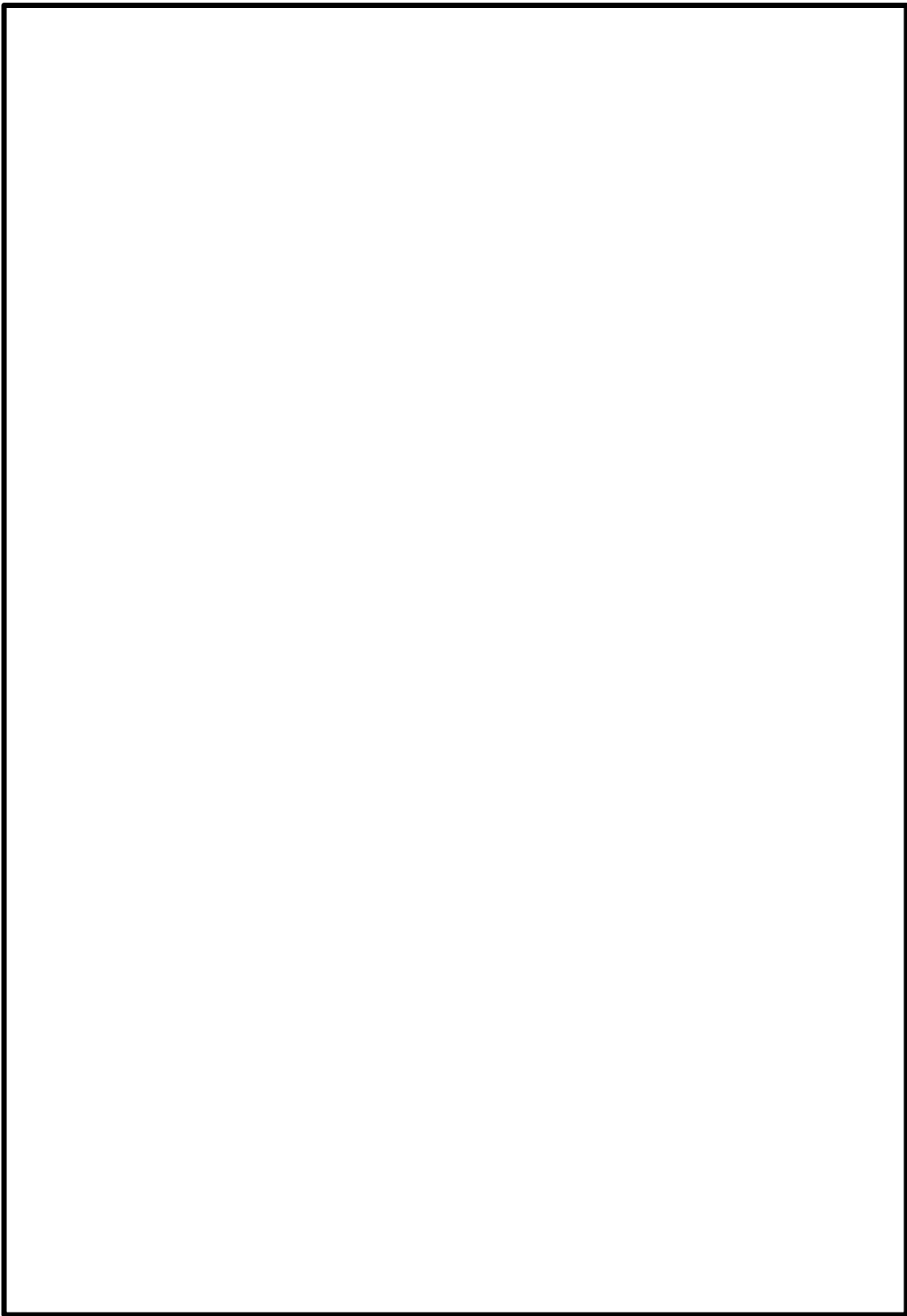

Step 4

A. Complete!

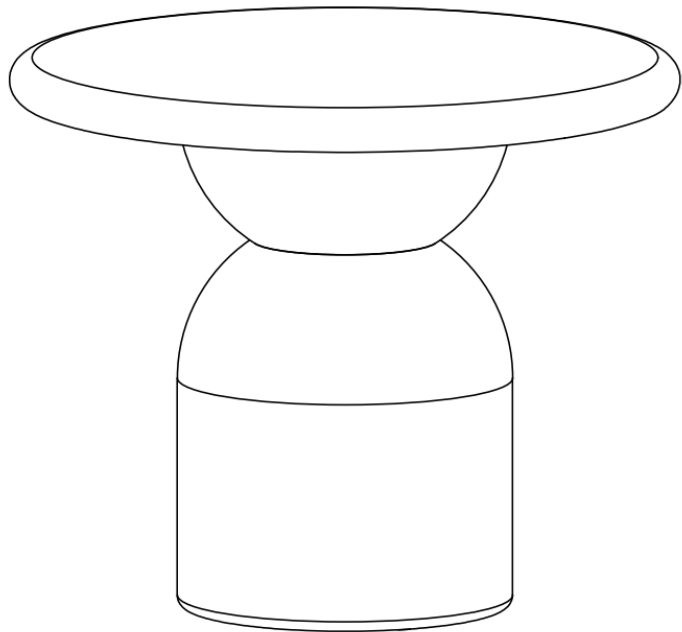

Stuck?
Contact our team @ 516-888-3355
Scan for product care!



Hardware and Components

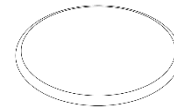

..... (A) Top x 1pcs

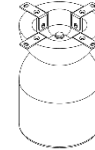

..... (B) Legs x 1pcs

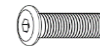

..... (C) Bolt M8*20 x 4pcs



..... (D) Washer $\varnothing 22*2$ x 4pcs



..... (E) Allen Key x 1pcs

Step 1
Open box of hardware and legs.

This hardware box will be a smaller box inside of the main box. Look for the red streamer.



Step 2

- 1) Place the table top (A) facing down on the floor.
- 2) Secure table base (B) to the table top (A) with hardwares (C) & (D) by wrench (E)

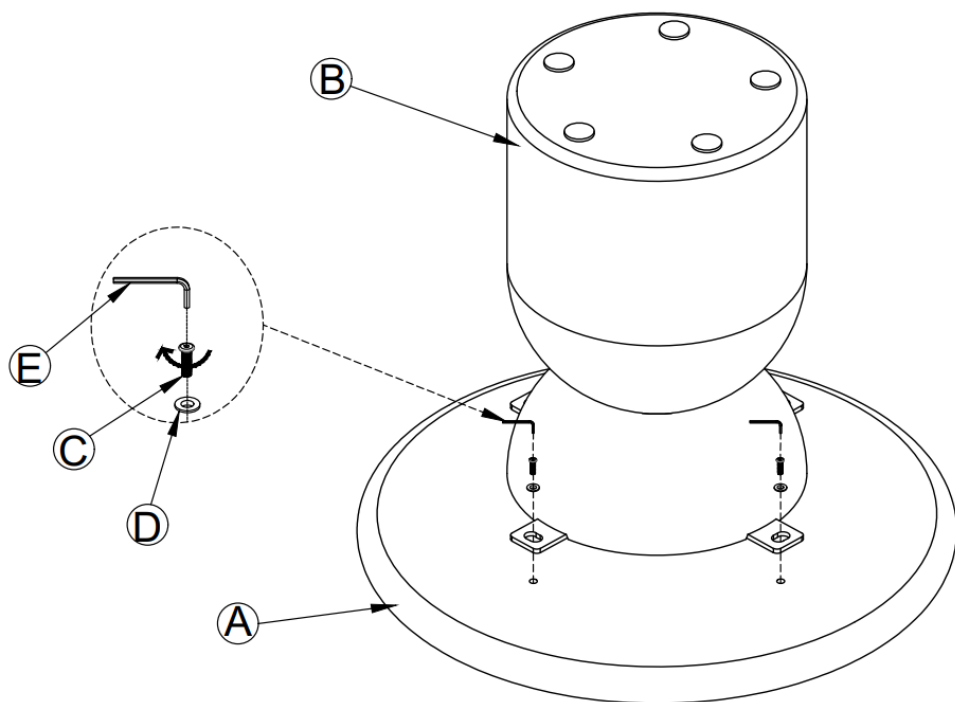

Please fasten the screws/bolts at 70%, and fully tighten them after all screw/bolts are fully in place.

Step 3

Turn over the table facing up after complete installation.

