



TOV





Follow us!

Show your new purchase some love by tagging it on our Instagram !

 @tovfurniture

 516-888-3355

 hello@tovfurniture.com

 www.tovfurniture.com

If the future is female—your furniture should be, too. No mahogany in sight. Sexy settees shaped like lips. Price points for any budget. At TOV, we do things differently.

TOV

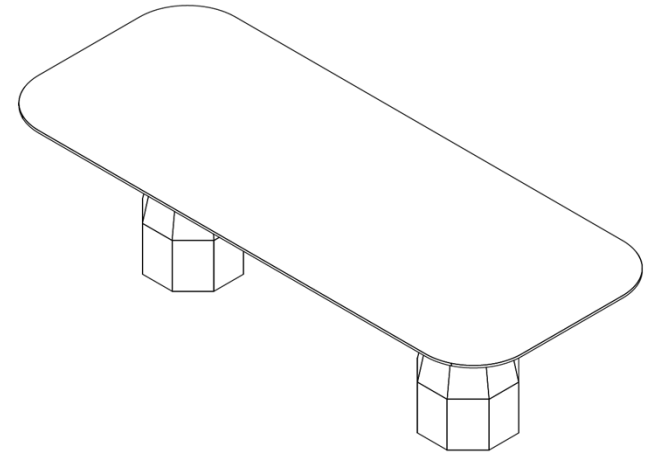

**Brocha 106" Long
Ash Dining Table**

DON'T BE BORING.

FINISH

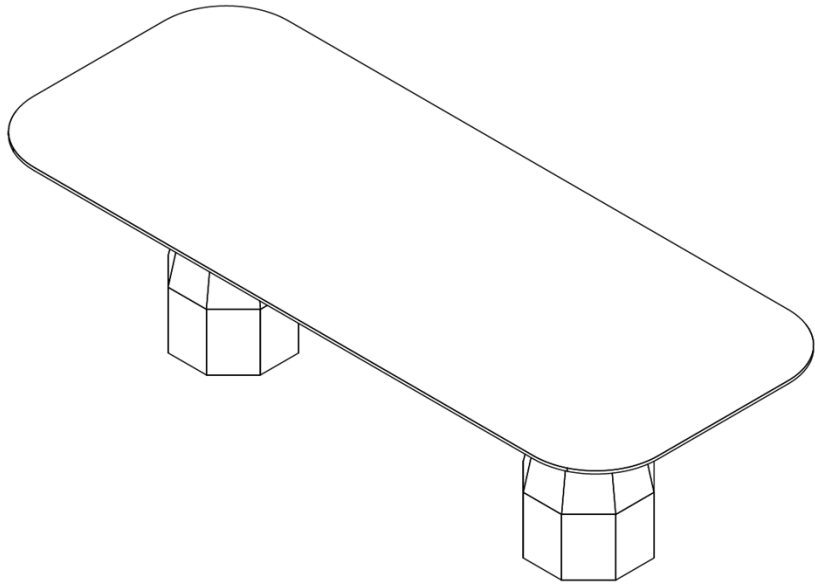

Stuck?
Contact our team @ 516-888-3355

Scan for product care!



Hardware and Components



A x1pc

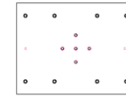

B x2pcs



C x2pcs



D Bolt M6*35 x26pcs



E Flat washer Ø18x2 x26pcs



F Spring washer Ø10x2 x26pcs



G Allen key x1pc

STEP 1

Open box of hardware and legs.

This hardware box will be a smaller box inside of the main box. Look for the red streamer.



STEP 2

Attach the support panel (B) to the top of base (C). Align with the pre-drilled holes. Use hardware (D), (E) and (F) with Allen key (G) to tighten all bolts. Repeat the same steps for the remaining table base.

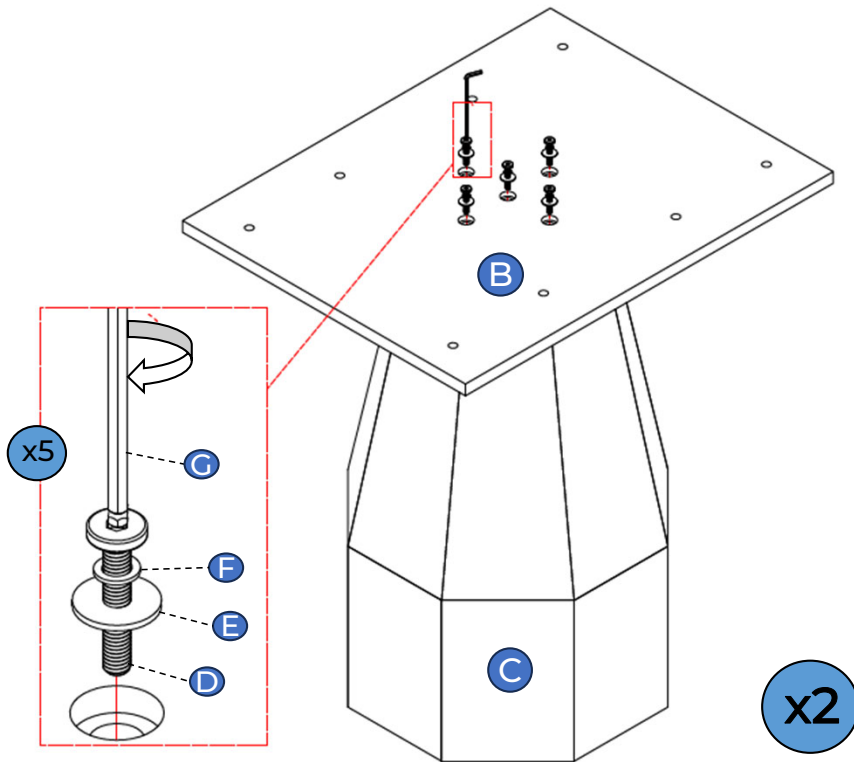

Please fasten the bolts at 70%, and fully tighten them after all bolts are fully in place.

STEP 3

A). Place the table top (A) face upside down on a clean, non marring surface (i.e. packing foam)
B). Attach assembled table base from step 2 on the table top (A). Align with the pre-drilled holes. Then secure the base to table top by using hardware (D),(E),(F) with Allen Key (G).

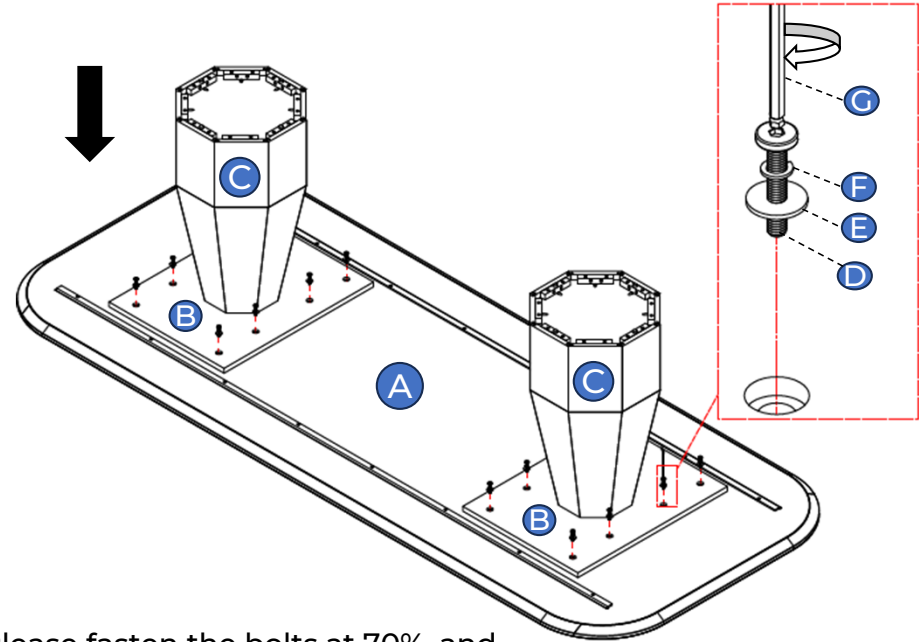

Please fasten the bolts at 70%, and fully tighten them after all bolts are fully in place.

STEP 4

With help, turn the table over so it is standing upright position. Adjust the levellers on the bottom leg if necessary to level the table. Assembly is completed.

